



LEUCOS[®]
BRIGHT IN ELEGANCE

PRICE LIST 2019-2020



INDEX BY APPLICATION/INDICE PER APPLICAZIONE

TABLE/TAVOLO	FLOOR/TERRA	PENDANT/SOSPENSIONE	PENDANT/SOSPENSIONE
AELLA T	14	AYERS TR 38	30
AELLA MINI T 30	15	CHEOPE TR	30
AELLA BOLD T	15	KATANA TR	31
AELLA THIN T	16	STACKING B TR	31
AYERS T 19	16	STACKING C TR	31
AYERS T 38	16	STACKING D TR	32
CHEOPE T 32	17	THE GREAT JJ TR	32
CHEOPE T 42	17	THE GREAT JJ OUTDOOR TR	33
CLOCHE T	17	VITTORIA TR 1	33
CUBI ZERO T 11	18	VITTORIA TR 1/C	34
CUBI ZERO T 16	18		
FAIRY T C	18		
JJ T-P	19		
LEVA T	20		
LEVA EVO T	20		
MICENE T	20		
MYSTÈS T	21		
PARALUME MINI T	21		
PARALUME P (SMALL) T	21		
PARALUME M (MEDIUM) T	22		
PARALUME G (BIG) T	22		
SPHERA T 3/29	22		
SPHERA T 3/37	23		
SPHERA T 3/45	23		
SPRING T	23		
SUMMER T	24		
UOVO T 46	24		
VITTORIA T 1	24		
VITTORIA T 1/C	25		
		AELLA S	38
		AELLA MINI S 30	38
		AELLA BOLD S	38
		AELLA THIN S	39
		AKI S	39
		ALMA S 30	39
		ALMA S 60	40
		ARIA S 18	40
		ARIA S 36	41
		ATELIER S	41
		ATHENA S 1	42
		AXEL S	42
		AYERS S	43
		AYERS S 38	43
		BEAMER S 11	43
		BEAMER S 11 - I	44
		BEAMER S 11 - R3	44
		BEAMER S 17	45
		BEAMER S 17 - I	45
		BEAMER S 17 - R3	46
		BOHEME L 6	46
		BOHEME L 12	47
		BOLERO L 6	47
		BOLERO L 9	48
		CLASS S 40	48
		CLASS S 60	49
		CLOCHE S	49
		CLOCHEF S	50
		CUBI S 11	50
		CUBI S 16	51
		DELUXE S 35	51
		DELUXE S 50	52
		ELYSEE L 12	52
		ETHER S	53
		ETHER S 90	53
		ETHER S 150	53
		FAIRY S C	54
		FAIRY S C - I	54
		FAIRY S C - D3	55
		FAIRY S G	55
		FAIRY S G - I	56
		FAIRY S G - D3	56
		FAIRY S S	57
		FAIRY S S - I	57
		FAIRY S S - D3	58
		FELIX S 47	58
		FELIX S 55	59
		FLECHA S	59
		GLÒ INCASSO I	60
		GLÒ PLAFONIERA PL	60
		GLÒ S	61
		GLÒ S/I	61
		GOLF S 3	62
		GOLF S 3/SP	62
		IXI S	63
		KEYRA S 30	63
		KEYRA S 60	64
		KUK S	64
		LILITH S 40	65
		LILITH S 55	65
		LILITH S 70	65
		MERCURE S	66
		MODULO S 35	66
		MYSTÈS S	67
		NIA S	67
		NIA S 3	68
		NIA S 6	68
		NIA S 12	69
		ORLEANS L 12	69
		REED S 90	70
		REED S 135	70
		REED 90 (canopy kit for composition)	71
		REED 135 (canopy kit for composition)	71
		REED 180 (canopy kit for composition)	72
		REED 90 PL-S (connection kit)	72
		REED 135 PL-S (connection kit)	72
		REED 90 (glass for composition)	73
		REED 135 (glass for composition)	73
		SERENISSIMA L 6	73
		SERENISSIMA L 12	74
		SIBILLA S 30	74
		SIBILLA S 40	75
		SPHERA S 29	75
		SPHERA S 37	76
		SPHERA S 45	76
		SPORE S	77
		SPRING S	77
		SUMMER S	78
		THE GREAT JJ S	78
		TRIGONA S	79
		VOLTA S 120	79
		VOLTA S 160	79
		WITCH S	80
		3517 S1	80
		3517 S2	80

INDEX BY APPLICATION/INDICE PER APPLICAZIONE

WALL/PARETE	WALL-CEILING/ PARETE-SOFFITTO	CEILING/SOFFITTO	RECESSED/INCASSO
AA P 12	84	BETA SMALL P-PL	98
AA P 20	84	BETA BIG P-PL	98
ABBAY P	84	CUBI P-PL 11	99
ALA PICCOLA P 16	85	CUBI P-PL 16	100
ALA P 25	85	CUBI P-PL 28	100
ALIAS P 15	85	FELIX MINI P-PL	101
ALIAS P 35	86	FELIX P-PL 35	101
ATELIER P	86	FELIX P-PL 47	101
BLOCK P 14	86	FELIX P-PL 55	101
BLOCK P 29	87	KEYRA P-PL 30	102
BLOCK P 65	87	KEYRA P-PL 60	102
BLOCK P 100	87	KUK P-PL	102
BOLERO P 2	88	LOOP-LINE P-PL 32	103
CELINE P	88	MERCURE P-PL	103
CELINE P 35	88	MILD P-PL	103
CLASS P	89	NUBIA P-PL 45	104
GOLF P 1	89	NUBIA P-PL 60	104
GOLF P 1/SP	89	PLANET P-PL 32	104
LILITH P	90	PLANET P-PL 48	105
LINK P	90	PLANET P-PL 65	105
MODULO P 35	90	SELIS P-PL 35 T	105
OPI P	91	SELIS P-PL 45 T	106
ORLEANS P	91	STONE P-PL	106
PASCALE P 40	91	TRECENTOESSANTAGRADI P-PL 120	106
PUCK P	92	TRECENTOESSANTAGRADI P-PL 200	107
SERENISSIMA P	92	WIMPY P-PL 16	107
SPRING P	92	WIMPY P-PL 32	107
SUMMER P	93		
VITTORIA P 2	93		
		ATELIER PL 32	112
		BOLERO PL 75	112
		DELUXE PL 35	112
		DELUXE PL 50	113
		ELYSEE PL 60	113
		LILITH PL 40	113
		LILITH PL 55	114
		LILITH PL 70	114
		LOOP-LINE PL 60	114
		MODULO PL 35	115
		ORLEANS PL	115
		PASCALE PL 30	115
		PASCALE PL 40	116
		REED PL 90	116
		REED PL 135	116
		REED PL 180	117
		SPHERA PL 29	117
		SPHERA PL 37	117
		649 PL 45	118
		649 PL 65	118
		BAIA I	122
		DAY I	123
		DIAMANTE I	123
		DISK I	124
		DROP I	124
		HELIOS I	125
		IGEA 2 I	125
		ISIDE 2 I	126
		MIRA 2 I	126
		ONLY I	127
		PEGASO I	127
		POLAR I	128
		QUASAR I	128
		SIDERAL I	129
		SITH I	129
		SPIRA I	130
		STAR I	131
		STEP I	131
		SUN I	132
		VAN 2 I	132
		SD 802 I	133
		SD 803 I	133
		SD 902 I	133
		SD 903 I	134
		SD 081 N I	134
		SD 081V N I	134
		SD 084 N I	135
		SD 085 I	135
		SD 086 I	135
		SD 087 I	136
		SD 087V I	136

AA
pag 84 84

ABBEY
pag 84

AELLA
pag 38 38 39 38 15 15 16 14

AKI
pag 39

ALA
pag 85 85

ALIAS
pag 86 86

ALMA
39 40

ARIA
pag 40 41

ATELIER
pag 41 112 86

ATHENA
pag 42

AXEL
pag 42

AYERS
pag 43 43 16 16 30

BEAMER
pag 43 44 44 45 45 46

BETA
pag 98 98

BLOCK
pag 87 87 87 87

BOHEME
pag 46 47

BOLERO
pag 47 47 88 112

CELINE
pag 88 88

CHEOPE
pag 17 17 30

CLASS
pag 48 49 89

CLOCHE
pag 49 17

CLOCHEF
pag 50

CUBI
pag 50 51 98 99 100 18 18

DELUXE
pag 51 52 112 113

ELYSÉE

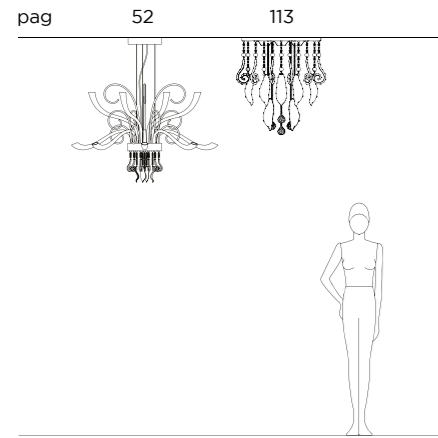

ETHER

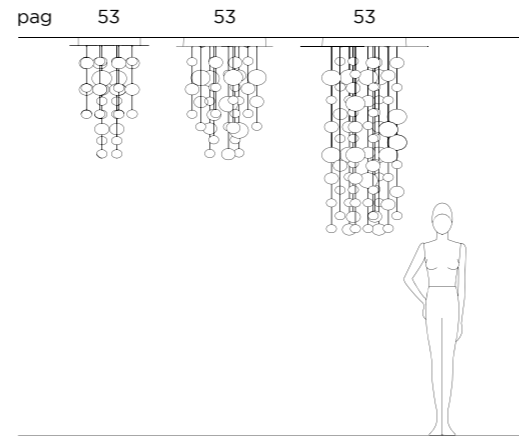

FAIRY

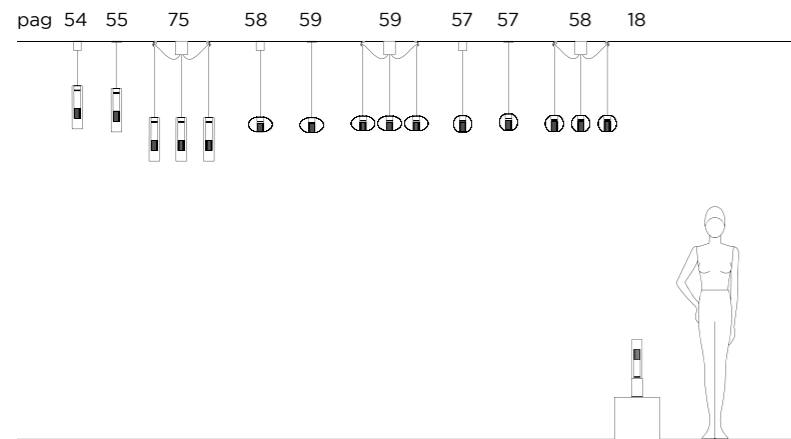

FELIX

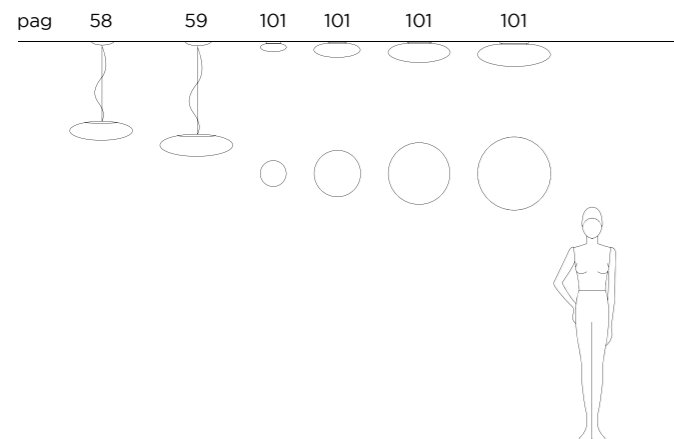

GLÒ

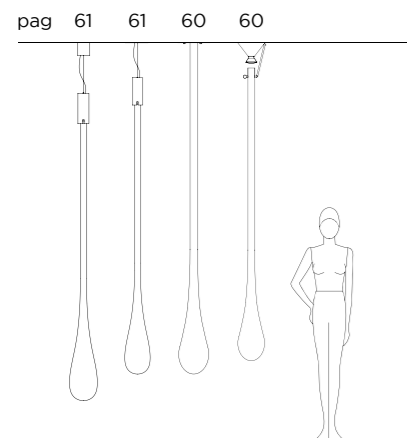

GOLF

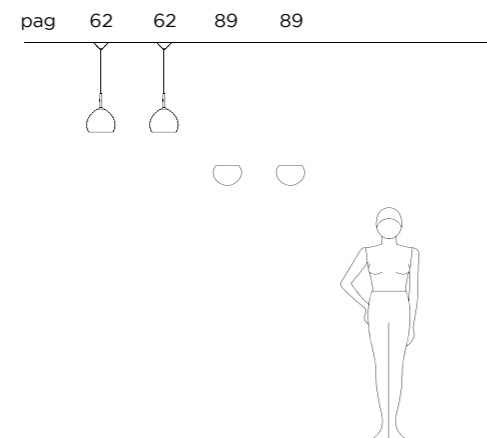

FLECHA

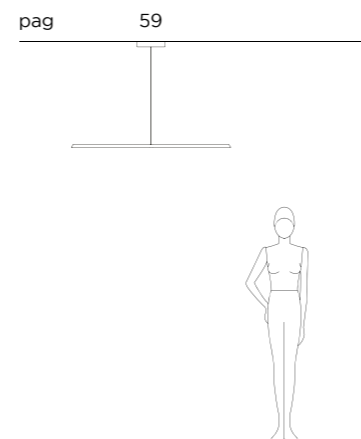

IXI

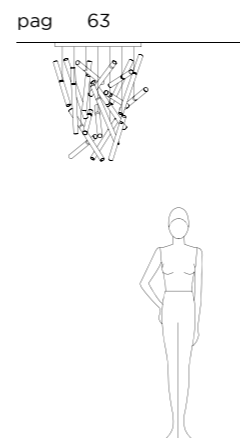

JJ

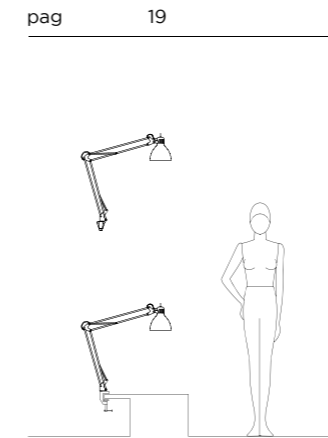

JJ - THE GREAT JJ

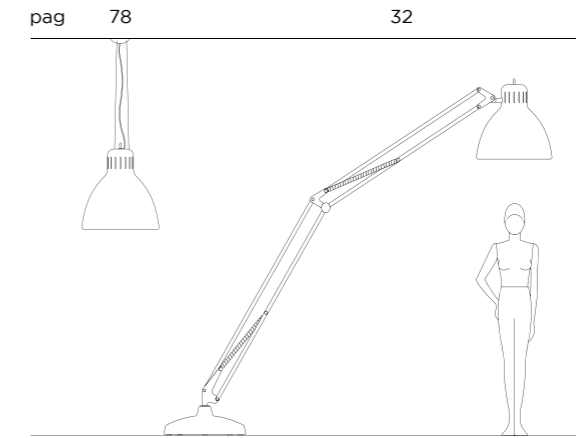

KATANA

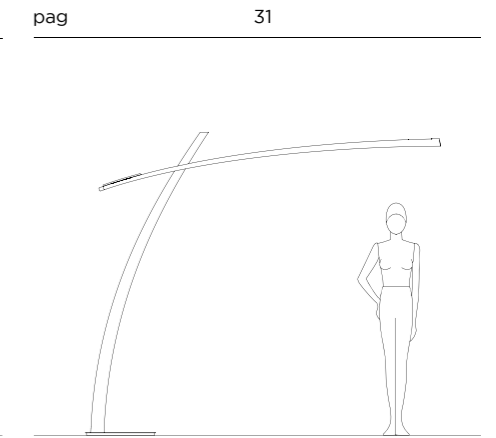

KEYRA

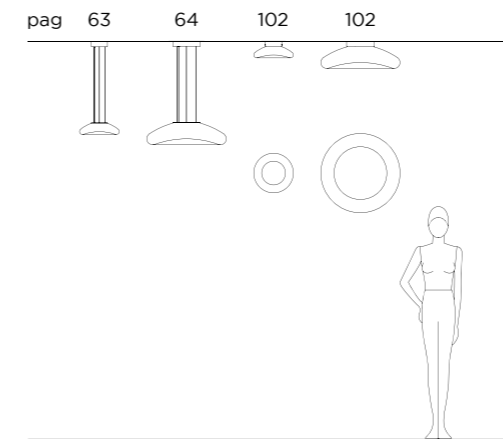

KUK

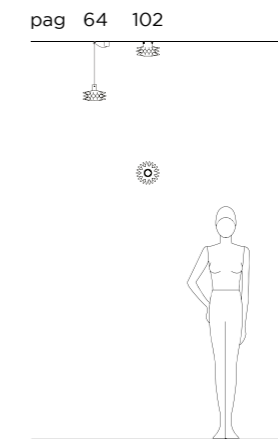

LEVA

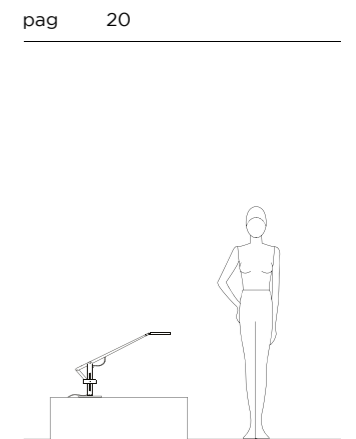

LILITH

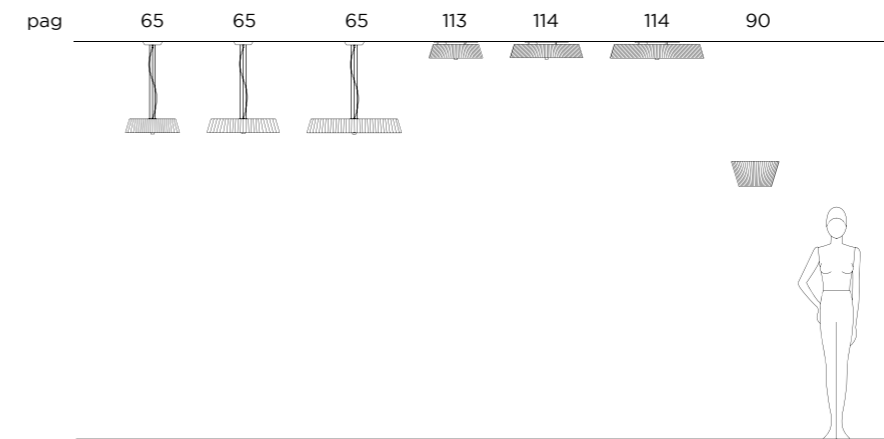

LINK

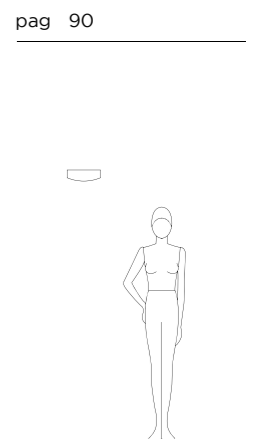

LOOP-LINE

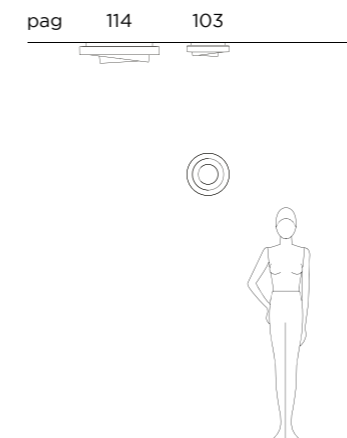

MERCURE

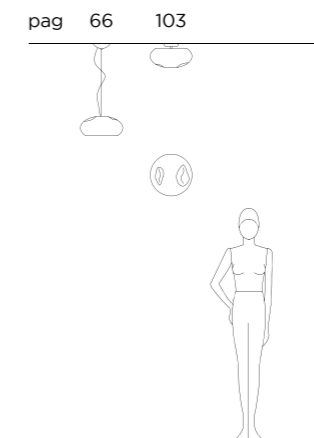

MICENE

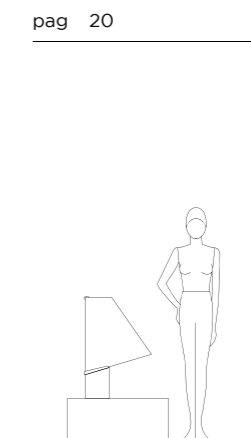

MILD

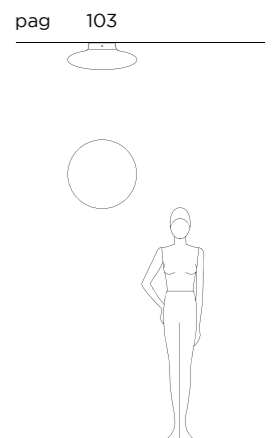

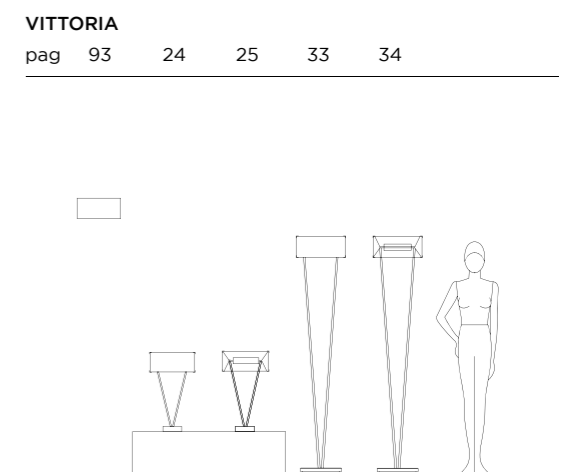
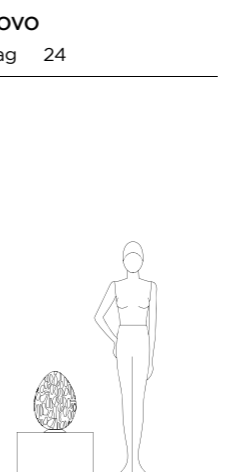
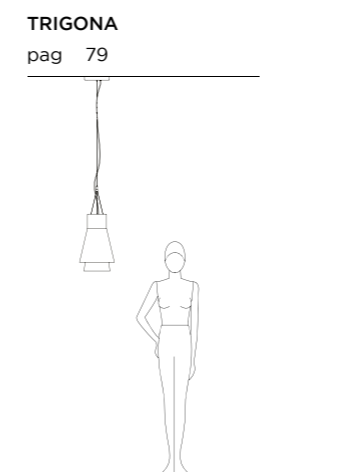
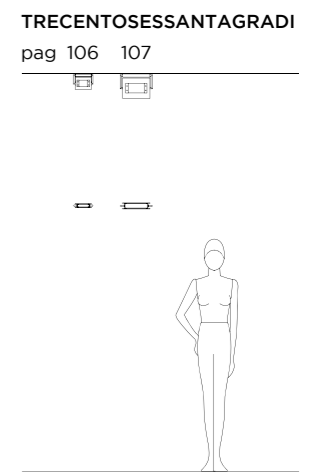
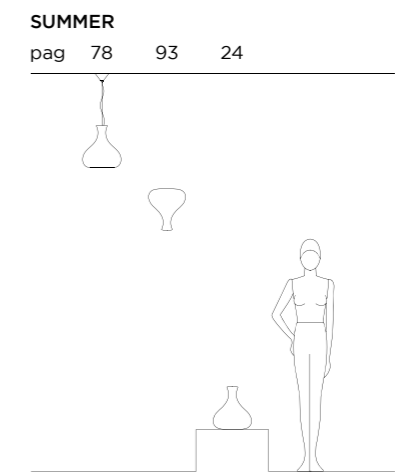
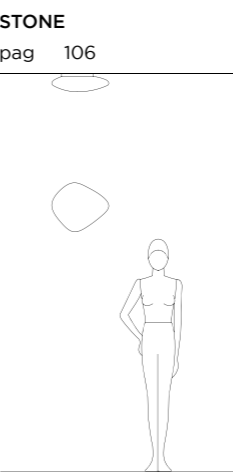
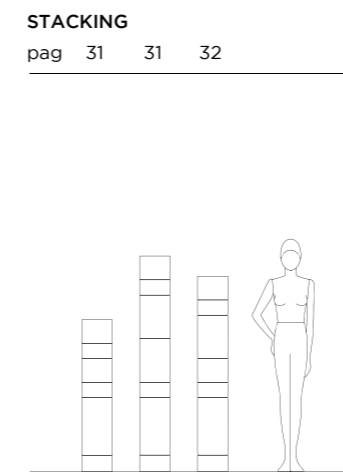
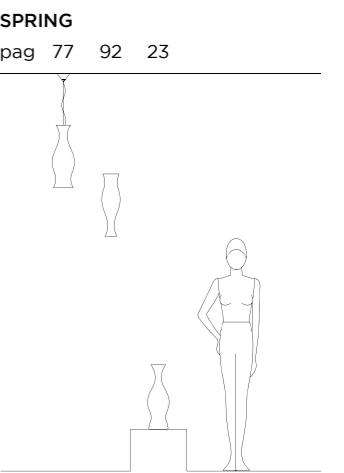
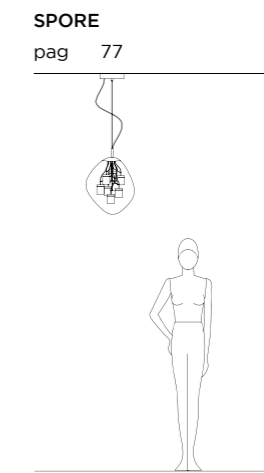
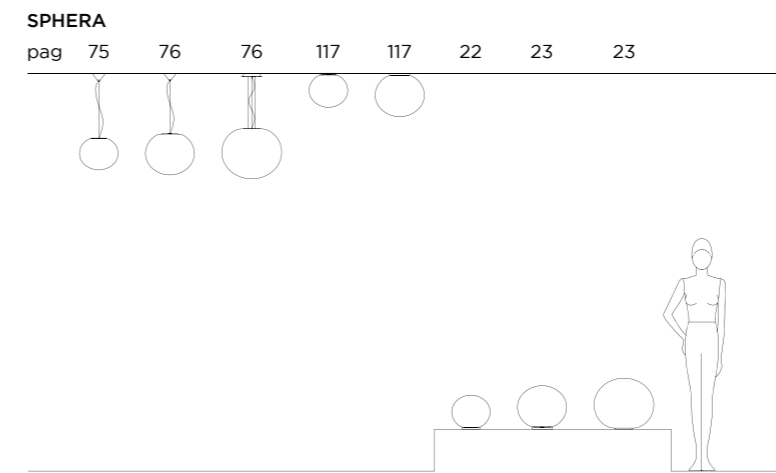
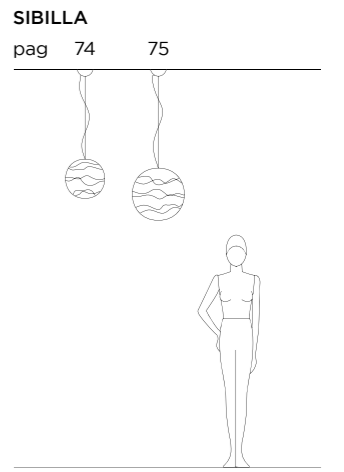
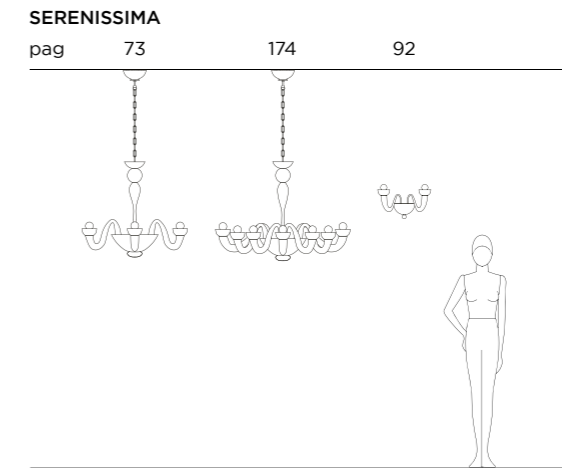
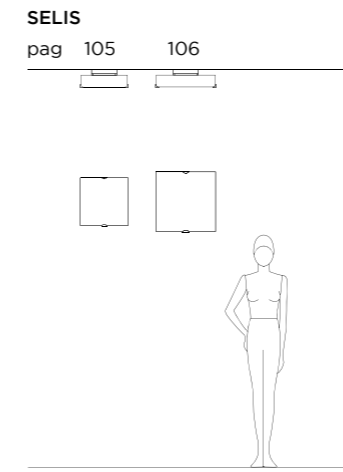
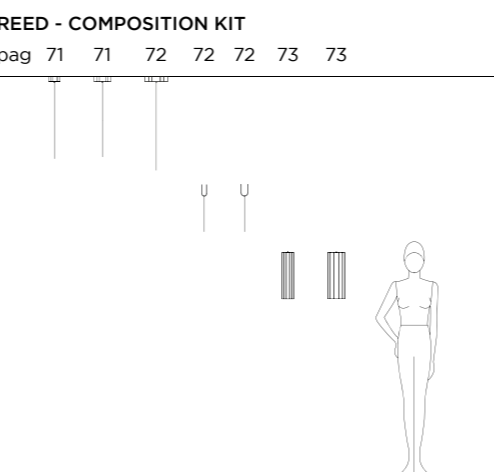
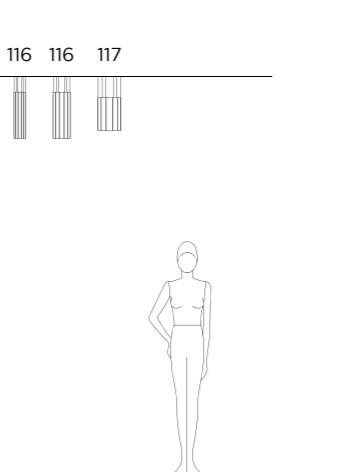
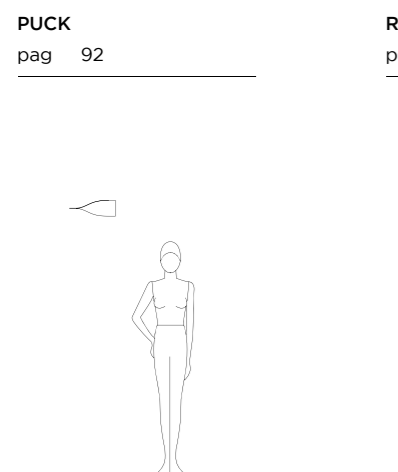
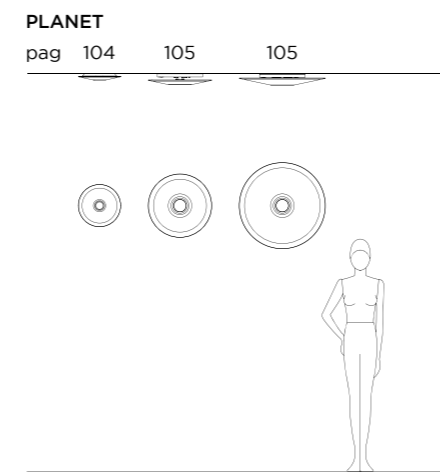
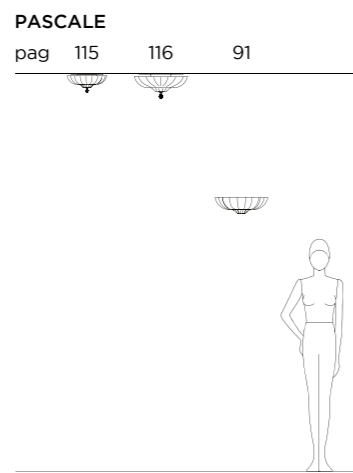
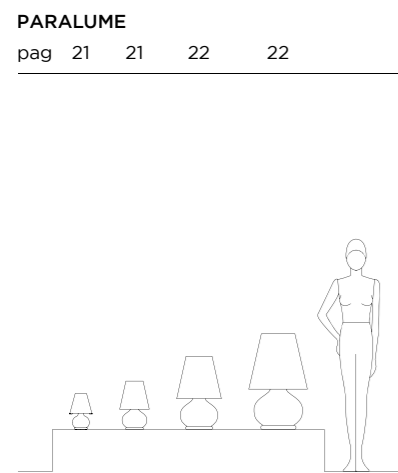
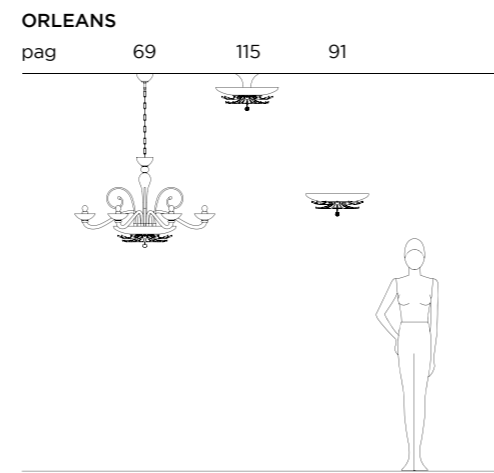
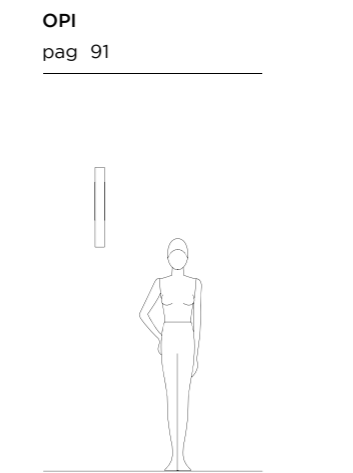
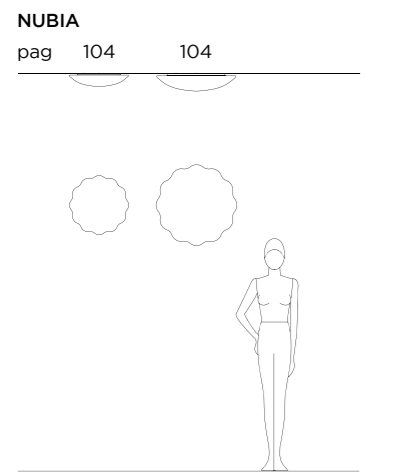
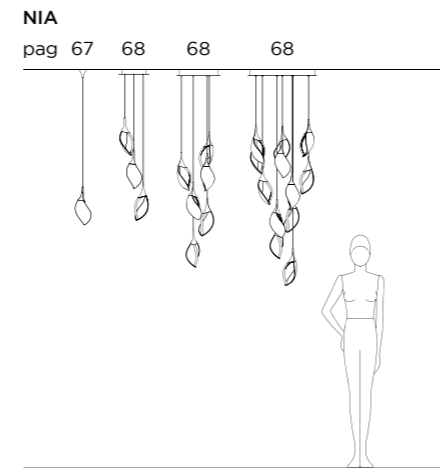
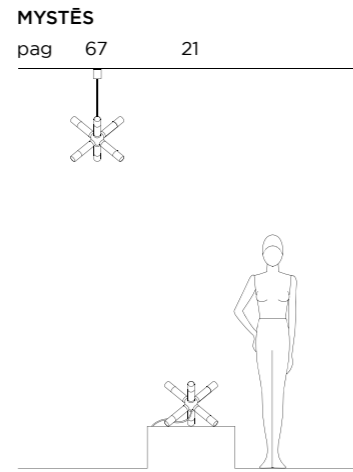
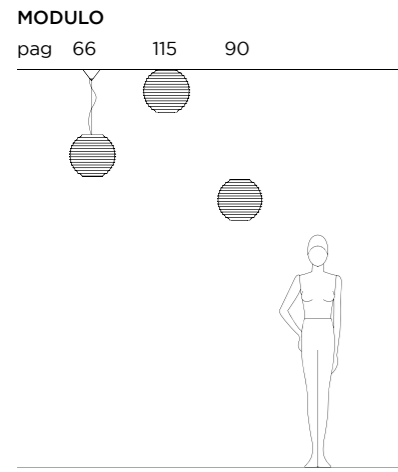

VOLTA

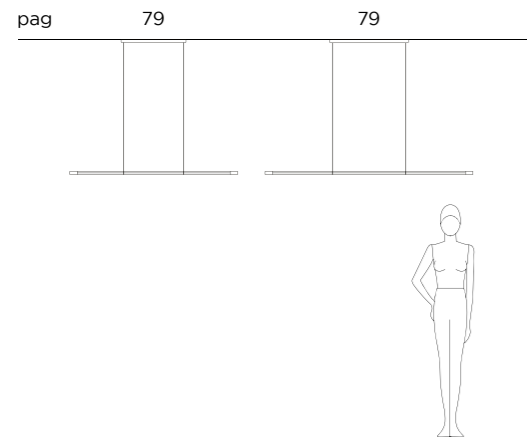

WIMPY

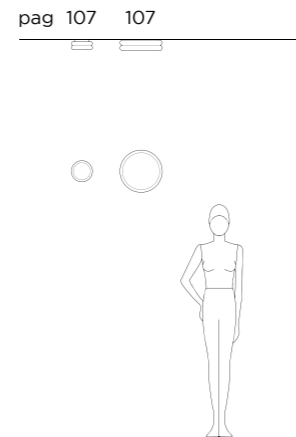

WITCH

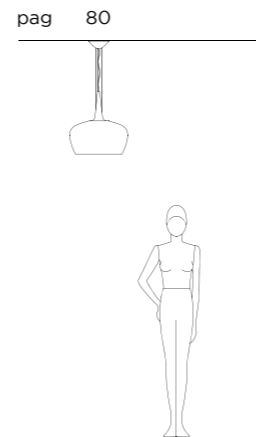

649

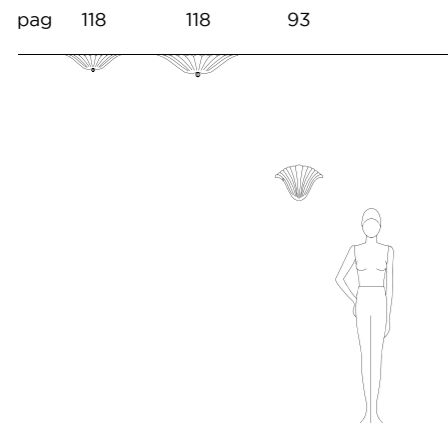

3517

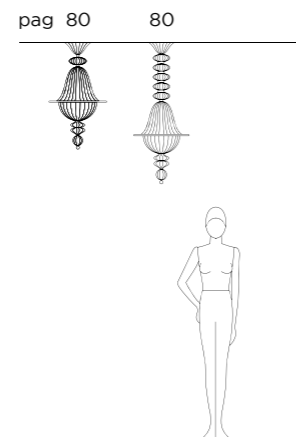

**GLASS DOWNLIGHTS
FARETTI IN VETRO**

BAIA I	pag 122
DAY I	pag 123
DIAMANTE I	pag 123
DISK I	pag 124
DROP I	pag 124
HELIOS I	pag 125
IGEA 2 I	pag 125
ISIDE 2 I	pag 126
MIRA 2 I	pag 126
ONY I	pag 127
PEGASO I	pag 127
POLAR I	pag 128
QUASAR I	pag 128
SIDERAL I	pag 129
SITH I	pag 129

SPIRA I	pag 130
STAR I	pag 131
STEP I	pag 131
SUN I	pag 132
VAN 2 I	pag 132

**ALUMINIUM DOWNLIGHTS
FARETTI IN ALLUMINIO**

SD 802 I	pag 133
SD 803 I	pag 133
SD 902 I	pag 133
SD 903 I	pag 134

**PLASTER DOWNLIGHTS
FARETTI IN GESSO**

SD 081 N I	pag 134
SD 081V N I	pag 134
SD 084 N I	pag 135
SD 085 I	pag 135
SD 086 I	pag 135
SD 087 I	pag 136
SD 087V I	pag 136

TABLE
TAVOLO



AELLA
pag. 14
ICON



AYERS
pag. 16
DESIGN



CHEOPE
pag. 17
TRADITIONAL



CLOCHE
pag. 17
DESIGN



CUBI ZERO
pag. 18
DESIGN



FAIRY
pag. 18
DESIGN



JJ
pag. 19
DESIGN



LEVA
pag. 20
DESIGN



MICENE
pag. 20
ICON



MYSTÈS
pag. 21
DESIGN



PARALUME
pag. 21
DESIGN



SPHERA
pag. 22
DESIGN



SPRING
pag. 23
DESIGN



SUMMER
pag. 24
DESIGN



UOVO
pag. 24
DESIGN



VITTORIA
pag. 24
ICON

AELLA T

Toso & Massari, 1968

ICON

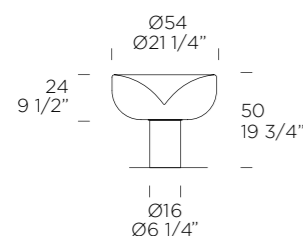
**weight-volume** 20,6 kg - 0.340 m³

EBC CE IP40

source E27 1x10W Retrofit LED (included) A+ / E**materials** blown glass, metal/*vetro soffiato, metallo*

structure finish	diffuser finish	code	price VAT excluded
gunmetal/ <i>canna di fucile</i>	smoke grey/ <i>fumé</i>	0011025	1.690,00 €
chrome/ <i>cromo lucido</i>	transparent/ <i>trasparente</i>	0004018	1.590,00 €
gold/ <i>dorato lucido</i>	transparent/ <i>trasparente</i>	0011024	1.590,00 €

notes

Maximum supported power/*Potenza massima installabile*: E27 1xMAX 150W Halo (not included)
 Bulb 1x10W E27 (LED RGB + warm white) + remote control included/
Lampadina 1x10W E27 (LED RGB + warm white) + telecomando inclusi

weight-volume 20,6 kg - 0.340 m³

EBC CE IP40

source 1x17W LED 2300lm 3000K CRI 80 (included) A+ / A LED**materials** blown glass, metal/*vetro soffiato, metallo*

structure finish	diffuser finish	code	price VAT excluded
gunmetal/ <i>canna di fucile</i>	smoke grey/ <i>fumé</i>	0008697	2.090,00 €
chrome/ <i>cromo lucido</i>	transparent/ <i>trasparente</i>	0004019	1.990,00 €
gold/ <i>dorato lucido</i>	transparent/ <i>trasparente</i>	0009244	1.990,00 €

notesWith dimmer/*Con dimmer***weight-volume** 25 kg - 0.340 m³

EBC CE IP40

source 1x17W LED 2300lm 3000K CRI 80 (included) A+ LED**materials** blown glass, marble/*vetro soffiato, marmo*

structure finish	diffuser finish	code	price VAT excluded
white onyx/ <i>onice bianco</i>	transparent/ <i>trasparente</i>	0009238	4.090,00 €

notesWith dimmer/*Con dimmer***AELLA MINI T 30**

Toso & Massari, 2017

ICON

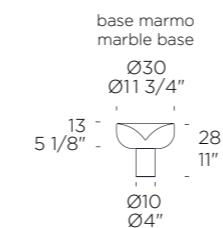
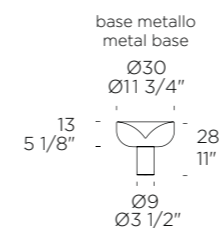
**weight-volume** 6,1 kg - 0.060 m³

CE IP40

source 1x8W LED 650lm 2700K CRI>90 (included) A++ / A LED**materials** blown glass, metal/*vetro soffiato, metallo*

structure finish	diffuser finish	code	price VAT excluded
gunmetal/ <i>canna di fucile</i>	smoke grey/ <i>fumé</i>	0008913	520,00 €
chrome/ <i>cromo lucido</i>	transparent/ <i>trasparente</i>	0008713	490,00 €
gold/ <i>dorato lucido</i>	transparent/ <i>trasparente</i>	0008731	490,00 €

notesWith dimmer/*Con dimmer***weight-volume** 6,6 kg - 0.060 m³

CE IP40

source 1x8W LED 650lm 2700K CRI>90 (included) A++ / A LED**materials** blown glass, marble/*vetro soffiato, marmo*

structure finish	diffuser finish	code	price VAT excluded
white onyx/ <i>onice bianco</i>	transparent/ <i>trasparente</i>	0008790	1.040,00 €

notesWith dimmer/*Con dimmer***AELLA BOLD T**

Toso & Massari, 2017

ICON

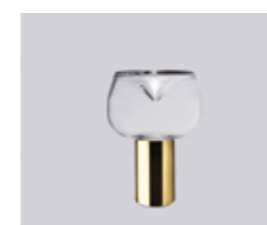
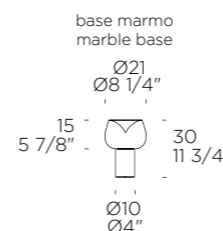
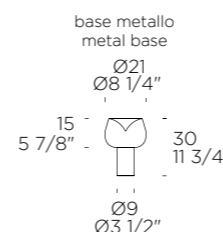
**weight-volume** 5 kg - 0.060 m³

CE IP40

source 1x8W LED 650lm 2700K CRI>90 (included) A++ / A LED**materials** blown glass, metal/*vetro soffiato, metallo*

structure finish	diffuser finish	code	price VAT excluded
gunmetal/ <i>canna di fucile</i>	smoke grey/ <i>fumé</i>	0008896	480,00 €
chrome/ <i>cromo lucido</i>	transparent/ <i>trasparente</i>	0008801	450,00 €
gold/ <i>dorato lucido</i>	transparent/ <i>trasparente</i>	0008807	450,00 €

notesWith dimmer/*Con dimmer***weight-volume** 5,6 kg - 0.060 m³

CE IP40

source 1x8W LED 650lm 2700K CRI>90 (included) A++ / A LED**materials** blown glass, marble/*vetro soffiato, marmo*

structure finish	diffuser finish	code	price VAT excluded
white onyx/ <i>onice bianco</i>	transparent/ <i>trasparente</i>	0008805	980,00 €

notesWith dimmer/*Con dimmer*

AELLA THIN T

Toso & Massari, 2017

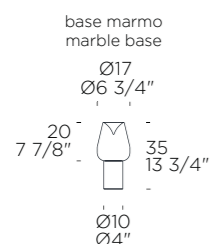
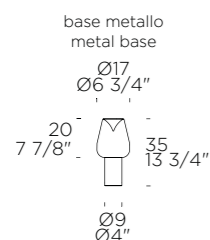
ICON**weight-volume** 5 kg - 0.060 m³**source** 1x8W LED 650lm 2700K CRI>90 (included) A++ / A **LED****materials** blown glass, metal/*vetro soffiato, metallo*

structure finish	diffuser finish	code	price VAT excluded
gunmetal/ <i>canna di fucile</i>	smoke grey/ <i>fumé</i>	0008919	480,00 €
chrome/ <i>cromo lucido</i>	transparent/ <i>trasparente</i>	0008813	450,00 €
gold/ <i>dorato lucido</i>	transparent/ <i>trasparente</i>	0008819	450,00 €

notesWith dimmer/*con dimmer***weight-volume** 5,2 kg - 0.060 m³**source** 1x8W LED 650lm 2700K CRI>90 (included) A++ / A **LED****materials** blown glass, marble/*vetro soffiato, marmo*

structure finish	diffuser finish	code	price VAT excluded
white onyx/ <i>onice bianco</i>	transparent/ <i>trasparente</i>	0008817	980,00 €

notesWith dimmer/*con dimmer***AYERS T 19**

Marco Piva, 2005

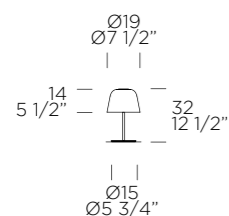
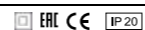
DESIGN**weight-volume** 4,3 kg - 0.040 m³**source** E14 1x5W Retrofit LED (not included) A+ / E**materials** blown glass, metal/*vetro soffiato, metallo*

structure finish	diffuser finish	code	price VAT excluded
white/ <i>bianco</i>	gloss white/ <i>bianco lucido</i>	0004068	253,00 €

notesMaximum supported power/*Potenza massima installabile*: E14 1xMAX 46W Halo (not included)**AYERS T 38**

Marco Piva, 2005

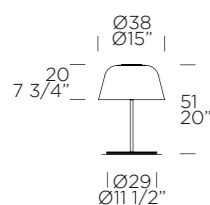
DESIGN**weight-volume** 8,1 kg - 0.220 m³**source** E27 1x10W Retrofit LED (not included) A+ / E**materials** blown glass, metal/*vetro soffiato, metallo*

structure finish	diffuser finish	code	price VAT excluded
white/ <i>bianco</i>	gloss white/ <i>bianco lucido</i>	0004021	524,00 €

notesWith dimmer/*con dimmer*Maximum supported power/*Potenza massima installabile*: E27 1xMAX 150W Halo (not included)**CHEOPE T 32**

Leucos Design Lab, 2003

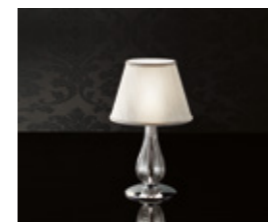
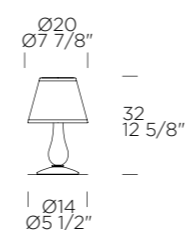
TRADITIONAL**weight-volume** 1,7 kg - 0.030 m³**source** E14 1x5W Retrofit LED (not included) A+ / E**materials** Moire fabric, handmade glass and metal/*tessuto Moire, vetro lavorato a mano e metallo*

structure finish	diffuser finish	code	price VAT excluded
chrome-transparent/ <i>cromo lucido-trasparente</i>	white/ <i>bianco</i>	0009802	303,00 €
gold-amber/ <i>dorato lucido-ambra</i>	white/ <i>bianco</i>	0009800	335,00 €

notesWith dimmer/*Con dimmer*Lampshade in Moire fabric included/*Paralume in tessuto Moire incluso*Maximum supported power/*Potenza massima installabile*: E14 1xMAX 46W Halo (not included)**CHEOPE T 42**

Leucos Design Lab, 2003

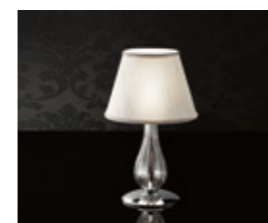
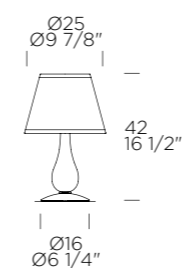
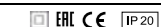
TRADITIONAL**weight-volume** 1,9 kg - 0.030 m³**source** E27 1x10W Retrofit LED (not included) A+ / E**materials** Moire fabric, handmade glass and metal/*tessuto Moire, vetro lavorato a mano e metallo*

structure finish	diffuser finish	code	price VAT excluded
chrome/transparent/ <i>cromo-trasparente</i>	white/ <i>bianco</i>	0009798	319,00 €
gold/amber/ <i>dorato lucido/ambra</i>	white/ <i>bianco</i>	0009804	360,00 €

notesWith dimmer/*Con dimmer*Lampshade in Moire fabric included/*Paralume in tessuto Moire incluso*Maximum supported power/*Potenza massima installabile*: E27 1xMAX 57W Halo (not included)**CLOCHE T**

Danilo De Rossi, 2013

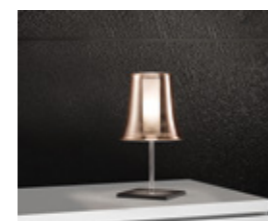
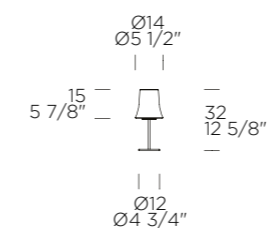
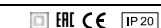
DESIGN**weight-volume** 2,2 kg - 0.020 m³**source** G9 1x3W Retrofit LED (not included) A+ / D**materials** borosilicate glass, metal/*vetro borosilicato, metallo*

structure finish	diffuser finish	code	price VAT excluded
chrome/ <i>cromo lucido</i>	chromed/ <i>cromatizzato</i>	0004056	589,00 €
copper/ <i>ramato</i>	copper/ <i>ramato</i>	0004058	639,00 €

notesWith push dimmer/*Con push dimmer*Maximum supported power/*Potenza massima installabile*: G9 1xMAX 33W Halo (not included)

CUBI ZERO T 11

Leucos Design Lab, 2000

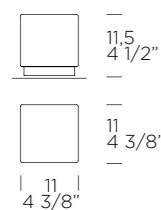
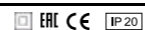
DESIGNweight-volume 1 kg - 0.020 m³

source G9 1x3W Retrofit LED (not included) A+ / D

materials blown and layered glass, polycarbonate/*vetro soffiato e incamiciato, policarbonato*

structure finish	diffuser finish	code	price VAT excluded
grey/ <i>grigio</i>	satin white/ <i>bianco satinato</i>	0002029	110,00 €

notesSatin finish/*Finitura satinata*Maximum supported power/*Potenza massima installabile*: G9 1xMAX 33W Halo (included)**CUBI ZERO T 16**

Leucos Design Lab, 2000

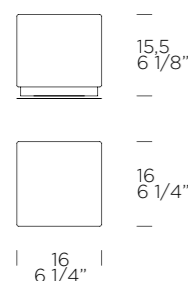
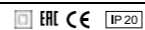
weight-volume 2 kg - 0.040 m³

source G9 1x3W Retrofit LED (not included) A+ / D

materials blown and layered glass, polycarbonate/*vetro soffiato e incamiciato, policarbonato*

structure finish	diffuser finish	code	price VAT excluded
grey/ <i>grigio</i>	satin white/ <i>bianco satinato</i>	0002019	140,00 €

notesSatin finish/*Finitura satinata*Maximum supported power/*Potenza massima installabile*: G9 1xMAX 48W Halo (included)**JJ T-P**

Leucos Design Lab, 1937

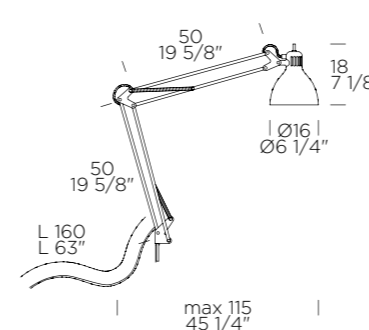
DESIGNweight-volume 2 kg - 0.030 m³

source E27 1x10W Retrofit LED (not included) A+ / E

materials aluminium/*alluminio*

structure finish	diffuser finish	code	price VAT excluded
gloss white/ <i>bianco lucido</i>	gloss white/ <i>bianco lucido</i>	0011020	185,00 €
matte white/ <i>bianco opaco</i>	matte white/ <i>bianco opaco</i>	0011021	185,00 €
gloss black/ <i>nero lucido</i>	gloss black/ <i>nero lucido</i>	0011022	185,00 €
matte black/ <i>nero opaco</i>	matte black/ <i>nero opaco</i>	0011023	185,00 €

accessories

table bracket/ <i>attacco tavolo</i> A-AX gloss white/ <i>bianco lucido</i>	8000300	21,00 €
table bracket/ <i>attacco tavolo</i> A-AX matt white/ <i>bianco opaco</i>	8000301	21,00 €
table bracket/ <i>attacco tavolo</i> A-AX gloss black/ <i>nero lucido</i>	8000302	21,00 €
table bracket/ <i>attacco tavolo</i> A-AX matt black/ <i>nero opaco</i>	8000303	21,00 €

table bracket/ <i>attacco tavolo</i> A LUNGO matt white/ <i>bianco opaco</i>	8000088	21,00 €
table bracket/ <i>attacco tavolo</i> A LUNGO matt black/ <i>nero opaco</i>	8000090	21,00 €

wall bracket/ <i>attacco parete</i> B LARGE gloss black/ <i>nero lucido</i>	8000267	21,00 €
wall bracket/ <i>attacco parete</i> B LARGE matt black/ <i>nero opaco</i>	8000094	21,00 €
wall bracket/ <i>attacco parete</i> B LARGE gloss white/ <i>bianco lucido</i>	8000266	21,00 €
wall bracket/ <i>attacco parete</i> B LARGE matt white/ <i>bianco opaco</i>	8000092	21,00 €

bracket/ <i>attacco tavolo</i> C matt white/ <i>bianco opaco</i>	8000095	21,00 €
bracket/ <i>attacco tavolo</i> C matt black/ <i>nero opaco</i>	8000097	21,00 €

bracket/ <i>attacco tavolo</i> P black/ <i>nero</i>	8000098	7,00 €
---	---------	--------

round base JJ T-P glossy black/ <i>nero lucido</i>	8000082	79,00 €
round base JJ T-P matt black/ <i>nero opaco</i>	8000080	79,00 €
round base JJ T-P matt white/ <i>bianco opaco</i>	8000078	79,00 €
round base JJ T-P gloss white/ <i>bianco lucido</i>	8000081	79,00 €

**notes**Special versions available upon request/*A richiesta versioni colore speciali*Dimmable with external button (external button not supplied)/*Dimmerabile con pulsante esterno (pulsante esterno non fornito)*Maximum supported power/*Potenza massima installabile*: E27 1xMAX 46W Halo (not included)table bracket/*attacco tavolo* A-AX (H max 5,5 cm - 2 1/8")table bracket/*attacco tavolo* A LUNGO (H max 9,5 cm - 3 3/4")**FAIRY T C**

Toso, Massari & Associates With G. Toso, 2017

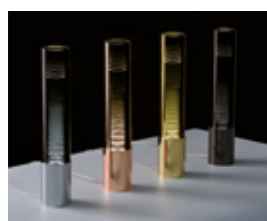
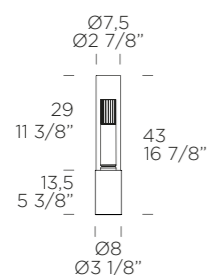
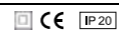
DESIGNweight-volume 3,1 kg - 0.020 m³source 1x8W LED 650lm 2700K CRI>90 (included) A++ **LED**materials borosilicate glass, metal/*vetro borosilicato, metallo*

structure finish	diffuser finish	code	price VAT excluded
gunmetal/ <i>canna di fucile</i>	gunmetal sfumato/ <i>canna di fucile sfumato</i>	0008708	470,00 €
chrome/ <i>cromo lucido</i>	transparent/ <i>trasparente</i>	0008707	390,00 €
chrome/ <i>cromo lucido</i>	chrome sfumato/ <i>cromato sfumato</i>	0008720	470,00 €
gold/ <i>dorato lucido</i>	gold sfumato/ <i>oro sfumato</i>	0008719	470,00 €
rose gold/ <i>oro rosa lucido</i>	rose gold sfumato/ <i>oro rosa sfumato</i>	0008718	470,00 €

notesWith push dimmer/*Con push dimmer*

LEVA T - LEVA EVO T

Massimo Iosa Ghini, 2012-2017

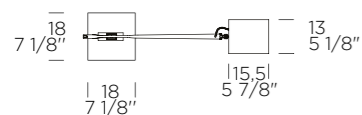
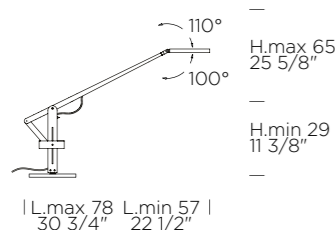
DESIGN

weight-volume	3 kg - 0.040 m ³	LEVA T		
source	1x8W LED 650lm 3000K CRI 90 (inclusa) A++	LED		
materials	beech wood, metal/legno faggio, metallo			
structure finish	diffuser finish	code	price VAT excluded	
natural steel finish/ acciaio con finitura naturale	natural beech wood/ faggio naturale	0002016	499,00 €	
notes	Metal base included/Base in metallo inclusa 2 step dimmer			

weight-volume	3 kg - 0.040 m ³	LEVA EVO T		
source	1x10,5W LED 800lm 3000K CRI 90 (inclusa) A++	LED		
materials	beech wood, metal/legno faggio, metallo			
structure finish	diffuser finish	code	price VAT excluded	
aluminium grey/ grigio alluminio	bleached beech/ faggio sbiancato	0009828	599,00 €	
notes	Metal base included/Base in metallo inclusa Touch dimmer 5-100%			

MYSTÈS T

Roberto Paoli, 2018

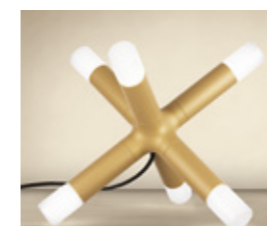
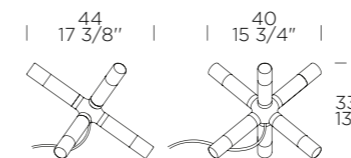
DESIGN

weight-volume	6,5 kg - 0.220 m ³		
source	E14 6x5W Retrofit LED (not included) A+ / B		
materials	metal, borosilicate glass/metallo, vetro borosilicato		
structure finish	diffuser finish	code	price VAT excluded
anthracite with black cable/ antracite con cavo nero	sandblasted borosilicate/ borosilicato sabbato	0010300	1.024,00 €
white RAL 9010 with red cable/bianco RAL 9010 con cavo rosso	sandblasted borosilicate/ borosilicato sabbato	0010304	999,00 €
"cappadocia" gold with black cable/oro cappadocia con cavo nero	sandblasted borosilicate/ borosilicato sabbato	0010306	1.024,00 €

notes
Textile cable/Cavo in tessuto
Clear glass available on request/Colori personalizzati su richiesta
Custom colors on request/Colori speciali su richiesta
Maximum supported power/Potenza massima installabile: E14 6xMAX 8W Retrofit LED (not included)
With dimmer/Con dimmer

PARALUME MINI T

Leucos Design Lab, 2004

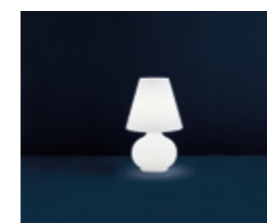
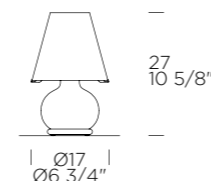
DESIGN

weight-volume	1,8 kg - 0.040 m ³			
source	E14 1x5W Retrofit LED (not included) A+ / E + G9 1x3W Retrofit LED (not included)			
materials	blown and layered glass, metal/vetro soffiato e incamiciato, metallo			
structure finish	diffuser finish	code	price VAT excluded	
white/bianco	satin white/bianco satinato	0002524	352,00 €	
notes	Lamp with double light switch/Lampada con doppia accensione Maximum supported power/Potenza massima installabile: E14 1xMAX 46W Halo (not included) + G9 1xMAX 20W Halo (not included)			

MICENE T

Toso, Massari & Associates, 1991

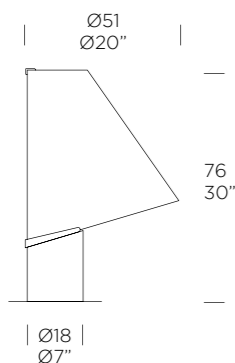
ICON

weight-volume	22,8 kg - 0.400 m ³			
source	E27 1x10W Retrofit LED (not included) A+ / E			
materials	blown glass, "Carrara" marble/vetro soffiato, marmo di "Carrara"			
structure finish	diffuser finish	code	price VAT excluded	
carrara marble-titanium/ titanio con base in marmo bianco di carrara	satin white/bianco satinato	0004038	2.123,00 €	
notes	With dimmer/Con dimmer Maximum supported power/Potenza massima installabile: E27 1xMAX 205W Halo (not included)			

PARALUME P (SMALL) T

Leucos Design Lab, 1983

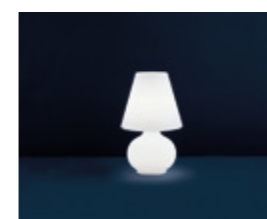
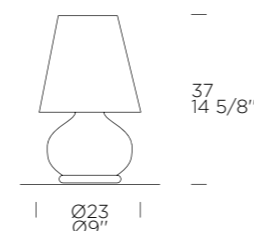
DESIGN

weight-volume	3 kg - 0.070 m ³			
source	E14 1x5W Retrofit LED (not included) A+ / E + E14 1x5W Retrofit LED (not included)			
materials	blown and layered glass, metal/vetro soffiato e incamiciato, metallo			
structure finish	diffuser finish	code	price VAT excluded	
white/bianco	satin white/bianco satinato	0002523	393,00 €	
notes	Lamp with double light switch/Lampada con doppia accensione Maximum supported power/Potenza massima installabile: E14 1xMAX 46W Halo (not included) + E14 1xMAX 30W Halo (not included)			

PARALUME M (MEDIUM) T

Leucos Design Lab, 1983

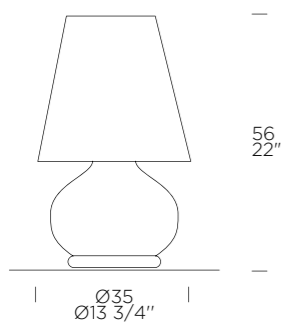
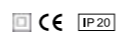
DESIGN**weight-volume** 8,7 kg - 0.130 m³**source** E27 1x10W Retrofit LED (not included) A+ / E
+ E27 1x10W Retrofit LED (not included)**materials** blown and layered glass, metal/*vetro soffiato e incamiciato, metallo*

structure finish	diffuser finish	code	price VAT excluded
white/ <i>bianco</i>	satin white/ <i>bianco satinato</i>	0002516	581,00 €

notesLamp with double light switch/*Lampada con doppia accensione*Maximum supported power/*Potenza massima installabile*: E27 1xMAX 77W Halo (not included) + E27 1xMAX 46W Halo (not included)**PARALUME G (BIG) T**

Leucos Design Lab, 1983

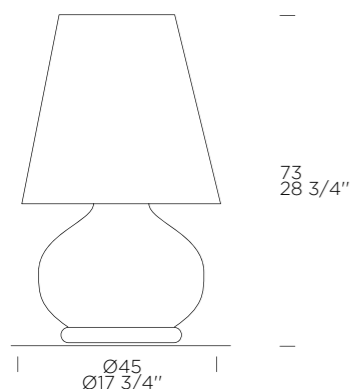
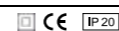
DESIGN**weight-volume** 13,4 kg - 0.250 m³**source** E27 2x10W Retrofit LED (not included) A+ / E**materials** blown and layered glass, metal/*vetro soffiato e incamiciato, metallo*

structure finish	diffuser finish	code	price VAT excluded
white/ <i>bianco</i>	satin white/ <i>bianco satinato</i>	0002514	983,00 €

notesLamp with double light switch/*Lampada con doppia accensione*Maximum supported power/*Potenza massima installabile*: E27 2xMAX 77W Halo (not included)**SPHERA T 3/29**

Matteo Thun, 2000

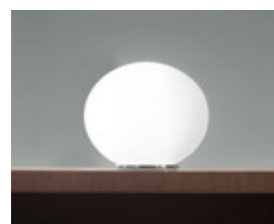
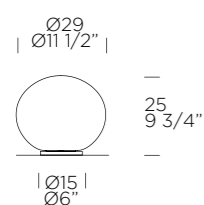
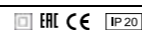
DESIGN**weight-volume** 3,9 kg - 0.080 m³**source** E27 1x15W Retrofit LED (not included) A+ / E**materials** blown glass, metal/*vetro soffiato, metallo*

structure finish	diffuser finish	code	price VAT excluded
chrome/ <i>cromo lucido</i>	satin white/ <i>bianco satinato</i>	0004078	219,00 €

notesMaximum supported power/*Potenza massima installabile*: E27 1xMAX 100W Halo (not included)**SPHERA T 3/37**

Matteo Thun, 2000

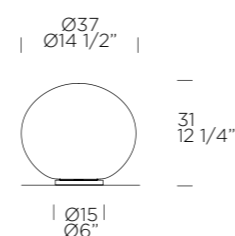
DESIGN**weight-volume** 6,1 kg - 0.150 m³**source** E27 1x15W Retrofit LED (not included) A+ / E**materials** blown glass, metal/*vetro soffiato, metallo*

structure finish	diffuser finish	code	price VAT excluded
chrome/ <i>cromo lucido</i>	satin white/ <i>bianco satinato</i>	0004081	279,00 €

notesWith dimmer/*Con dimmer*Maximum supported power/*Potenza massima installabile*: E27 1xMAX 150W Halo (not included)**SPHERA T 3/45**

Matteo Thun, 2000

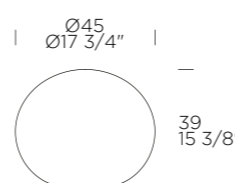
DESIGN**weight-volume** 7,4 kg - 0.130 m³**source** E27 1x15W Retrofit LED (not included) A+ / E**materials** blown glass, metal/*vetro soffiato, metallo*

structure finish	diffuser finish	code	price VAT excluded
chrome/ <i>cromo lucido</i>	satin white/ <i>bianco satinato</i>	0004062	379,00 €

notesWith dimmer/*Con dimmer*Maximum supported power/*Potenza massima installabile*: E27 1xMAX 150W Halo (not included)**SPRING T**

Eva Zeisel, 2012

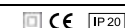
DESIGN**peso-volume** 3,5 kg - 0.060 m³**source** E27 1x10W Retrofit LED (not included) A+ / E**materials** blown glass, metal/*vetro soffiato, metallo*

structure finish	diffuser finish	code	price VAT excluded
chrome/ <i>cromo lucido</i>	gloss white/ <i>biano lucido</i>	0004294	401,00 €
chrome/ <i>cromo lucido</i>	gloss honey/ <i>giallo paglierino</i>	0004295	401,00 €

notesMaximum supported power/*Potenza massima installabile*: E27 1xMAX 57W Halo (not included)

SUMMER T

Eva Zeisel, 2012

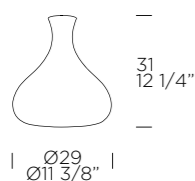
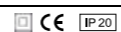
DESIGN**weight-volume** 3,7 kg - 0.070 m³**source** E27 1x10W Retrofit LED (not included) A+ / E**materials** blown glass, metal/*vetro soffiato, metallo*

structure finish	diffuser finish	code	price VAT excluded
chrome/ <i>cromo lucido</i>	gloss white/ <i>bianco lucido</i>	0004288	425,00 €
chrome/ <i>cromo lucido</i>	gloss honey/ <i>giallo paglierino</i>	0004289	425,00 €

notesMaximum supported power/*Potenza massima installabile*: E27 1xMAX 57W Halo (not included)**UOVO T 46**

Leucos Design Lab, 2000

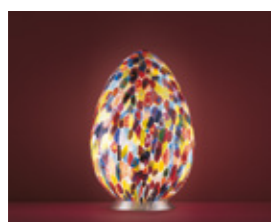
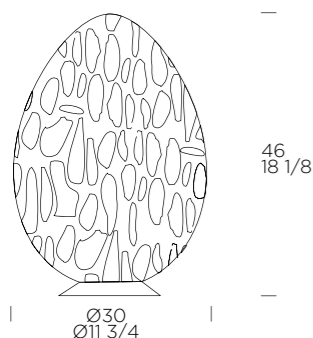
DESIGN**weight-volume** 6 kg - 0.130 m³**source** E27 1x10W Retrofit LED (not included) A+ / E**materials** handmade blown and layered glass with "murrine", metal

structure finish	diffuser finish	code	price VAT excluded
satin nickel/ <i>nicel satinato</i>	multicolored murrine/ <i>murrine multicolore</i>	0000273	876,00 €

notesMaximum supported power/*Potenza massima installabile*: E27 1xMAX 46W Halo (not included)**VITTORIA T 1**

Toso, Massari & Associates, 1992

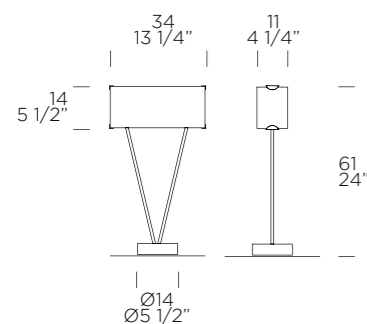
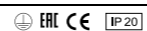
ICON**weight-volume** 9,07 kg - 0.170 m³**source** R7s 114mm 1x10W Retrofit LED (not included) A+ / D**materials** blown glass, metal/*vetro soffiato, metallo*

structure finish	diffuser finish	code	price VAT excluded
chrome/ <i>cromo lucido</i>	satin white/ <i>bianco satinato</i>	0004046	843,00 €

notesMaximum supported power/*Potenza massima installabile*: R7s 114mm 1xMAX 160W Halo (not included)
With dimmer/*Con dimmer***VITTORIA T 1/C**

Toso, Massari & Associates, 1992

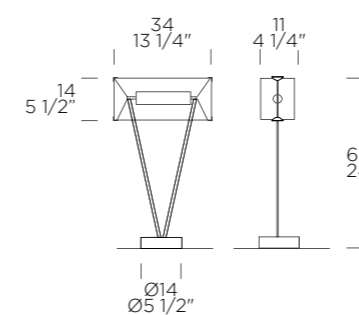
ICON**weight-volume** 8,62 kg - 0.170 m³**source** R7s 114mm 1x10W Retrofit LED (not included) A+ / D**materials** blown glass, metal/*vetro soffiato, metallo*

structure finish	diffuser finish	code	price VAT excluded
chrome/ <i>cromo lucido</i>	transparent/ <i>trasparente</i>	0004044	983,00 €

notesAnti-glare kit included/*Kit antiabbagliamento incluso*
Maximum supported power/*Potenza massima installabile*: R7s 114mm 1xMAX 160W Halo (not included)
With dimmer/*Con dimmer*



AYERS
pag. 30
DESIGN



CHEOPE
pag. 30
TRADITIONAL



KATANA
pag. 31
ICON



STACKING
pag. 31
ICON



THE GREAT JJ
pag. 32
ICON



VITTORIA TR 1
pag. 33
ICON



AYERS TR 38

Marco Piva, 2005

DESIGN

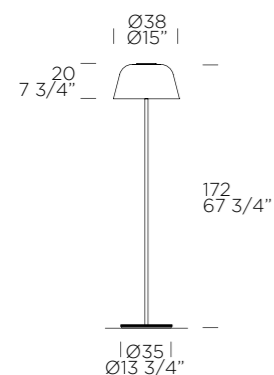

weight-volume 12,3 kg - 0.540 m³

ERIC CE IP20

source E27 1x10W Retrofit LED (not included) A+ / E

materials blown glass, metal/vetro soffiato, metallo

structure finish	diffuser finish	code	price VAT excluded
white/bianco	gloss white/bianco lucido	0004083	770,00 €

notes

With dimmer/Con dimmer

Maximum supported power/Potenza massima installabile: E27 1xMAX 205W Halo (not included)

CHEOPE TR

Leucos Design Lab, 2003

TRADITIONAL

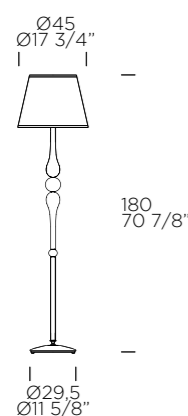

weight-volume 13,8 kg - 0.250 m³

ERIC CE IP20

source E27 1x10W Retrofit LED (not included) A+ / E

materials Moire fabric, handmade glass and metal/tessuto Moire, vetro lavorato a mano e metallo

structure finish	diffuser finish	code	price VAT excluded
chrome-transparent/ cromo lucido-trasparente	white/bianco	0009808	958,00 €
gold-amber/ dorato lucido-ambra	white/bianco	0009806	1.065,00 €

notes

With dimmer/Con dimmer

Lampshade in Moire fabric included/Paralume in tessuto Moire incluso

Maximum supported power/Potenza massima installabile: E27 1xMAX 116W Halo (not included)

KATANA TR

Valerio Cometti & Paolo Balzanelli, 2008

ICON

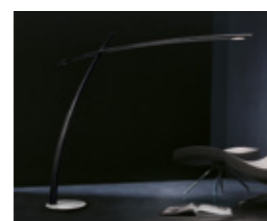
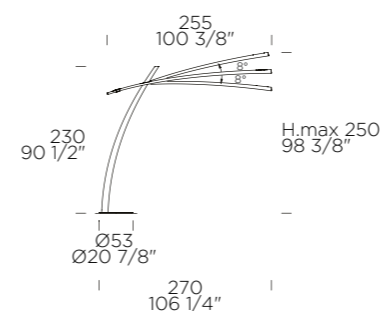

weight-volume 120 kg - 0.670 m³

CE IP20

source 1x24W LED 2800lm 2700-4000K CRI>90 (included) A++ / A LED

materials carbon fiber, steel/fibra di carbonio, acciaio

structure finish	diffuser finish	code	price VAT excluded
brushed nickel/ nichel spazzolato	natural carbon fiber/ fibra di carbonio naturale	0002071	6.959,00 €

notes

With dimmer - CASAMBI® technology/Dimmer di serie - tecnologia CASAMBI®

With electronic ballast/Completa di alimentatore elettronico

Tunable white/Bianco Dinamico

Bluetooth 4.0/Bluetooth 4.0

All the functions of the luminaire (on/off/dimming) can be managed also through a free smartphone app/ Tutte le funzionalità (accensione/spengimento/dimmerazione) sono gestite anche tramite apposita app gratuita

STACKING B TR

Rockwell Group, 2007

ICON

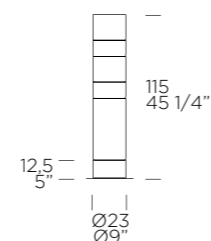

weight-volume 29,1 kg - 0.400 m³

CE IP20

source GU10 4x7W Retrofit LED (not included) A+ / B

materials blown glass, metal/vetro soffiato, metallo

structure finish	diffuser finish	code	price VAT excluded
chrome/cromo lucido	smoke grey, white, smoke grey, white, mirror/ grigio fumé, bianco, grigio fumé, bianco, specchio	0004096	2.533,00 €

notes

With dimmer/Con dimmer

Maximum supported power/Potenza massima installabile: GU10 4xMAX 50W Halo (not included)

STACKING C TR

Rockwell Group, 2007

ICON

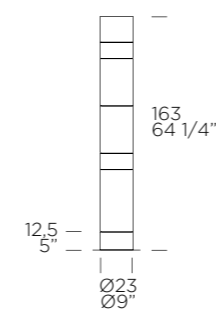

weight-volume 33,3 kg - 0.520 m³

ERIC CE IP20

source GU10 4x7W Retrofit LED (not included) A+ / B

materials blown glass, metal/vetro soffiato, metallo

structure finish	diffuser finish	code	price VAT excluded
gold/dorato lucido	smoke grey, white, amber, tobacco, white, amber/ grigio fumé, bianco, ambra, tabacco trasparente, bianco, ambra	0004098	2.861,00 €

notes

With dimmer/Con dimmer

Maximum supported power/Potenza massima installabile: GU10 4xMAX 50W Halo (not included)

STACKING D TR

Rockwell Group, 2007

ICON

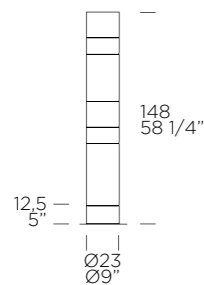

weight-volume 31,9 kg - 0.500 m³

ERL CE IP20

source GU10 4x7W Retrofit LED (not included) A+ / B

materials blown glass, metal/vetro soffiato, metallo

structure finish	diffuser finish	code	price VAT excluded
gold/dorato lucido	white, gold, transparent smoke, white, gold, black/ bianco, oro specchiato, tabacco trasparente, bianco, oro specchiato, nero	0004100	3.271,00 €

notes

With dimmer/Con dimmer

Maximum supported power/Potenza massima installabile: GU10 4xMAX 50W Halo (not included)

THE GREAT JJ TR OUTDOOR

Leucos Design Lab, 2005

ICON

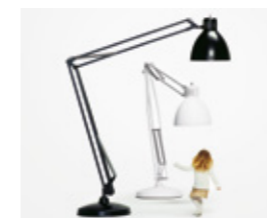
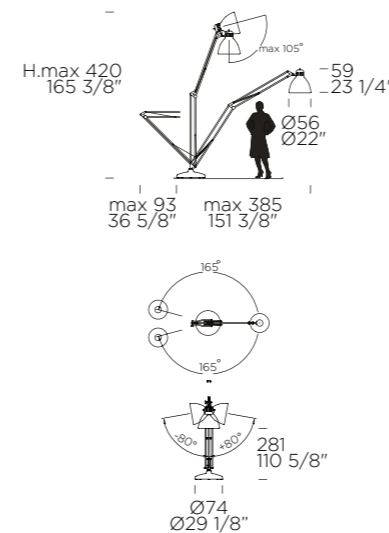

weight-volume 167 kg - 2.210 m³

ERL CE IP20

sorgente G8,5 1x max 70W (non inclusa) A+

materialis aluminum/alluminio

structure finish	diffuser finish	code	price VAT excluded
matte white/bianco opaco	matte white/bianco opaco	0002053	6.525,00 €
matte black/nero opaco	matte black/nero opaco	0002057	6.525,00 €

notes

With electronic ballast/Completa di alimentatore elettronico

Available in any sample colour even for one piece + 750,00 € (VAT excluded)/

Realizzabile in qualunque colore a campione anche per un singolo pezzo: + 750,00 € (IVA esclusa)

THE GREAT JJ TR

Leucos Design Lab, 2005

ICON

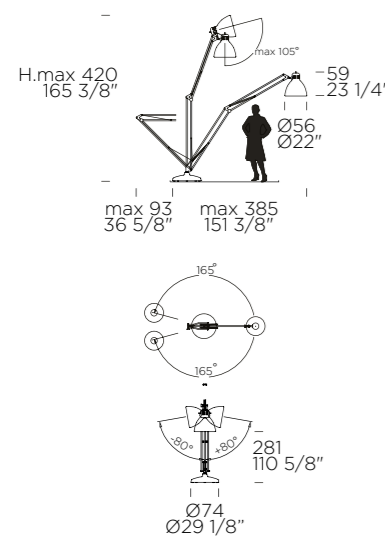

weight-volume 135,7 kg - 2.210 m³

ERL CE IP20

source E27 1x15W Retrofit LED (not included) A+ / E

materials aluminum/alluminio

structure finish	diffuser finish	code	price VAT excluded
matte white/bianco opaco	matte white/bianco opaco	0002043	5.975,00 €
gloss white/bianco lucido	gloss white/bianco lucido	0002049	5.975,00 €
matte black/nero opaco	matte black/nero opaco	0002047	5.975,00 €
gloss black/nero lucido	gloss black/nero lucido	0002051	5.975,00 €

notes

With dimmer/Con dimmer

Available in any sample colour even for one piece + 750,00 € (VAT excluded)/

Realizzabile in qualunque colore a campione anche per un singolo pezzo: + 750,00 € (IVA esclusa)

Maximum supported power/Potenza massima installabile: E27 1xMAX 205W Halo (not included)

VITTORIA TR 1

Toso, Massari & Associates, 1992

ICON

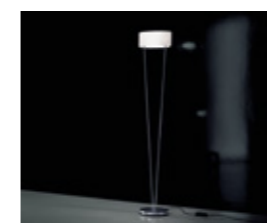
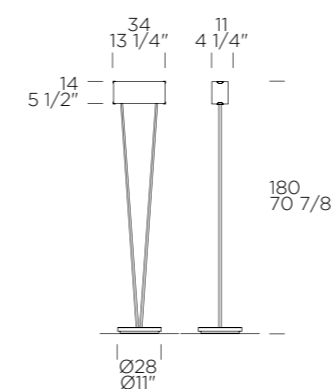

weight-volume 8,7 kg - 0.440 m³

ERL CE IP20

source R7s 114mm 1x10W Retrofit LED (not included) A+ / D

materials blown glass, metal/vetro soffiato, metallo

structure finish	diffuser finish	code	price VAT excluded
chrome/cromo lucido	satin white/bianco satinato	0004104	1.180,00 €

notes

With dimmer/Con dimmer

Maximum supported power/Potenza massima installabile: R7s 114mm 1xMAX 160W Halo (not included)

VITTORIA TR 1/C

Toso, Massari & Associates, 1992

ICON

weight-volume 8,25 kg - 0.440 m³

ERL CE IP20

source R7s 114mm 1x10W Retrofit LED (not included) A+ / D

materials blown glass, metal/*vetro soffiato, metallo*

structure finish

diffuser finish

code

price VAT excluded

chrome/*cromo lucido*

transparent/*trasparente*

0004103

1.278,00 €

notes

With dimmer/*Con dimmer*

Maximum supported power/*Potenza massima installabile*: R7s 114mm 1xMAX 160W Halo (not included)

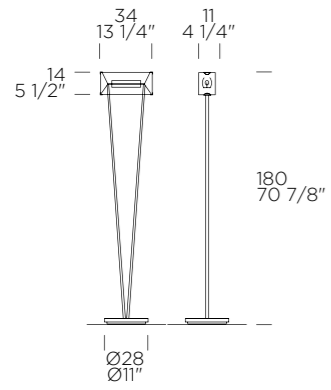

FLOOR/TERRA



PENDANT
SOSPENSIONE

PENDANT
SOSPENSIONE



AELLA
pag. 38
ICON



AKI
pag. 39
DESIGN



ALMA
pag. 39
DESIGN



ARIA
pag. 40
DESIGN



ATELIER
pag. 41
TRADITIONAL



KUK
pag. 64
DESIGN



LILITH
pag. 65
DESIGN



MERCURE
pag. 66
DESIGN



MODULO
pag. 66
DESIGN



MYSTÈS
pag. 67
DESIGN



ATHENA
pag. 42
TRADITIONAL



AXEL
pag. 42
DESIGN



AYERS
pag. 43
DESIGN



BEAMER S 11
pag. 44
DESIGN



BOHEME
pag. 46
TRADITIONAL



NIA
pag. 67
DESIGN



ORLEANS
pag. 69
TRADITIONAL



REED
pag. 70
DESIGN



SERENISSIMA
pag. 73
TRADITIONAL



SIBILLA
pag. 74
DESIGN



BOLERO
pag. 47
TRADITIONAL



CLASS
pag. 48
DESIGN



CLOCHE
pag. 49
DESIGN



CLOCHEF
pag. 50
DESIGN



CUBI
pag. 51
DESIGN



SPHERA
pag. 75
DESIGN



SPORE
pag. 77
DESIGN



SPRING
pag. 77
DESIGN



SUMMER
pag. 78
DESIGN



THE GREAT
pag. 78
DESIGN



DELUXE
pag. 52
DESIGN



ELYSEE
pag. 53
TRADITIONAL



ETHER
pag. 54
ICON



FAIRY
pag. 55
DESIGN



FELIX
pag. 58
DESIGN



TRIGONA
pag. 79
DESIGN



VOLTA
pag. 79
DESIGN



WITCH
pag. 80
DESIGN



3517
pag. 80
TRADITIONAL



FLECHA
pag. 59
DESIGN



GLÒ
pag. 60
ICON



GOLF
pag. 62
DESIGN



IXI
pag. 63
DESIGN



KEYRA
pag. 63
DESIGN

AELLA S

Toso & Massari, 2016

ICON

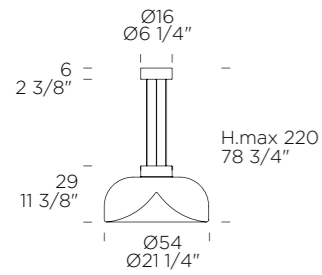

weight-volume 14,9 kg - 0.290 m³

CE IP40

source 1x26W LED 3200lm 3000K CRI 80 (included) A+ / A LED

materials blown glass, metal/vetro soffiato, metallo

structure finish	diffuser finish	code	price VAT excluded
gunmetal/canna di fucile	smoke grey/fumé	0009098	1.590,00 €
chrome/cromo lucido	transparent/trasparente	0004929	1.490,00 €
gold/dorato lucido	transparent/trasparente	0009260	1.490,00 €

note

Cable Insulation Kit included/Kit isolamento cavo incluso
 Phase cut dimming version available on request/
 Versione dimmerabile a taglio di fase disponibile su richiesta
 Dimmable/Dimmerabile: 1/10V; push-dim; dali

AELLA MINI S 30

Toso & Massari, 2017

ICON

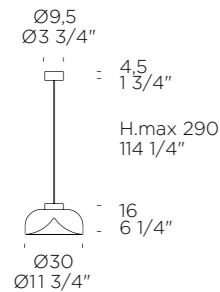

weight-volume 4,4 kg - 0.060 m³

CE IP40

source 1x5W LED 510lm 2700K CRI>90 (included) A++ / A LED

materials blown glass, metal/vetro soffiato, metallo

structure finish	diffuser finish	code	price VAT excluded
gunmetal/canna di fucile	smoke grey/fumé	0008939	520,00 €
chrome/cromo lucido	transparent/trasparente	0008879	490,00 €
gold/dorato lucido	transparent/trasparente	0008883	490,00 €

accessories

off centre kit 3 chrome/kit 3 per decentramento cromato	8000152	16,00 €
off centre kit 3 gold/kit 3 per decentramento dorato	8000137	16,00 €

note

Phase-cut dimmer/Dimmerabile a taglio di fase

AELLA THIN S

Toso & Massari, 2017

ICON

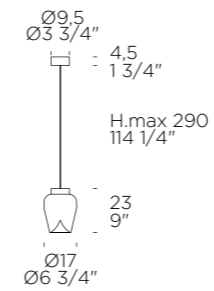

weight-volume 4,4 kg - 0.060 m³

CE IP40

source 1x5W LED 510lm 2700K CRI>90 (included) A++ / A LED

materials blown glass, metal/vetro soffiato, metallo

structure finish	diffuser finish	code	price VAT excluded
gunmetal/canna di fucile	smoke grey/fumé	0008943	480,00 €
chrome/cromo lucido	transparent/trasparente	0008891	450,00 €
gold/dorato lucido	transparent/trasparente	0008893	450,00 €

accessori

off centre kit 3 chrome/kit 3 per decentramento cromato	8000152	16,00 €
off centre kit 3 gold/kit 3 per decentramento dorato	8000137	16,00 €

notes

Phase-cut dimmer/Dimmerabile a taglio di fase

AELLA BOLD S

Toso & Massari, 2017

ICON

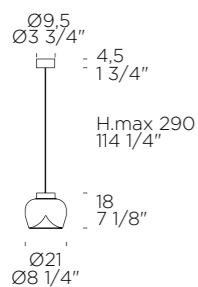

weight-volume 14,9 kg - 0.290 m³

CE IP40

source 1x5W LED 510lm 2700K CRI>90 (included) A++ / A LED

materials blown glass, metal/vetro soffiato, metallo

structure finish	diffuser finish	code	price VAT excluded
gunmetal	smoke grey	0008928	480,00 €
chrome	transparent	0008835	450,00 €
gold	transparent	0008837	450,00 €

accessories

off centre kit 3 chrome/kit 3 per decentramento cromato	8000152	16,00 €
off centre kit 3 gold/kit 3 per decentramento dorato	8000137	16,00 €

notes

Phase-cut dimmer/Dimmerabile a taglio di fase

ALMA S 30

Riccardo Giovanetti, 2009

DESIGN

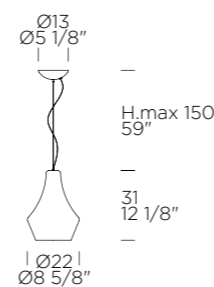

weight-volume 2,7 kg - 0.050 m³

ERL CE IP20

source E14 1x5W Retrofit LED (not included) A+ / E

materials blown glass, metal/vetro soffiato, metallo

structure finish	diffuser finish	code	price VAT excluded
white/bianco	white/bianco	0002322	290,00 €
black/nero	black/nero	0002324	310,00 €

accessories

off centre kit 1 chrome/kit 1 per decentramento cromato	8000150	16,00 €
off centre kit 2 chrome/kit 2 per decentramento cromato	8000135	89,00 €

notes

Maximum supported power/Potenza massima installabile: E14 1xMAX 46W Halo (not included)

ALMA S 60

Riccardo Giovanetti, 2009

DESIGN

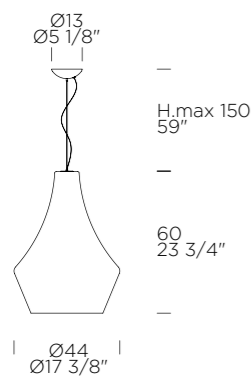

weight-volume 6,6 kg - 0.220 m³



source E27 1x10W Retrofit LED (not included) A+ / E

materials blown glass, metal/*vetro soffiato, metallo*

structure finish	diffuser finish	code	price VAT excluded
white/bianco	white/bianco	0002318	490,00 €
black/nero	black/nero	0002320	550,00 €
accessories			
off centre kit 1 chrome/ <i>kit 1 per decentramento cromato</i>			8000150 16,00 €
off centre kit 2 chrome/ <i>kit 2 per decentramento cromato</i>			8000135 89,00 €

notes

Maximum supported power/*Potenza massima installabile*: E27 1xMAX 77W Halo (not included)

ARIA S 36

Massimo Iosa Ghini, 2010

DESIGN

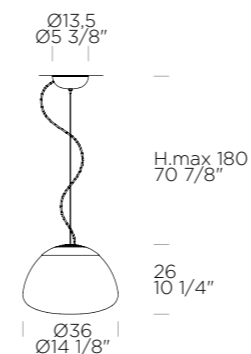

weight-volume 5,1 kg - 0.100 m³



source 3x6W LED 2367lm 3000K CRI 80 (included) A++ / A **LED**

materials blown glass, metal/*vetro soffiato, metallo*

structure finish	diffuser finish	code	price VAT excluded
white/bianco	transparent/ <i>trasparente</i>	0002328	590,00 €
accessories			
off centre kit 1 chrome/ <i>kit 1 per decentramento cromato</i>			8000150 16,00 €

notes

With electronic ballast/*Completa di alimentatore elettronico*

ARIA S 18

Massimo Iosa Ghini, 2010

DESIGN

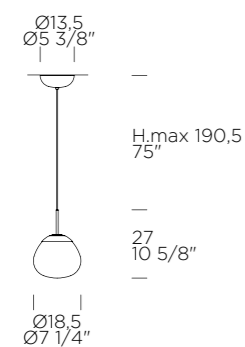

weight-volume 2,8 kg - 0.030 m³



source 1x13W LED 900lm 3000K CRI 80(included) A++ / A **LED**

materials blown glass, metal/*vetro soffiato, metallo*

structure finish	diffuser finish	code	price VAT excluded
white/bianco	transparent/ <i>trasparente</i>	0002326	390,00 €
notes			
With electronic ballast/ <i>Completa di alimentatore elettronico</i>			

ATELIER S

Archirivolto, 2008

TRADITIONAL

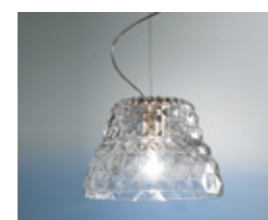
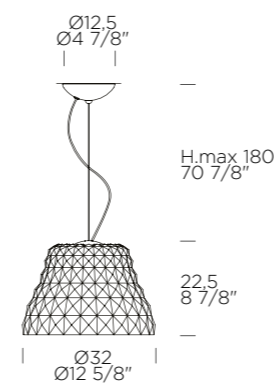

weight-volume 6,5 kg - 0.070 m³



source E27 1x10W Retrofit LED (not included) A+ / E

materials handmade blown glass, metal/*vetro soffiato lavorato a mano, metallo*

structure finish	diffuser finish	code	price VAT excluded
chrome/ <i>cromo lucido</i>	crystal/ <i>cristallo</i>	0000411	753,00 €
accessories			
off centre kit 1 chrome/ <i>kit 1 per decentramento cromato</i>			8000150 16,00 €
off centre kit 2 chrome/ <i>kit 2 per decentramento cromato</i>			8000135 89,00 €
notes			
Maximum supported power/ <i>Potenza massima installabile</i> : E27 1xMAX 77W Halo (not included)			

ATHENA S 1

Crepax & Zanon, 2003

TRADITIONAL

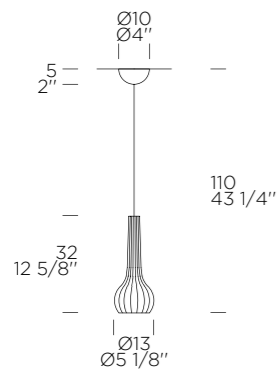

weight-volume 2,2 kg - 0.030 m³

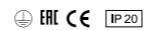

source E14 1x5W Retrofit LED (not included) A+ / E

materials handmade blown glass, metal/*vetro soffiato lavorato a mano, metallo*

structure finish	diffuser finish	code	price VAT excluded
chrome/ <i>cromo lucido</i>	transparent/ <i>trasparente</i>	0000431	401,00 €
gold/ <i>dorato lucido</i>	amber/ <i>ambra</i>	0000433	401,00 €

accessories

off centre kit 3 chrome/ <i>kit 3 per decentramento cromato</i>	8000152	16,00 €
off centre kit 3 gold/ <i>kit 3 per decentramento dorato</i>	8000137	16,00 €

notes

Maximum supported power/*Potenza massima installabile*: E14 1xMAX 46W Halo (not included)

AXEL S

Steven Haulenbeek, 2012

DESIGN

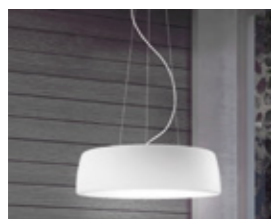
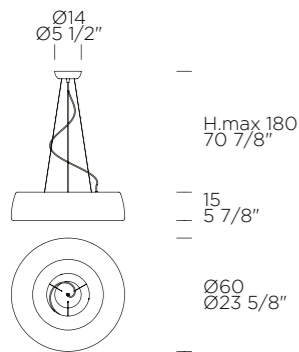

weight-volume 9,5 kg - 0.090 m³

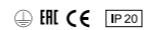

source 1x36W LED 2600lm **3000K** (included) A++ / A **LED**

materials compact polyurethane resin, metal/*resina poliuretanic compatta, metallo*

structure finish	diffuser finish	code	price VAT excluded
white/ <i>bianco</i>	matte white/ <i>bianco opaco</i>	0001616	1.130,00 €
white/ <i>bianco</i>	gloss white/ <i>bianco lucido</i>	0001620	1.130,00 €

notes

With electronic ballast/*Completa di alimentatore elettronico*
Dimmable upon request/*Dimmerabile su richiesta*

weight-volume 9,5 kg - 0.090 m³



source 1x36W LED 2500lm **2700K** (included) A++ / A **LED**

materials compact polyurethane resin, metal/*resina poliuretanic compatta, metallo*

structure finish	diffuser finish	code	price VAT excluded
white/ <i>bianco</i>	matte white/ <i>bianco opaco</i>	0004215	1.130,00 €
white/ <i>bianco</i>	gloss white/ <i>bianco lucido</i>	0004216	1.130,00 €

notes

With electronic ballast/*Completa di alimentatore elettronico*
Dimmable upon request/*Dimmerabile su richiesta*

AYERS S

Marco Piva, 2005

DESIGN

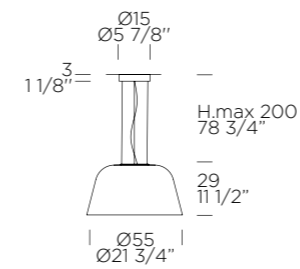

weight-volume 10 kg - 0.170 m³



source E27 1x15W Retrofit LED (not included) A+ / E

materials blown glass, metal/*vetro soffiato, metallo*

structure finish	diffuser finish	code	price VAT excluded
satin nickel/ <i>nichel satinato</i>	gloss white/ <i>bianco lucido</i>	0003063	827,00 €

notes

Maximum supported power/*Potenza massima installabile*: E27 1xMAX 116W Halo (not included)

AYERS S 38

Marco Piva, 2005

DESIGN

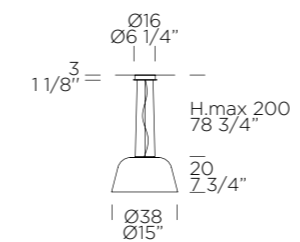

weight-volume 5,3 kg - 0.070 m³



source E27 1x10W Retrofit LED (not included) A+ / E

materials blown glass, metal/*vetro soffiato, metallo*

structure finish	diffuser finish	code	price VAT excluded
satin nickel/ <i>nichel satinato</i>	gloss white/ <i>bianco lucido</i>	0003060	475,00 €

notes

Maximum supported power/*Potenza massima installabile*: E27 1xMAX 100W Halo (not included)

BEAMER S 11

Arik Levy, 2013

DESIGN

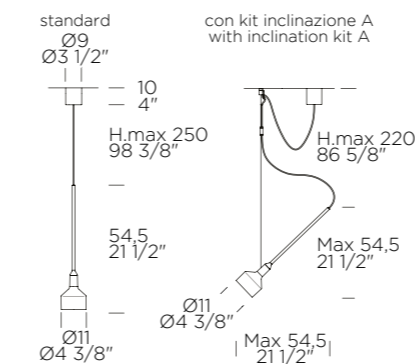

weight-volume 1,45 kg - 0.010 m³



source 1x6W LED 430lm 3000K (included) A++ / A **LED**

materials borosilicate glass, metal/*vetro borosilicato, metallo*

structure finish	diffuser finish	code	price VAT excluded
chrome/ <i>cromo lucido</i>	chromed/ <i>cromatizzato</i>	0003586	475,00 €

accessories

off centre kit 3 chrome/ <i>kit 3 per decentramento cromato</i>	8000152	16,00 €
swang inclination kit A/ <i>kit inclinazione A</i>	8000149	48,00 €

notes

Kit 3 is not included in the price (one Kit 3 is just for one element)/
Kit 3 non è compreso nel prezzo (un Kit 3 vale per un singolo elemento)
Inclination Kit A is not included in the price (one Kit A is just for one element)/
Kit inclinazione A non è compreso nel prezzo (un Kit A vale per un singolo elemento)
With electronic ballast/*Completa di alimentatore elettronico*
Dimmable upon request/*Dimmerabile su richiesta*

BEAMER S 11 - I

Arik Levy, 2013

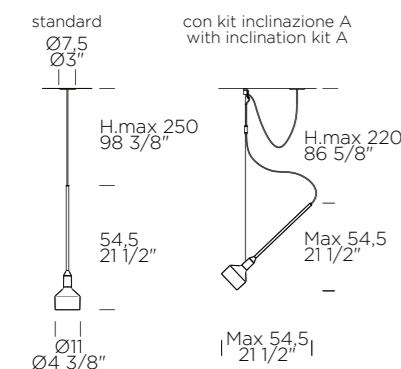
DESIGN**weight-volume** 1,45 kg - 0.010 m³**source** 1x6W LED 430lm 3000K (included) A++ / A **LED****materials** borosilicate glass, metal/*vetro borosilicato, metallo***structure finish****diffuser finish****code****price VAT excluded**chrome/*cromo lucido*chromed/*cromatizzato*

0003598

442,00 €

accessoriesoff centre kit 3 chrome/*kit 3 per decentramento cromato*

8000152

16,00 €

swang inclination kit A/*kit inclinazione A*

8000149

48,00 €

notes

Kit 3 is not included in the price (one Kit 3 is just for one element)/

Kit 3 non è compreso nel prezzo (un Kit 3 vale per un singolo elemento)

Inclination Kit A is not included in the price (one Kit A is just for one element)/

*Kit inclinazione A non è compreso nel prezzo (un Kit A vale per un singolo elemento)*With electronic ballast/*Completa di alimentatore elettronico*Dimmable upon request/*Dimmerabile su richiesta***BEAMER S 17**

Arik Levy, 2013

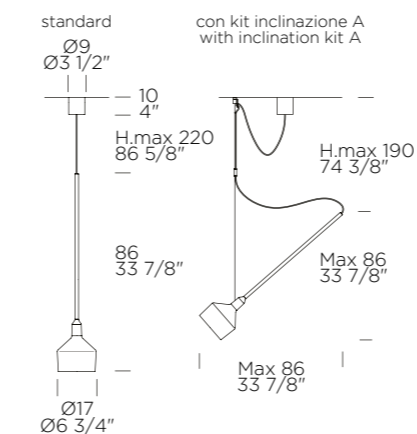
DESIGN**weight-volume** 2,82 kg - 0.050 m³**source** 1x6W LED 430lm 3000K (included) A++ / A **LED****materials** borosilicate glass, metal/*vetro borosilicato, metallo***structure finish****diffuser finish****code****price VAT excluded**chrome/*cromo lucido*chromed/*cromatizzato*

0003600

589,00 €

accessoriesoff centre kit 3 chrome/*kit 3 per decentramento cromato*

8000152

16,00 €

swang inclination kit A/*kit inclinazione A*

8000149

48,00 €

notes

Kit 3 is not included in the price (one Kit 3 is just for one element)/

Kit 3 non è compreso nel prezzo (un Kit 3 vale per un singolo elemento)

Inclination Kit A is not included in the price (one Kit A is just for one element)/

*Kit inclinazione A non è compreso nel prezzo (un Kit A vale per un singolo elemento)*With electronic ballast/*Completa di alimentatore elettronico*Dimmable upon request/*Dimmerabile su richiesta***BEAMER S 11 - R3**

Arik Levy, 2013

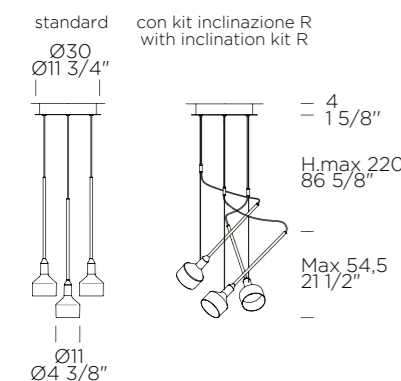
DESIGN**weight-volume** 4,9 kg - 0.080 m³**source** 3x6W LED 1350lm 3000K (included) A++ / A **LED****materials** borosilicate glass, metal/*vetro borosilicato, metallo***structure finish****diffuser finish****code****price VAT excluded**chrome/*cromo lucido*chromed/*cromatizzato*

0003616

1.212,00 €

accessoriesswang inclination kit R/*kit inclinazione R*

8000164

48,00 €

notes

Inclination kit R is not included in the price (one Kit R is just for one element)

*Kit inclinazione R non è compreso nel prezzo (un Kit R vale per un singolo elemento)*With electronic ballast/*Completa di alimentatore elettronico*Dimmable upon request/*Dimmerabile su richiesta***BEAMER S 17 - I**

Arik Levy, 2013

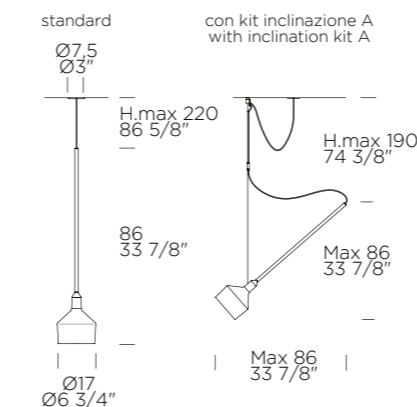
DESIGN**weight-volume** 1,72 kg - 0.010 m³**source** 1x6W LED 430lm 3000K (included) A++ / A **LED****materials** borosilicate glass, metal/*vetro borosilicato, metallo***structure finish****diffuser finish****code****price VAT excluded**chrome/*cromo lucido*chromed/*cromatizzato*

0003612

524,00 €

accessoriesoff centre kit 3 chrome/*kit 3 per decentramento cromato*

8000152

16,00 €

swang inclination kit A/*kit inclinazione A*

8000149

48,00 €

notes

Kit 3 is not included in the price (one Kit 3 is just for one element)/

Kit 3 non è compreso nel prezzo (un Kit 3 vale per un singolo elemento)

Inclination Kit A is not included in the price (one Kit A is just for one element)/

*Kit inclinazione A non è compreso nel prezzo (un Kit A vale per un singolo elemento)*With electronic ballast/*Completa di alimentatore elettronico*Dimmable upon request/*Dimmerabile su richiesta*

BEAMER S 17 - R3

Arik Levy, 2013

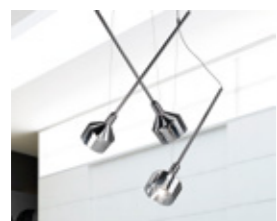
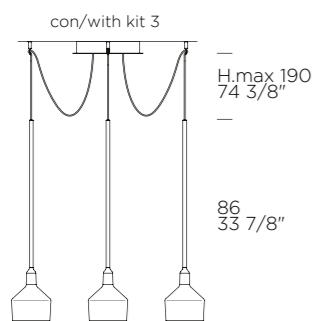
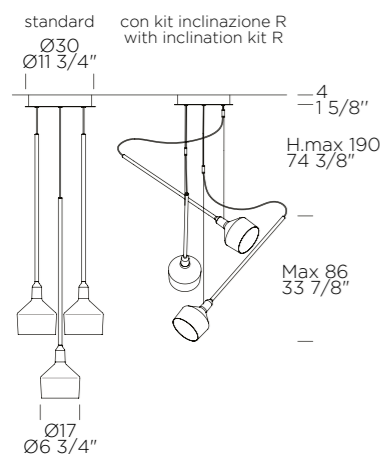
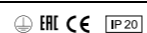
DESIGN**weight-volume** 7 kg - 0.250 m³**source** 3x6W LED 1290lm 3000K (included) A++ / A LED**materials** borosilicate glass, metal/vetro borosilicato, metallo

structure finish	diffuser finish	code	price VAT excluded
chrome/cromo lucido	chromed/cromatizzato	0003604	1.475,00 €

accessories	code	price VAT excluded
off centre kit 3 chrome/kit 3 per decentramento cromato	8000152	16,00 €
swang inclination kit R/kit inclinazione R	8000164	48,00 €

notes
 Kit 3 is not included in the price (one Kit 3 is just for one element)/
 Kit 3 non è compreso nel prezzo (un Kit 3 vale per un singolo elemento)
 Inclination Kit R is not included in the price (one Kit R is just for one element)/
 Kit inclinazione R non è compreso nel prezzo (un Kit R vale per un singolo elemento)
 With electronic ballast/Completa di alimentatore elettronico
 Dimmable upon request/Dimmerabile su richiesta

BOHEME L 12

Oriano Favaretto, 2015

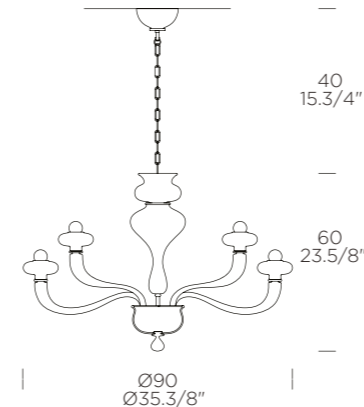
TRADITIONAL**weight-volume** 40,0 kg - 0.230 m³**source** E14 12x5W Retrofit LED (not included) A+ / D**materials** handmade blown glass, metal/vetro soffiato lavorato a mano, metallo

structure finish	diffuser finish	code	price VAT excluded
chrome/cromo lucido	transparent/trasparente	0000784	5.107,00 €
chrome/cromo lucido	smoke grey/fumé	0000785	5.107,00 €

accessories	code	price VAT excluded
chromed chain cm 100 to extend/ catena cromata per allungamento cm 100	8000027	32,00 €

notes
 Smooth glass/Lavorazione liscia
 Free supplied chromed metal chain for extension (cm 45)/
 Fornita di serie catena in metallo cromato per allungamento (cm 45)
 Maximum supporte power/Potenza massima installabile: E14 8xMAX 48W Halo (not included)

BOHEME L 8

Oriano Favaretto, 2015

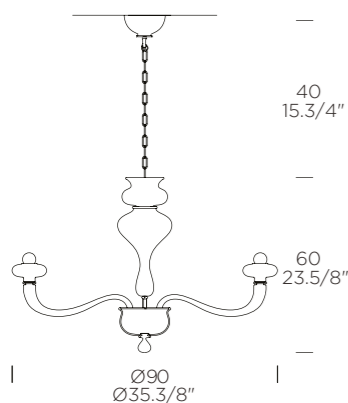
TRADITIONAL**weight-volume** 25,0 kg - 0.200 m³**source** E14 8x5W Retrofit LED (not included) A+ / D**materials** handmade blown glass, metal/vetro soffiato lavorato a mano, metallo

structure finish	diffuser finish	code	price VAT excluded
chrome/cromo lucido	transparent/trasparente	0000781	3.074,00 €
chrome/cromo lucido	smoke grey/fumé	0000782	3.074,00 €

accessories	code	price VAT excluded
chromed chain cm 100 to extend/ catena cromata per allungamento cm 100	8000027	32,00 €

notes
 Smooth glass/Lavorazione liscia
 Free supplied chromed metal chain for extension (cm 45)/
 Fornita di serie catena in metallo cromato per allungamento (cm 45)
 Maximum supporte power/Potenza massima installabile: E14 8xMAX 48W Halo (not included)

BOLERO L 6

Carlo Nason, 2005

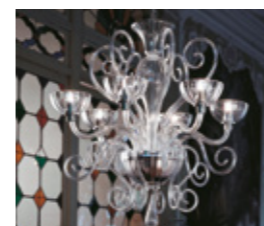
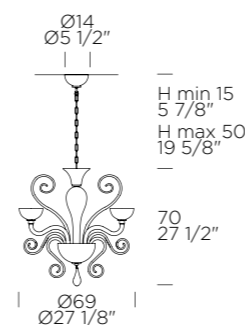
TRADITIONAL**weight-volume** 17,8 kg - 0.230 m³**source** G9 6x3W Retrofit LED (not included) A+ / D
+ G4 3xMAX 20W (non inclusa)**materials** handmade blown glass, metal/vetro soffiato lavorato a mano, metallo

structure finish	diffuser finish	code	price VAT excluded
chrome/cromo lucido	transparent/trasparente	0000675	2.697,00 €
chrome/cromo lucido	gloss white/bianco lucido	0000679	2.943,00 €

accessories	code	price VAT excluded
chromed chain cm 100 to extend/ catena cromata per allungamento cm 100	8000027	32,00 €

notes
 Crystal pressed in ribs. Milky white smooth/
 Lavorazione a coste per versione cristallo. Lavorazione liscia per versione biancolatte
 Free supplied chromed metal chain for extension (cm 60)/
 Fornita di serie catena in metallo cromato per allungamento (cm 60)
 Maximum supporte power/Potenza massima installabile: G9 6xMAX 60W Halo (not included)

BOLERO L 9

Carlo Nason, 2006

TRADITIONAL

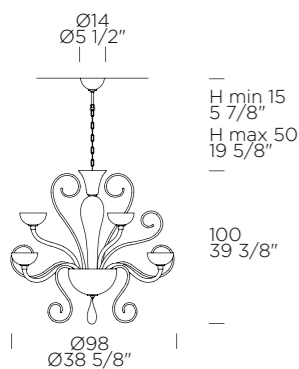

weight-volume 26 kg - 0.340 m³



source G9 9x3W Retrofit LED (not included) A+ / D
+ G4 3xMAX 20W (non inclusa)

materials handmade blown glass, metal/vetro soffiato lavorato a mano, metallo

structure finish	diffuser finish	code	price VAT excluded
chrome/cromo lucido	transparent/trasparente	0000755	3.844,00 €
chrome/cromo lucido	gloss white/bianco lucido	0000757	4.090,00 €

accessories
chromed chain cm 100 to extend/
catena cromata per allungamento cm 100 8000027 32,00 €

notes
Crystal pressed in ribs. Milky white smooth/
Lavorazione a coste per versione cristallo. Lavorazione liscia per versione biancolatte
Free supplied chromed metal chain for extension (cm 60)/
Fornita di serie catena in metallo cromato per allungamento (cm 60)
Maximum supported power/Potenza massima installabile: G9 6xMAX 60W Halo (not included)

CLASS S 60

Leucos Design Lab, 2001

DESIGN

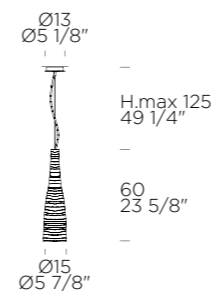

weight-volume 4,3 kg - 0.050 m³



source E27 1x15W Retrofit LED (not included) A+ / E

materials blown and layered glass with handmade grinding, metal/
vetro soffiato e incamiciato con molatura eseguita a mano, metallo

structure finish	diffuser finish	code	price VAT excluded
grey/grigio	satin milky white/ biancolatte satinato	0001584	548,00 €
grey/grigio	silver/argento	0001589	548,00 €
grey/grigio	transparent/trasparente	0001579	565,00 €
grey/grigio	mirror/specchio	0001574	688,00 €

accessories
off centre kit 1 chrome/kit 1 per decentramento cromato 8000150 16,00 €
off centre kit 1 brushed nickel/kit 1 per decentramento nichel satinato 8000151 16,00 €
off centre kit 2 brushed nickel/kit 2 per decentramento nichel satinato 8000136 81,00 €
off centre kit 2 chrome/kit 2 per decentramento cromato 8000135 89,00 €

notes
Satin finish/Finitura satinata
Maximum supported power/Potenza massima installabile: E27 1xMAX 100W Halo (not included)

CLASS S 40

Leucos Design Lab, 2001

DESIGN

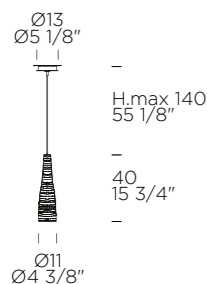

weight-volume 3,4 kg - 0.060 m³



source E14 1x5W Retrofit LED (not included) A+ / E

materials blown and layered glass with handmade grinding, metal/
vetro soffiato e incamiciato con molatura eseguita a mano, metallo

structure finish	diffuser finish	code	price VAT excluded
grey/grigio	satin milky white/ biancolatte satinato	0001583	335,00 €
grey/grigio	silver/argento	0001588	335,00 €
grey/grigio	transparent/trasparente	0001578	352,00 €
grey/grigio	mirror/specchio	0001573	475,00 €

accessories
off centre kit 3 chrome/kit 3 per decentramento cromato 8000152 16,00 €
off centre kit 3 brushed nickel/kit 3 per decentramento nichel satinato 8000153 16,00 €

notes
Satin finish/Finitura satinata
Maximum supported power/Potenza massima installabile: E14 1xMAX 60W Halo (not included)

CLOCHE S

Danilo De Rossi, 2013

DESIGN

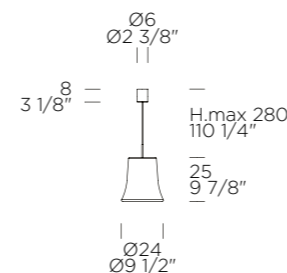

weight-volume 2,4 kg - 0.050 m³



source E27 1x10W Retrofit LED (not included) A+ / E

materials borosilicate glass, metal/vetro borosilicato, metallo

structure finish	diffuser finish	code	price VAT excluded
chrome/cromo lucido	chromed/cromatizzato	0003579	762,00 €
copper/ramato	copper/ramato	0003581	835,00 €

accessories
off centre kit 3 chrome/kit 3 per decentramento cromato 8000152 16,00 €
off centre kit 3 gold/kit 3 per decentramento dorato 8000137 16,00 €

notes
Maximum supported power/Potenza massima installabile: E27 1xMAX 100W Halo (not included)

CLOCHEF S

Massimo Iosa Ghini, 2018

DESIGN

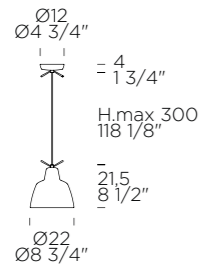

weight-volume	1,5 kg - 0.060 m ³	CE	IP40
source	E27 1x10W Retrofit LED (not included) A+ / E		
materials	aluminum or natural copper, steel handles/ <i>alluminio o rame naturale, maniglie in acciaio</i>		
structure finish	diffuser finish	code	price VAT excluded
gloss white RAL 9003 <i>bianco lucido RAL 9003</i>	gloss white RAL 9003 <i>bianco lucido RAL 9003</i>	0009159	259,00 €
gloss black RAL 9005 <i>nero lucido RAL 9005</i>	gloss black RAL 9005 <i>nero lucido RAL 9005</i>	0010053	329,00 €
varnished brushed copper <i>rame naturale spazzolato lucidato</i>	varnished brushed copper <i>rame naturale spazzolato lucidato</i>	0010080	432,00 €
accessories			
off centre kit 3 chrome/ <i>kit 3 per decentramento cromato</i>		8000152	16,00 €
off centre kit 3 brushed nickel/ <i>kit 3 per decentramento nickel satinato</i>		8000153	16,00 €

notes

Black cable for glossy black and natural copper versions. Grey cable for glossy white version/*Cavo nero per versioni nero lucido e rame naturale. Cavo grigio per versione bianco lucido*
Glossy black handles for glossy black and natural copper versions. Glossy white handles for glossy white version/*Maniglie nero lucido per versioni nero lucido e rame naturale. Maniglie bianco lucido per versione bianco lucido*
Maximum supported power/*Potenza massima installabile*: E27 1x46W Halo (not included)

weight-volume	1,5 kg - 0.060 m ³	CE	IP40
source	1x8W LED 600lm 2700K (included) A+ LED		
materials	aluminum or natural copper, steel handles/ <i>alluminio o rame naturale, maniglie in acciaio</i>		
structure finish	diffuser finish	code	price VAT excluded
gloss white RAL 9003 <i>bianco lucido RAL 9003</i>	gloss white RAL 9003 <i>bianco lucido RAL 9003</i>	0009358	369,00 €
gloss black RAL 9005 <i>nero lucido RAL 9005</i>	gloss black RAL 9005 <i>nero lucido RAL 9005</i>	0010056	416,00 €
varnished brushed copper <i>rame naturale spazzolato lucidato</i>	varnished brushed copper <i>rame naturale spazzolato lucidato</i>	0010078	542,00 €
accessories			
off centre kit 3 chrome/ <i>kit 3 per decentramento cromato</i>		8000152	16,00 €
off centre kit 3 brushed nickel/ <i>kit 3 per decentramento nickel satinato</i>		8000153	16,00 €

notes

Black cable for glossy black and natural copper versions. Grey cable for glossy white version/*Cavo nero per versioni nero lucido e rame naturale. Cavo grigio per versione bianco lucido*
Glossy black handles for glossy black and natural copper versions. Glossy white handles for glossy white version/*Maniglie nero lucido per versioni nero lucido e rame naturale. Maniglie bianco lucido per versione bianco lucido*

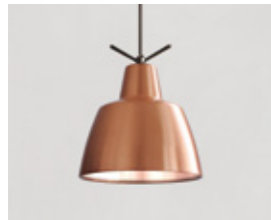

CUBI S 11

Leucos Design Lab, 2000

DESIGN

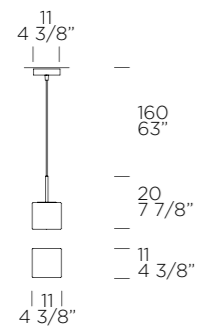

weight-volume	1 kg - 0.020 m ³	CE	IP20
source	G9 1x3W Retrofit LED (not included) A+ / D		
materials	blown glass, metal/ <i>vetro soffiato, metallo</i>		
structure finish	diffuser finish	code	price VAT excluded
artic grey/ <i>grigio artico</i>	satin white/ <i>bianco satinato</i>	0001569	170,00 €
accessories			
off centre kit 3 chrome/ <i>kit 3 per decentramento cromato</i>		8000152	16,00 €
off centre kit 3 brushed nickel/ <i>kit 3 per decentramento nickel satinato</i>		8000153	16,00 €
notes			
Satin finish/ <i>Finitura satinata</i> Maximum supported power/ <i>Potenza massima installabile</i> : G9 1xMAX 60W Halo (not included)			



CUBI S 16

Leucos Design Lab, 2000

DESIGN

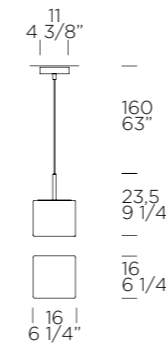

weight-volume	2 kg - 0.040 m ³	CE	IP20
source	E14 1x5W Retrofit LED (not included) A+ / E		
materials	blown glass, metal/ <i>vetro soffiato, metallo</i>		
structure finish	diffuser finish	code	price VAT excluded
artic grey/ <i>grigio artico</i>	satin white/ <i>bianco satinato</i>	0001568	210,00 €
accessories			
off centre kit 3 chrome/ <i>kit 3 per decentramento cromato</i>		8000152	16,00 €
off centre kit 3 brushed nickel/ <i>kit 3 per decentramento nickel satinato</i>		8000153	16,00 €
notes			
Satin finish/ <i>Finitura satinata</i> Maximum supported power/ <i>Potenza massima installabile</i> : E14 1xMAX 60W Halo (not included)			

DELUXE S 35

Archirivolto, 2006

DESIGN

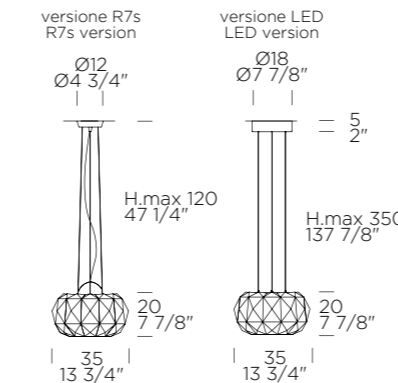

weight-volume	6,5 kg - 0.090 m ³	CE	IP20
source	R7s 80mm 1x10W Retrofit LED (not included) A+ / D		
materials	blown glass, metal/ <i>vetro soffiato, metallo</i>		
structure finish	diffuser finish	code	price VAT excluded
chrome/ <i>cromo lucido</i>	satin white/ <i>bianco satinato</i>	0002352	581,00 €
chrome/ <i>cromo lucido</i>	matte black/ <i>nero opaco</i>	0002356	606,00 €
notes			
Maximum supported power/ <i>Potenza massima installabile</i> : R7s 80mm 1xMAX 120W Halo (not included)			
weight-volume	5 kg - 0.070 m ³	CE	IP20
source	1x19W LED 2400lm 3000K CRI 80 (included) A++ / A LED		
materials	blown glass, metal/ <i>vetro soffiato, metallo</i>		
structure finish	diffuser finish	code	price VAT excluded
chrome/ <i>cromo lucido</i>	matte black/ <i>nero opaco</i>	0008126	1.016,00 €
chrome/ <i>cromo lucido</i>	satin white/ <i>bianco satinato</i>	0008125	999,00 €
notes			
1-10V dimmable/ <i>Dimmerabile 1-10V</i> 0-100% dimmable with external button (the latter is not supplied)/ <i>Dimmerabile 0-100% con pulsante esterno (pulsante esterno non fornito)</i> DALI dimmable/ <i>Dimmerabile DALI</i> With electronic ballast/ <i>Completa di alimentatore elettronico</i> Cable Insulation Kit included/ <i>Kit isolamento cavo incluso</i>			

DELUXE S 50

Archirivolto, 2006

DESIGN

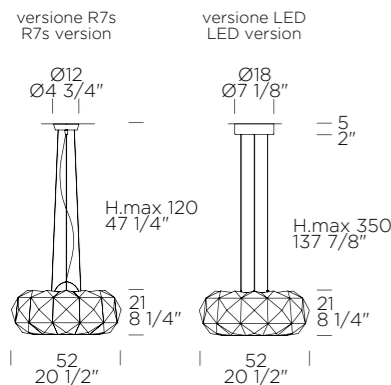

weight-volume	8,4 kg - 0.150 m ³	
source	R7s 114mm 1x10W Retrofit LED (not included) A+ / D	
materials	blown glass, metal/ <i>vetro soffiato, metallo</i>	
structure finish		price VAT excluded
	chrome/ <i>cromo lucido</i>	827,00 €
	satin white/ <i>bianco satinato</i>	
	matte black/ <i>nero opaco</i>	901,00 €
code	0002353	
code	0002357	
notes	Maximum supported power/ <i>Potenza massima installabile</i> : R7s 114mm 1xMAX 230W Halo (not included)	

weight-volume	18,4 kg - 0.250 m ³	
source	1x29W LED 3300lm 3000K CRI 80 (included) A++ / A LED	
materials	blown glass, metal/ <i>vetro soffiato, metallo</i>	
structure finish		price VAT excluded
	chrome/ <i>cromo lucido</i>	1.171,00 €
	satin white/ <i>bianco satinato</i>	
	matte black/ <i>nero opaco</i>	1.204,00 €
code	0008124	
code	0008123	

notes
1-10V dimmable/*Dimmerabile 1-10V*
0-100% dimmable with external button (the latter is not supplied)/*Dimmerabile 0-100% con pulsante esterno (pulsante esterno non fornito)*
DALI dimmable/*Dimmerabile DALI*
With electronic ballast/*Completa di alimentatore elettronico*
Cable Insulation Kit included/*Kit isolamento cavo incluso*

ETHER S

Patrick Jouin, 2007

DESIGN

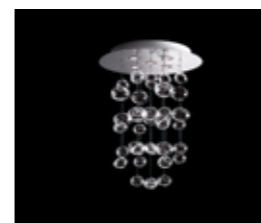
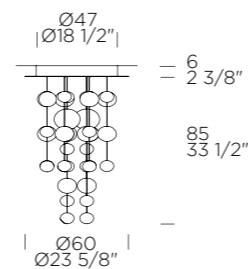

weight-volume	29,9 kg - 0.430 m ³	
source	GU10 5x7W Retrofit LED (not included) A+	
materials	handmade borosilicate blown glass, steel/ <i>vetro borosilicato soffiato lavorato a mano, acciaio</i>	
structure finish		price VAT excluded
	polished steel/ <i>acciaio lucido</i>	1.959,00 €
	transparent/ <i>trasparente</i>	
code	0010070	
notes	Special version upon request. For more details view "SPECIAL VERSIONS" chapter <i>A richiesta versioni speciali. Per maggiori dettagli vedi capitolo "VERSIONI SPECIALI"</i>	

ETHER S 90

Patrick Jouin, 2006

DESIGN

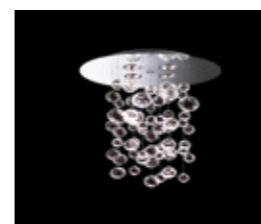
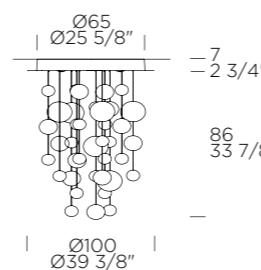

weight-volume	46,6 kg - 0.670 m ³	
source	G53 4x15W Retrofit LED not included) A+ / A + GU5,3 1x8W Retrofit LED RGB 660lm (non inclusa)	
materials	handmade borosilicate blown glass, steel/ <i>vetro borosilicato soffiato lavorato a mano, acciaio</i>	
structure finish		price VAT excluded
	polished steel/ <i>acciaio lucido</i>	3.680,00 €
	transparent/ <i>trasparente</i>	
code	0010065	
notes	Kit 4 flange included/ <i>Kit 4 flange incluso</i> Special version upon request. For more details view "SPECIAL VERSIONS" chapter <i>A richiesta versioni speciali. Per maggiori dettagli vedi capitolo "VERSIONI SPECIALI"</i> LED with RGB + remote control (usable until 5 m)/ <i>LED con RGB + telecomando (utilizzabile fino a 5 m)</i>	

weight-volume	46,6 kg - 0.670 m ³	
source	G53 4x15W Retrofit LED 3200lm (not included) A	
materials	handmade borosilicate blown glass, steel/ <i>vetro borosilicato soffiato lavorato a mano, acciaio</i>	
structure finish		price VAT excluded
	polished steel/ <i>acciaio lucido</i>	3.353,00 €
	transparent/ <i>trasparente</i>	
code	0010064	
notes	Kit 4 flange included/ <i>Kit 4 flange incluso</i> Special version upon request. For more details view "SPECIAL VERSIONS" chapter <i>A richiesta versioni speciali. Per maggiori dettagli vedi capitolo "VERSIONI SPECIALI"</i>	

ELYSEE L 12

Marina Toscano, 2009

TRADITIONAL

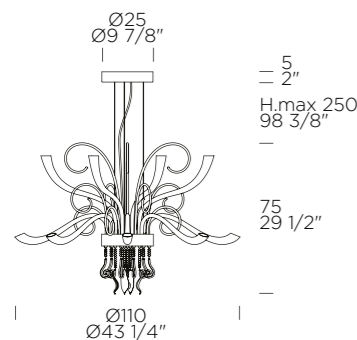

weight-volume	19,65 kg - 0.300 m ³	
source	1x40W LED 2700lm 3000K (included) A++ / A LED + 1x7,5W LED 600lm 3000K (inclusa)	
materials	handmade blown glass, metal/ <i>vetro soffiato lavorato a mano, metallo</i>	
structure finish		price VAT excluded
	chrome/ <i>cromo lucido</i>	5.812,00 €
	transparent/ <i>trasparente</i>	
code	0000777	

notes
1-10V dimmable/*Dimmerabile 1-10V*
With electronic ballast/*Completa di alimentatore elettronico*
1-100% dimmable with external button (the latter is not supplied)
Dimmerabile 0-100% con pulsante esterno (pulsante esterno non fornito)
Double switch/*Doppia accensione*

ETHER S 150

Patrick Jouin, 2006

DESIGN

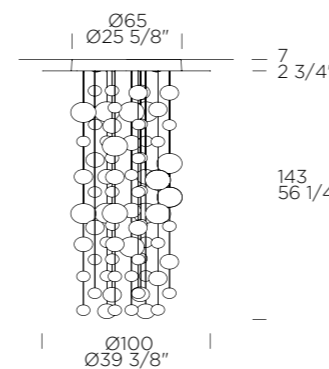

weight-volume	54,3 kg - 1.000 m ³	
source	G53 4x15W Retrofit LED (not included) A+ / A + GU5,3 1x8W Retrofit LED RGB (non inclusa)	
materials	handmade borosilicate blown glass, steel	
structure finish		price VAT excluded
	polished steel/ <i>acciaio lucido</i>	5.238,00 €
	transparent/ <i>trasparente</i>	
code	0010061	
notes	Kit 4 flange included/ <i>Kit 4 flange incluso</i> Special version upon request. For more details view "SPECIAL VERSIONS" chapter <i>A richiesta versioni speciali. Per maggiori dettagli vedi capitolo "VERSIONI SPECIALI"</i> LED with RGB + remote control (usable until 5 m)/ <i>LED con RGB + telecomando (utilizzabile fino a 5 m)</i>	

weight-volume	54,3 kg - 1.000 m ³	
source	G53 4x15W Retrofit LED (not included) A	
materials	handmade borosilicate blown glass, steel	
structure finish		price VAT excluded
	polished steel/ <i>acciaio lucido</i>	4.828,00 €
	transparent/ <i>trasparente</i>	
code	0010060	
notes	Kit 4 flange included/ <i>Kit 4 flange incluso</i> Special version upon request. For more details view "SPECIAL VERSIONS" chapter <i>A richiesta versioni speciali. Per maggiori dettagli vedi capitolo "VERSIONI SPECIALI"</i>	

FAIRY S C

Toso, Massari & Associates With G. Toso, 2009

DESIGN

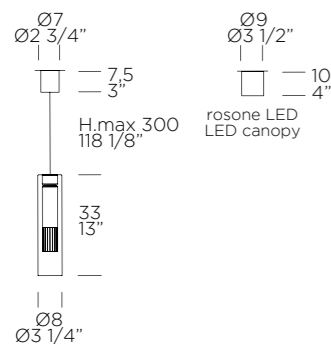

weight-volume 2,4 kg - 0.030 m³



source **GU4** 1x4W Retrofit LED (not included) A+ / B

materials borosilicate glass, metal/*vetro borosilicato, metallo*

structure finish	diffuser finish	code	price VAT excluded
<input checked="" type="checkbox"/> chrome/ <i>cromo lucido</i>	<input type="checkbox"/> transparent/ <i>trasparente</i>	0003262	295,00 €

accessories
off centre kit 3 chrome/*kit 3 per decentramento cromato* 8000152 16,00 €

notes
Dimmable transformer included/*Trasformatore dimmerabile compreso*
Phase cut dimming with dimmable light bulb only/*Dimmerabile a taglio di fase con lampadina compatibile*
Special version upon request. For more details view "SPECIAL VERSIONS" chapter
A richiesta versioni speciali. Per maggiori dettagli vedi capitolo "VERSIONI SPECIALI"
Maximum supported power/*Potenza massima installabile*: GU4 1xMAX 35W Halo (not included)

weight-volume 2,4 kg - 0.030 m³



source 1x3,2W **LED** 410lm 3000K CRI>80 (included - replaceable LED) A++ **LED**

materials borosilicate glass, metal/*vetro borosilicato, metallo*

structure finish	diffuser finish	code	price VAT excluded
<input checked="" type="checkbox"/> chrome/ <i>cromo lucido</i>	<input type="checkbox"/> transparent/ <i>trasparente</i>	0009033	390,00 €

accessories
off centre kit 3 chrome/*kit 3 per decentramento cromato* 8000152 16,00 €

notes
With electronic ballast/*Completa di alimentatore elettronico*
Phase cut dimming/*Dimmerabile a taglio di fase*
Special version upon request. For more details view "SPECIAL VERSIONS" chapter
A richiesta versioni speciali. Per maggiori dettagli vedi capitolo "VERSIONI SPECIALI"



FAIRY S C - I

Toso, Massari & Associates With G. Toso, 2009

DESIGN

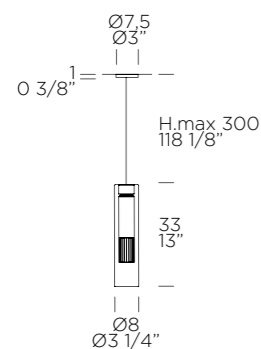

weight-volume 2,1 kg - 0.030 m³



source **GU4** 1x4W Retrofit LED (not included) A+ / B

materials borosilicate glass, metal/*vetro borosilicato, metallo*

structure finish	diffuser finish	code	price VAT excluded
<input checked="" type="checkbox"/> chrome/ <i>cromo lucido</i>	<input type="checkbox"/> transparent/ <i>trasparente</i>	0003284	310,00 €

accessories
off centre kit 3 chrome/*kit 3 per decentramento cromato* 8000152 16,00 €

notes
Dimmable transformer included/*Trasformatore dimmerabile compreso*
Phase cut dimming with dimmable light bulb only/*Dimmerabile a taglio di fase con lampadina compatibile*
Special version upon request. For more details view "SPECIAL VERSIONS" chapter
A richiesta versioni speciali. Per maggiori dettagli vedi capitolo "VERSIONI SPECIALI"
Maximum supported power/*Potenza massima installabile*: GU4 1xMAX 35W Halo (not included)

weight-volume 2,1 kg - 0.030 m³



source 1x3,2W **LED** 410lm 3000K CRI>80 (included - replaceable LED) A++ **LED**

materials borosilicate glass, metal/*vetro borosilicato, metallo*

structure finish	diffuser finish	code	price VAT excluded
<input checked="" type="checkbox"/> chrome/ <i>cromo lucido</i>	<input type="checkbox"/> transparent/ <i>trasparente</i>	0009105	390,00 €

accessories
off centre kit 3 chrome/*kit 3 per decentramento cromato* 8000152 16,00 €

notes
With electronic ballast/*Completa di alimentatore elettronico*
Phase cut dimming/*Dimmerabile a taglio di fase*
Special version upon request. For more details view "SPECIAL VERSIONS" chapter
A richiesta versioni speciali. Per maggiori dettagli vedi capitolo "VERSIONI SPECIALI"



FAIRY S C - D3

Toso, Massari & Associates With G. Toso, 2009

DESIGN

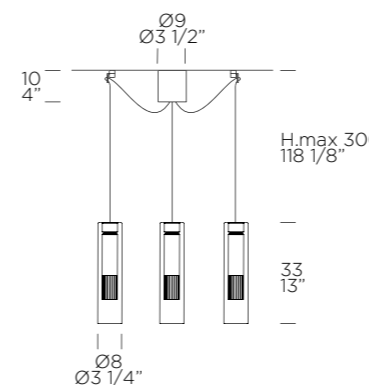

weight-volume 6,81 kg - 0.100 m³



source **GU4** 3x4W Retrofit LED (non inclusa) A+ / B

materials borosilicate glass, metal/*vetro borosilicato, metallo*

structure finish	diffuser finish	code	price VAT excluded
<input checked="" type="checkbox"/> chrome/ <i>cromo lucido</i>	<input type="checkbox"/> transparent/ <i>trasparente</i>	0003264	850,00 €

notes
Dimmable transformer included/*Trasformatore dimmerabile compreso*
Phase cut dimming with dimmable light bulb only/*Dimmerabile a taglio di fase con lampadina compatibile*
Special version upon request. For more details view "SPECIAL VERSIONS" chapter
A richiesta versioni speciali. Per maggiori dettagli vedi capitolo "VERSIONI SPECIALI"
Maximum supported power/*Potenza massima installabile*: GU4 3xMAX 35W Halo (not included)

weight-volume 6,81 kg - 0.100 m³



source 3x3,2W **LED** 1230lm 3000K CRI>80 (included - replaceable LED) A++ **LED**

materials borosilicate glass, metal/*vetro borosilicato, metallo*

structure finish	diffuser finish	code	price VAT excluded
<input checked="" type="checkbox"/> chrome/ <i>cromo lucido</i>	<input type="checkbox"/> transparent/ <i>trasparente</i>	0009028	990,00 €

notes
With electronic ballast/*Completa di alimentatore elettronico*
Phase cut dimming/*Dimmerabile a taglio di fase*
Special version upon request. For more details view "SPECIAL VERSIONS" chapter
A richiesta versioni speciali. Per maggiori dettagli vedi capitolo "VERSIONI SPECIALI"



FAIRY S G

Toso, Massari & Associates With G. Toso, 2009

DESIGN

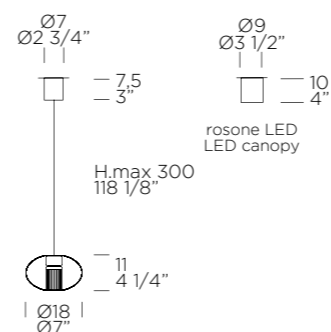

weight-volume 2,2 kg - 0.030 m³



source **GU4** 1x4W Retrofit LED (not included) A+ / B

materials borosilicate glass, metal/*vetro borosilicato, metallo*

structure finish	diffuser finish	code	price VAT excluded
<input checked="" type="checkbox"/> chrome/ <i>cromo lucido</i>	<input type="checkbox"/> transparent/ <i>trasparente</i>	0003270	295,00 €

accessories
off centre kit 3 chrome/*kit 3 per decentramento cromato* 8000152 16,00 €

notes
Dimmable transformer included/*Trasformatore dimmerabile compreso*
Phase cut dimming with dimmable light bulb only/*Dimmerabile a taglio di fase con lampadina compatibile*
Special version upon request. For more details view "SPECIAL VERSIONS" chapter
A richiesta versioni speciali. Per maggiori dettagli vedi capitolo "VERSIONI SPECIALI"
Maximum supported power/*Potenza massima installabile*: GU4 1xMAX 35W Halo (not included)

weight-volume 2,4 kg - 0.030 m³



source 1x3,2W **LED** 410lm 3000K CRI>80 (included - replaceable LED) A++ **LED**

materials borosilicate glass, metal/*vetro borosilicato, metallo*

structure finish	diffuser finish	code	price VAT excluded
<input checked="" type="checkbox"/> chrome/ <i>cromo lucido</i>	<input type="checkbox"/> transparent/ <i>trasparente</i>	0009053	390,00 €

accessories
off centre kit 3 chrome/*kit 3 per decentramento cromato* 8000152 16,00 €

notes
With electronic ballast/*Completa di alimentatore elettronico*
Phase cut dimming/*Dimmerabile a taglio di fase*
Special version upon request. For more details view "SPECIAL VERSIONS" chapter
A richiesta versioni speciali. Per maggiori dettagli vedi capitolo "VERSIONI SPECIALI"



FAIRY S G - I

Toso, Massari & Associates With G. Toso, 2009

DESIGN

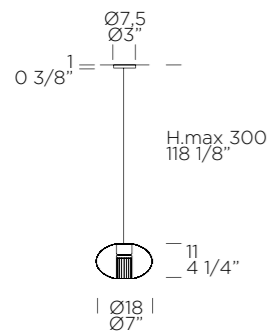

weight-volume	2,1 kg - 0.030 m ³			
source	GU4 1x4W Retrofit LED (not included) A+ / B			
materials	borosilicate glass, metal/ <i>vetro borosilicato, metallo</i>			
structure finish	<input checked="" type="checkbox"/> chrome/ <i> Cromo lucido</i>	diffuser finish	<input type="checkbox"/> transparent/ <i> trasparente</i>	code
				0003290
price VAT excluded				310,00 €
accessories	off centre kit 3 chrome/ <i>kit 3 per decentramento cromato</i>	code		8000152
				16,00 €
notes	Dimmable transformer included/ <i>Trasformatore dimmerabile compreso</i> Phase cut dimming with dimmable light bulb only/ <i>Dimmerabile a taglio di fase con lampadina compatibile</i> Special version upon request. For more details view "SPECIAL VERSIONS" chapter <i>A richiesta versioni speciali. Per maggiori dettagli vedi capitolo "VERSIONI SPECIALI"</i> Maximum supported power/ <i>Potenza massima installabile</i> : GU4 1xMAX 35W Halo (not included)			

weight-volume	2,1 kg - 0.030 m ³		
source	1x3,2W LED 410lm 3000K CRI>80 (included - replaceable LED) A++ LED		
materials	borosilicate glass, metal/ <i>vetro borosilicato, metallo</i>		
structure finish	<input checked="" type="checkbox"/> chrome/ <i> Cromo lucido</i>	diffuser finish	<input type="checkbox"/> transparent/ <i> trasparente</i>
price VAT excluded			
code	0009058		
price VAT excluded			
accessories	off centre kit 3 chrome/ <i>kit 3 per decentramento cromato</i>	code	
price VAT excluded			
code	8000152		
price VAT excluded			
accessories	off centre kit 3 chrome/ <i>kit 3 per decentramento cromato</i>	code	
price VAT excluded			
code	8000152		
price VAT excluded			
accessories	off centre kit 3 chrome/ <i>kit 3 per decentramento cromato</i>	code	
price VAT excluded			
code	8000152		
price VAT excluded			
accessories	off centre kit 3 chrome/ <i>kit 3 per decentramento cromato</i>	code	
price VAT excluded			
code	8000152		
price VAT excluded			
accessories	off centre kit 3 chrome/ <i>kit 3 per decentramento cromato</i>	code	
price VAT excluded			
code	8000152		
price VAT excluded			
accessories	off centre kit 3 chrome/ <i>kit 3 per decentramento cromato</i>	code	
price VAT excluded			
code	8000152		
price VAT excluded			
accessories	off centre kit 3 chrome/ <i>kit 3 per decentramento cromato</i>	code	
price VAT excluded			
code	8000152		
price VAT excluded			
accessories	off centre kit 3 chrome/ <i>kit 3 per decentramento cromato</i>	code	
price VAT excluded			
code	8000152		
price VAT excluded			
accessories	off centre kit 3 chrome/ <i>kit 3 per decentramento cromato</i>	code	
price VAT excluded			
code	8000152		
price VAT excluded			
accessories	off centre kit 3 chrome/ <i>kit 3 per decentramento cromato</i>	code	
price VAT excluded			
code	8000152		
price VAT excluded			
accessories	off centre kit 3 chrome/ <i>kit 3 per decentramento cromato</i>	code	
price VAT excluded			
code	8000152		
price VAT excluded			
accessories	off centre kit 3 chrome/ <i>kit 3 per decentramento cromato</i>	code	
price VAT excluded			
code	8000152		
price VAT excluded			
accessories	off centre kit 3 chrome/ <i>kit 3 per decentramento cromato</i>	code	
price VAT excluded			
code	8000152		
price VAT excluded			
accessories	off centre kit 3 chrome/ <i>kit 3 per decentramento cromato</i>	code	
price VAT excluded			
code	8000152		
price VAT excluded			
accessories	off centre kit 3 chrome/ <i>kit 3 per decentramento cromato</i>	code	
price VAT excluded			
code	8000152		
price VAT excluded			
accessories	off centre kit 3 chrome/ <i>kit 3 per decentramento cromato</i>	code	
price VAT excluded			
code	8000152		
price VAT excluded			
accessories	off centre kit 3 chrome/ <i>kit 3 per decentramento cromato</i>	code	
price VAT excluded			
code	8000152		
price VAT excluded			
accessories	off centre kit 3 chrome/ <i>kit 3 per decentramento cromato</i>	code	
price VAT excluded			
code	8000152		
price VAT excluded			
accessories	off centre kit 3 chrome/ <i>kit 3 per decentramento cromato</i>	code	
price VAT excluded			
code	8000152		
price VAT excluded			
accessories	off centre kit 3 chrome/ <i>kit 3 per decentramento cromato</i>	code	
price VAT excluded			
code	8000152		
price VAT excluded			
accessories	off centre kit 3 chrome/ <i>kit 3 per decentramento cromato</i>	code	
price VAT excluded			
code	8000152		
price VAT excluded			
accessories	off centre kit 3 chrome/ <i>kit 3 per decentramento cromato</i>	code	
price VAT excluded			
code	8000152		
price VAT excluded			
accessories	off centre kit 3 chrome/ <i>kit 3 per decentramento cromato</i>	code	
price VAT excluded			
code	8000152		
price VAT excluded			
accessories	off centre kit 3 chrome/ <i>kit 3 per decentramento cromato</i>	code	
price VAT excluded			
code	8000152		
price VAT excluded			
accessories	off centre kit 3 chrome/ <i>kit 3 per decentramento cromato</i>	code	
price VAT excluded			
code	8000152		
price VAT excluded			
accessories	off centre kit 3 chrome/ <i>kit 3 per decentramento cromato</i>	code	
price VAT excluded			
code	8000152		
price VAT excluded			
accessories	off centre kit 3 chrome/ <i>kit 3 per decentramento cromato</i>	code	
price VAT excluded			
code	8000152		
price VAT excluded			
accessories	off centre kit 3 chrome/ <i>kit 3 per decentramento cromato</i>	code	
price VAT excluded			
code	8000152		
price VAT excluded			
accessories	off centre kit 3 chrome/ <i>kit 3 per decentramento cromato</i>	code	
price VAT excluded			
code	8000152		
price VAT excluded			
accessories	off centre kit 3 chrome/ <i>kit 3 per decentramento cromato</i>	code	
price VAT excluded			
code	8000152		
price VAT excluded			
accessories	off centre kit 3 chrome/ <i>kit 3 per decentramento cromato</i>	code	
price VAT excluded			
code	8000152		
price VAT excluded			
accessories	off centre kit 3 chrome/ <i>kit 3 per decentramento cromato</i>	code	
price VAT excluded			
code	8000152		
price VAT excluded			
accessories	off centre kit 3 chrome/ <i>kit 3 per decentramento cromato</i>	code	
price VAT excluded			
code	8000152		
price VAT excluded			
accessories	off centre kit 3 chrome/ <i>kit 3 per decentramento cromato</i>	code	
price VAT excluded			
code	8000152		
price VAT excluded			
accessories	off centre kit 3 chrome/ <i>kit 3 per decentramento cromato</i>	code	
price VAT excluded			
code	8000152		
price VAT excluded			
accessories	off centre kit 3 chrome/ <i>kit 3 per decentramento cromato</i>	code	
price VAT excluded			
code	8000152		
price VAT excluded			
accessories	off centre kit 3 chrome/ <i>kit 3 per decentramento cromato</i>	code	
price VAT excluded			
code	8000152		
price VAT excluded			
accessories	off centre kit 3 chrome/ <i>kit 3 per decentramento cromato</i>	code	
price VAT excluded			
code	8000152		
price VAT excluded			
accessories	off centre kit 3 chrome/ <i>kit 3 per decentramento cromato</i>	code	
price VAT excluded			
code	8000152		
price VAT excluded			
accessories	off centre kit 3 chrome/ <i>kit 3 per decentramento cromato</i> </		

FAIRY S S - D3

Toso, Massari & Associates With G. Toso, 2009

DESIGN

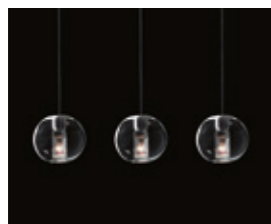
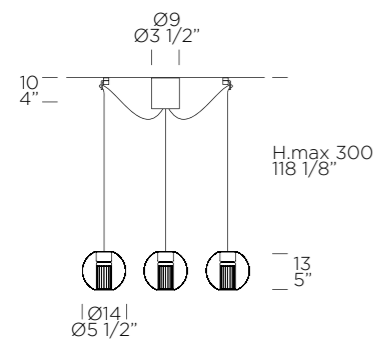

weight-volume 6,21 kg - 0.100 m³



source **GU4** 3x4W Retrofit LED (not included) A+ / B

materials borosilicate glass, metal/*vetro borosilicato, metallo*

structure finish	diffuser finish	code	price VAT excluded
chrome/ <i>cromo lucido</i>	<input type="checkbox"/> transparent/ <i>trasparente</i>	0003278	850,00 €

notes

Dimmable transformer included/*Trasformatore dimmerabile compreso*
Phase cut dimming with dimmable light bulb only/*Dimmerabile a taglio di fase con lampadina compatibile*
Special version upon request. For more details view "SPECIAL VERSIONS" chapter
A richiesta versioni speciali. Per maggiori dettagli vedi capitolo "VERSIONI SPECIALI"
Maximum supported power/*Potenza massima installabile*: GU4 3xMAX 35W Halo (not included)

weight-volume 6,21 kg - 0.100 m³

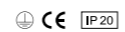

source 3x3,2W **LED** 1230lm 3000K CRI>80 (included - replaceable LED) A++ **LED**

materials borosilicate glass, metal/*vetro borosilicato, metallo*

structure finish	diffuser finish	code	price VAT excluded
chrome/ <i>cromo lucido</i>	<input type="checkbox"/> transparent/ <i>trasparente</i>	0009073	990,00 €

notes

With electronic ballast/*Completa di alimentatore elettronico*
Phase cut dimming/*Dimmerabile a taglio di fase*
Special version upon request. For more details view "SPECIAL VERSIONS" chapter
A richiesta versioni speciali. Per maggiori dettagli vedi capitolo "VERSIONI SPECIALI"

FELIX S 55

Leucos Design Lab, 1996

DESIGN

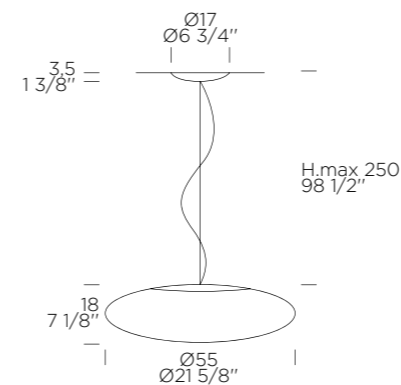

weight-volume 11,4 kg - 0.170 m³



source E27 3x10W Retrofit LED (not included) A+ / E

materials blown glass, metal/*vetro soffiato, metallo*

structure finish	diffuser finish	code	price VAT excluded
grey/ <i>grigio</i>	<input type="checkbox"/> satin white/ <i>bianco satinato</i>	0002287	525,00 €

accessories

off centre kit 1 chrome/ <i>kit 1 per decentramento cromato</i>	8000150	16,00 €
off centre kit 2 chrome/ <i>kit 2 per decentramento cromato</i>	8000135	89,00 €

notes

Maximum supported power/*Potenza massima installabile*: E27 3xMAX 57W Halo (not included)

FELIX S 47

Leucos Design Lab, 1996

DESIGN

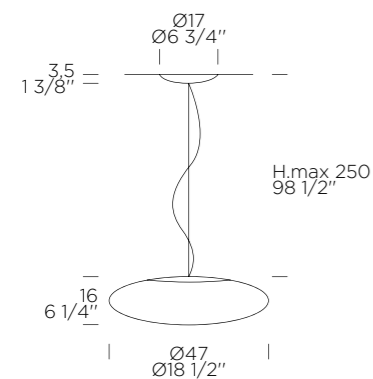

weight-volume 8,8 kg - 0.130 m³

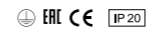

source E27 3x10W Retrofit LED (not included) A+ / E

materials blown glass, metal/*vetro soffiato, metallo*

structure finish	diffuser finish	code	price VAT excluded
grey/ <i>grigio</i>	<input type="checkbox"/> satin white/ <i>bianco satinato</i>	0002277	460,00 €

accessories

off centre kit 1 chrome/ <i>kit 1 per decentramento cromato</i>	8000150	16,00 €
off centre kit 2 chrome/ <i>kit 2 per decentramento cromato</i>	8000135	89,00 €

notes

Maximum supported power/*Potenza massima installabile*: E27 3xMAX 57W Halo (not included)

FLECHA S

Jorge Pensi, 2013

DESIGN

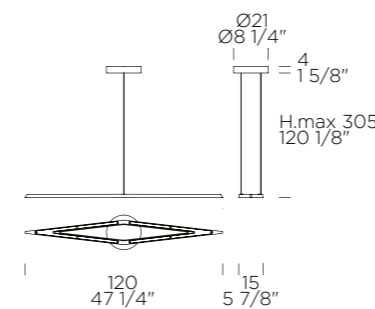

weight-volume 4 kg - 0.100 m³



source 1x34W LED 3000lm 3000K (included) A++ / A **LED**

materials compact polyurethane resin, metal

structure finish	diffuser finish	code	price VAT excluded
gloss white/ <i>bianco lucido</i>	<input type="checkbox"/> gloss white/ <i>bianco lucido</i>	0003583	966,00 €

accessories

dimmer kit AKI/ <i>FLECHA S</i>	8000148	122,00 €
---------------------------------	---------	----------

notes

With electronic ballast/*Alimentatore elettronico incluso*
Kit dimmer accessory: 8-100% dimmable with external button. The latter is not supplied
Accessorio kit dimmer: dimmerabile 8-100% con pulsante esterno. Pulsante esterno non fornito

GLÒ INCASSO I

Daniilo De Rossi, 2002

DESIGN

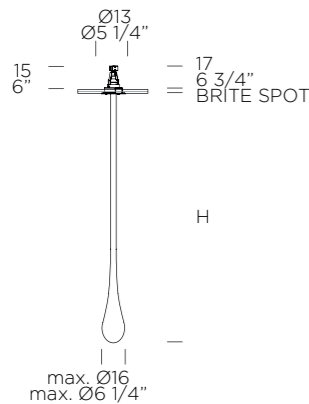

Foro/Opening Ø9,5 - Ø3 3/4



peso-volume 11 kg - 0.250 m³

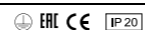

sorgente GU10 1x7W Retrofit LED (not included) A+ / D

materiali blown glass, metal/vetro soffiato, metallo

structure finish	diffuser finish	H	code	price VAT excluded
chrome/cromo lucido	white sfumato/ bianco sfumato	H. 85 cm	0002821	1.024,00 €
chrome/cromo lucido	red/rosso	H. 85 cm	0002824	1.024,00 €
chrome/cromo lucido	aquamarine/ acquamarina	H. 85 cm	0002827	1.024,00 €
chrome/cromo lucido	white sfumato/ bianco sfumato	H. 150 cm	0002984	1.335,00 €
chrome/cromo lucido	red/rosso	H. 150 cm	0002988	1.335,00 €
chrome/cromo lucido	aquamarine/ acquamarina	H. 150 cm	0002992	1.335,00 €
chrome/cromo lucido	white sfumato/ bianco sfumato	H. 210cm	0002904	1.581,00 €
chrome/cromo lucido	red/rosso	H. 210cm	0002907	1.581,00 €
chrome/cromo lucido	aquamarine/ acquamarina	H. 210cm	0002910	1.581,00 €
chrome/cromo lucido	white sfumato/ bianco sfumato	H. 270 cm	0002928	1.581,00 €
chrome/cromo lucido	red/rosso	H. 270 cm	0002932	1.581,00 €
chrome/cromo lucido	aquamarine/ acquamarina	H. 270 cm	0002936	1.581,00 €

notes

Poured glass spot provided/Con macchia compressa
The weight can vary according to the thickness of the glass/
Il peso è indicativo e può variare in funzione dello spessore del vetro
The size of the drop diameter varies in proportion to the product height (max. Ø16 cm)/
Dimensione diametro goccia variabile proporzionalmente all'altezza del prodotto (max Ø 16 cm)
Special version upon request. For more details view "SPECIAL VERSIONS" chapter
A richiesta versioni speciali. Per maggiori dettagli vedi capitolo "VERSIONI SPECIALI"
Supplied with GU10 1x42W Halo bulb/Fornita con lampadina GU10 1x42W Alogena
Maximum supported power/Potenza massima installabile: GU10 1xMAX 50W Halo (not included)

GLÒ S

Daniilo De Rossi, 2010

DESIGN

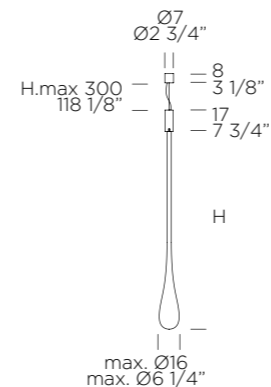

weight-volume 11,4 kg - 0.270 m³



source GU10 1x7W Retrofit LED (not included) A+ / D

materiali blown glass, metal/vetro soffiato, metallo

structure finish	diffuser finish	H	code	price VAT excluded
chrome/cromo lucido	white sfumato/ bianco sfumato	H. 85 cm	0003114	1.057,00 €
chrome/cromo lucido	red/rosso	H. 85 cm	0003116	1.057,00 €
chrome/cromo lucido	aquamarine/ acquamarina	H. 85 cm	0003118	1.057,00 €
chrome/cromo lucido	white sfumato/ bianco sfumato	H. 150 cm	0003159	1.376,00 €
chrome/cromo lucido	red/rosso	H. 150 cm	0003162	1.376,00 €
chrome/cromo lucido	aquamarine/ acquamarina	H. 150 cm	0003165	1.376,00 €
chrome/cromo lucido	white sfumato/ bianco sfumato	H. 210 cm	0003187	1.663,00 €
chrome/cromo lucido	red/rosso	H. 210 cm	0003189	1.663,00 €
chrome/cromo lucido	aquamarine/ acquamarina	H. 210 cm	0003191	1.663,00 €
chrome/cromo lucido	white sfumato/ bianco sfumato	H. 270 cm	0003400	1.663,00 €
chrome/cromo lucido	red/rosso	H. 270 cm	0003403	1.663,00 €
chrome/cromo lucido	aquamarine/ acquamarina	H. 270 cm	0003406	1.663,00 €

notes

Poured glass spot provided/Con macchia compressa
The weight can vary according to the thickness of the glass/
Il peso è indicativo e può variare in funzione dello spessore del vetro
The size of the drop diameter varies in proportion to the product height (max. Ø16 cm)/
Dimensione diametro goccia variabile proporzionalmente all'altezza del prodotto (max Ø 16 cm)
Special version upon request. For more details view "SPECIAL VERSIONS" chapter
A richiesta versioni speciali. Per maggiori dettagli vedi capitolo "VERSIONI SPECIALI"
Supplied with GU10 1x42W Halo bulb/Fornita con lampadina GU10 1x42W Alogena
Maximum supported power/Potenza massima installabile: GU10 1xMAX 50W Halo (not included)

GLÒ PLAFONIERA PL

Daniilo De Rossi, 2002

DESIGN

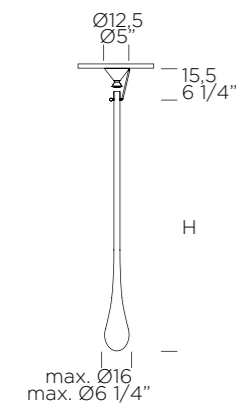

weight-volume 11,1 kg - 0.250 m³



source GU10 1x7W Retrofit LED (not included) A+ / D

materiali blown glass, metal/vetro soffiato, metallo

structure finish	diffuser finish	H	code	price VAT excluded
chrome/cromo lucido	white sfumato/ bianco sfumato	H. 102 cm	0003646	1.032,00 €
chrome/cromo lucido	red/rosso	H. 102 cm	0003648	1.032,00 €
chrome/cromo lucido	aquamarine/ acquamarina	H. 102 cm	0003650	1.032,00 €
chrome/cromo lucido	white sfumato/ bianco sfumato	H. 167 cm	0003670	1.589,00 €
chrome/cromo lucido	red/rosso	H. 167 cm	0003672	1.589,00 €
chrome/cromo lucido	aquamarine/ acquamarina	H. 167 cm	0003674	1.589,00 €
chrome/cromo lucido	white sfumato/ bianco sfumato	H. 227 cm	0003694	1.589,00 €
chrome/cromo lucido	red/rosso	H. 227 cm	0003696	1.589,00 €
chrome/cromo lucido	aquamarine/ acquamarina	H. 227 cm	0003698	1.589,00 €
chrome/cromo lucido	white sfumato/ bianco sfumato	H. 287 cm	0003718	1.589,00 €
chrome/cromo lucido	red/rosso	H. 287 cm	0003720	1.589,00 €
chrome/cromo lucido	aquamarine/ acquamarina	H. 287 cm	0003722	1.589,00 €

notes

Poured glass spot provided/Con macchia compressa
The weight can vary according to the thickness of the glass/
Il peso è indicativo e può variare in funzione dello spessore del vetro
The size of the drop diameter varies in proportion to the product height (max. Ø16 cm)/
Dimensione diametro goccia variabile proporzionalmente all'altezza del prodotto (max Ø 16 cm)
Special version upon request. For more details view "SPECIAL VERSIONS" chapter
A richiesta versioni speciali. Per maggiori dettagli vedi capitolo "VERSIONI SPECIALI"
Supplied with GU10 1x42W Halo bulb/Fornita con lampadina GU10 1x42W Alogena
Maximum supported power/Potenza massima installabile: GU10 1xMAX 50W Halo (not included)

GLÒ S/I

Daniilo De Rossi, 2010

DESIGN

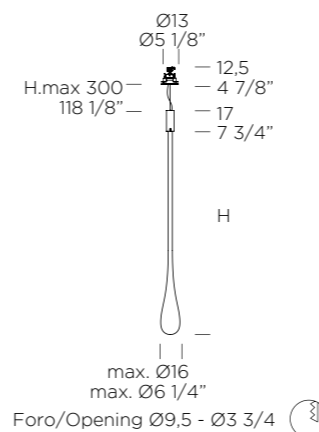

weight-volume 11,4 kg - 0.270 m³



source GU10 1x7W Retrofit LED (not included) A+ / D

materiali blown glass, metal/vetro soffiato, metallo

structure finish	diffuser finish	H	code	price VAT excluded
chrome/cromo lucido	white sfumato/ bianco sfumato	H. 85 cm	0003424	1.106,00 €
chrome/cromo lucido	red/rosso	H. 85 cm	0003427	1.106,00 €
chrome/cromo lucido	aquamarine/ acquamarina	H. 85 cm	0003430	1.106,00 €
chrome/cromo lucido	white sfumato/ bianco sfumato	H. 150 cm	0003460	1.450,00 €
chrome/cromo lucido	red/rosso	H. 150 cm	0003463	1.450,00 €
chrome/cromo lucido	aquamarine/ acquamarina	H. 150 cm	0003466	1.450,00 €
chrome/cromo lucido	white sfumato/ bianco sfumato	H. 210 cm	0003496	1.737,00 €
chrome/cromo lucido	red/rosso	H. 210 cm	0003499	1.737,00 €
chrome/cromo lucido	aquamarine/ acquamarina	H. 210 cm	0003502	1.737,00 €
chrome/cromo lucido	white sfumato/ bianco sfumato	H. 270 cm	0003532	1.737,00 €
chrome/cromo lucido	red/rosso	H. 270 cm	0003535	1.737,00 €
chrome/cromo lucido	aquamarine/ acquamarina	H. 270 cm	0003538	1.737,00 €

notes

Poured glass spot provided/Con macchia compressa
The weight can vary according to the thickness of the glass/
Il peso è indicativo e può variare in funzione dello spessore del vetro
The size of the drop diameter varies in proportion to the product height (max. Ø16 cm)/
Dimensione diametro goccia variabile proporzionalmente all'altezza del prodotto (max Ø 16 cm)
Special version upon request. For more details view "SPECIAL VERSIONS" chapter
A richiesta versioni speciali. Per maggiori dettagli vedi capitolo "VERSIONI SPECIALI"
Supplied with GU10 1x42W Halo bulb/Fornita con lampadina GU10 1x42W Alogena
Maximum supported power/Potenza massima installabile: GU10 1xMAX 50W Halo (not included)

GOLF S 3

Toso & Massari, 1992

DESIGN

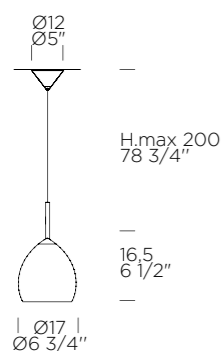

weight-volume 3,28 kg - 0.020 m³



source E27 1x10W Retrofit LED (not included) A+ / E

materials blown glass, metal/vetro soffiato, metallo

structure finish	diffuser finish	code	price VAT excluded
chrome/cromo lucido	satin white/bianco satinato	0003152	294,00 €

accessories
off centre kit 3 chrome/kit 3 per decentramento cromato 8000152 16,00 €

notes
Maximum supported power/Potenza massima installabile: E27 1xMAX 150W Halo (not included)

PENDANT
SOSPENSIONE

IXI S

Filippo Caprioglio, 2011

DESIGN

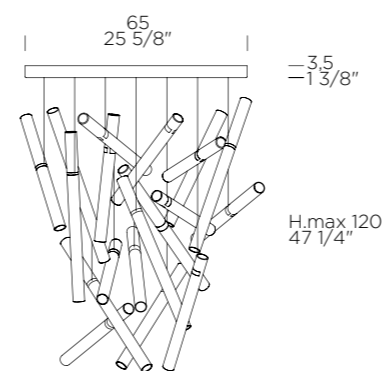

weight-volume 16,8 kg - 0.230 m³



source 5x12W LED 4500lm 3000K (included) A++ / A LED

materials glass, metal/vetro, metallo

structure finish	diffuser finish	code	price VAT excluded
matte white/bianco opaco	transparent/trasparente	0010347	2.171,00 €
matte white/bianco opaco	transparent with mirror chrome details/trasparente con decori metallizzati a specchio	0002293	2.533,00 €

accessories
receiver + remote control kit for LED light sources/kit ricevitore + telecomando per fonti luminose LED 8000143 532,00 €

notes
With electronic ballast/ Completa di alimentatore elettronico
0-100% dimmable with external button (the latter is not supplied)/ Dimmerabile 1-100% con pulsante esterno (pulsante esterno non fornito)
1-10V dimmable/ Dimmerabile 1-10V
Special version upon request. For more details view "SPECIAL VERSIONS" chapter/ A richiesta versioni speciali. Per maggiori dettagli vedi capitolo "VERSIONI SPECIALI"

PENDANT
SOSPENSIONE

GOLF S 3/SP

Toso & Massari, 1992

DESIGN

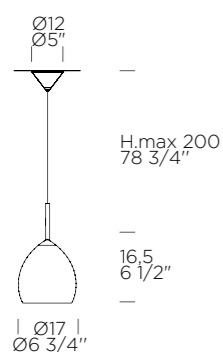

weight-volume 3,58 kg - 0.020 m³



source E27 1x10W Retrofit LED (not included) A+ / E

materials blown glass, metal/vetro soffiato, metallo

structure finish	diffuser finish	code	price VAT excluded
chrome/cromo lucido	chromed/cromatizzato	0003150	401,00 €

accessories
off centre kit 3 chrome/kit 3 per decentramento cromato 8000152 16,00 €

notes
Maximum supported power/Potenza massima installabile: E27 1xMAX 100W Halo (not included)

KEYRA S 30

Roberto Paoli, 2011

DESIGN

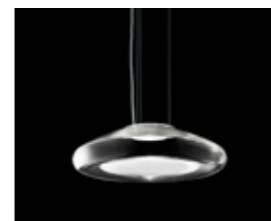
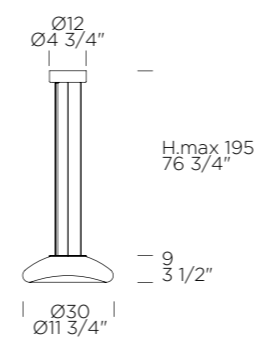

weight-volume 2,8 kg - 0.040 m³



source 1x13W LED 900lm 3000K (included) A++ / A LED

materials blown glass, metal/vetro soffiato, metallo

structure finish	diffuser finish	code	price VAT excluded
gloss white/bianco lucido	transparent-satin white/ trasparente parzialmente decorato	0002304	630,00 €

notes
With electronic ballast/ Completa di alimentatore elettronico

KEYRA S 60

Roberto Paoli, 2011

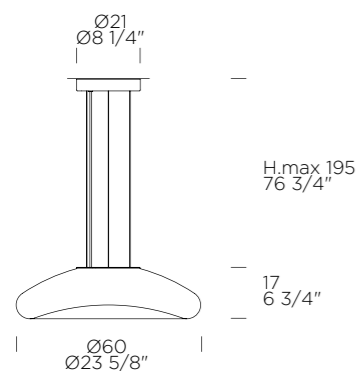
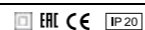
DESIGN**weight-volume** 12,1 kg - 0.160 m³**source** 2x13W LED 1800lm 3000K (included) A++ / A **LED****materials** blown glass, metal/*vetro soffiato, metallo***structure finish**gloss white/*bianco lucido***diffuser finish**transparent-satin white/*trasparente parzialmente decorato***code**

0002306

price VAT excluded

1.171,00 €

notesWith electronic ballast/*Completa di alimentatore elettronico***KUK S**

Paolo Crepax, 2011

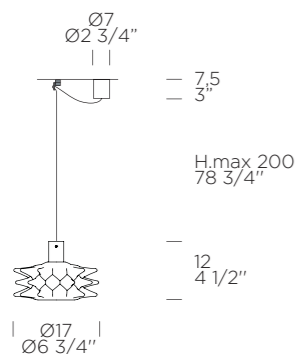
DESIGN**weight-volume** 2,98 kg - 0.020 m³**source** G9 1x3W Retrofit LED (not included) A+ / D**materials** handmade glass, metal/*vetro lavorato a mano, metallo***structure finish**chrome/*cromo lucido***diffuser finish**transparent/*trasparente***code**

0003335

price VAT excluded

417,00 €

notesMaximum supported power/*Potenza massima installabile*: G9 1xMAX 48W Halo (not included)**LILITH S 40**

Leucos Design Lab, 2005

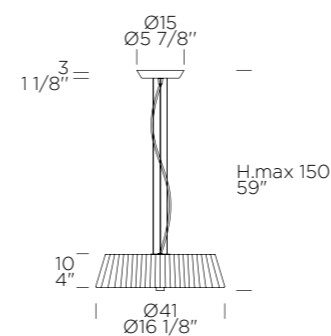
DESIGN**weight-volume** 4,5 kg - 0.050 m³**source** E14 3x5W Retrofit LED (not included) A+ / E**materials** cotton thread, nickel/*filo di cotone, nichel***structure finish**brushed nickel/*nichel spazzolato*brushed nickel/*nichel spazzolato*brushed nickel/*nichel spazzolato***diffuser finish**silver/*argento*white/*bianco*mocha/*moka***code**

0000083

0000089

0000106

price VAT excluded

188,00 €

188,00 €

188,00 €

notesMaximum supported power/*Potenza massima installabile*: E14 3xMAX 46W Halo (not included)**LILITH S 55**

Leucos Design Lab, 2005

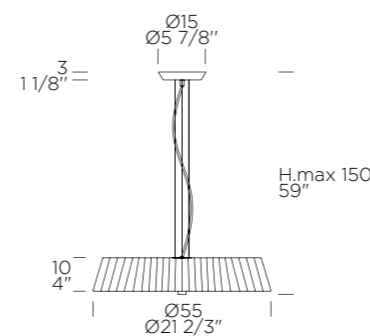
DESIGN**weight-volume** 6,8 kg - 0.090 m³**source** E27 4x10W Retrofit LED (not included) A+ / E**materials** cotton thread, nickel/*filo di cotone, nichel***structure finish**brushed nickel/*nichel spazzolato*brushed nickel/*nichel spazzolato*brushed nickel/*nichel spazzolato***diffuser finish**silver/*argento*white/*bianco*mocha/*moka***code**

0000084

0000090

0000107

price VAT excluded

253,00 €

253,00 €

253,00 €

notesMaximum supported power/*Potenza massima installabile*: E27 4xMAX 57W Halo (not included)**LILITH S 70**

Leucos Design Lab, 2005

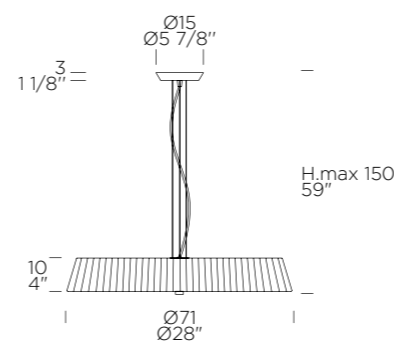
DESIGN**weight-volume** 8,4 kg - 0.150 m³**source** E27 6x10W Retrofit LED (not included) A+ / E**materials** cotton thread, nickel/*filo di cotone, nichel***structure finish**brushed nickel/*nichel spazzolato*brushed nickel/*nichel spazzolato*brushed nickel/*nichel spazzolato***diffuser finish**silver/*argento*white/*bianco*mocha/*moka***code**

0000121

0000125

0000136

price VAT excluded

294,00 €

294,00 €

294,00 €

notesMaximum supported power/*Potenza massima installabile*: E27 6xMAX 57W Halo (not included)

MERCURE S

Patrick Jouin, 2008

DESIGN

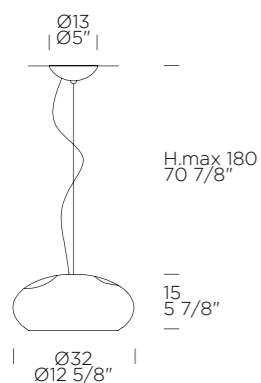

weight-volume 2 kg - 0.040 m³



source E14 1x5W Retrofit LED (not included) A+ / E

materials blown glass, metal/*vetro soffiato, metallo*

structure finish	diffuser finish	code	price VAT excluded
chrome/ <i>romo lucido</i>	pulegoso/mirrored <i>trasparente pulegoso a specchio</i>	0002302	573,00 €

accessories

off centre kit 1 chrome/ <i>kit 1 per decentramento cromato</i>	8000150	16,00 €
off centre kit 2 chrome/ <i>kit 2 per decentramento cromato</i>	8000135	89,00 €

notes

Maximum supported power/*Potenza massima installabile*: E14 1xMAX 46W Halo (not included)

MODULO S 35

Toso, Massari & Associates, 1998

DESIGN

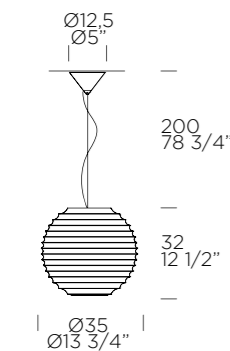

weight-volume 5,9 kg - 0.150 m³



source E27 1x15W Retrofit LED (not included) A+ / E

materials blown glass, metal

structure finish	diffuser finish	code	price VAT excluded
brushed nickel/ <i>nichel spazzolato</i>	gloss white/ <i>bianco lucido</i>	0003221	417,00 €

accessories

off centre kit 4 brushed nickel	8000155	24,00 €
---------------------------------	---------	---------

notes

Maximum supported power/*Potenza massima installabile*: E27 1xMAX 150W Halo (not included)

MYSTÈS S

Roberto Paoli, 2018

DESIGN

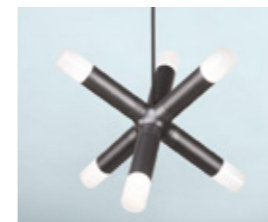
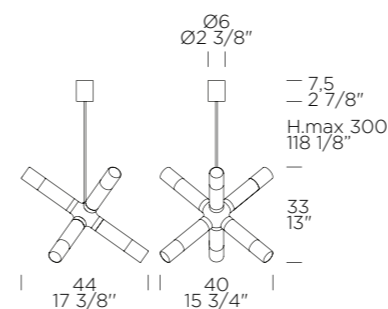

weight-volume 6,8 kg - 0.220 m³



source E14 6x5W Retrofit LED (not included) A++ / B

materials metal, borosilicate glass/*metallo, vetro borosilicato*

structure finish	diffuser finish	code	price VAT excluded
anthracite with black cable/ <i>antracite con cavo nero</i>	sandblasted borosilicate/ <i>borosilicato sabbiato</i>	0010291	966,00 €
white RAL 9010 with red cable/ <i>bianco RAL 9010 con cavo rosso</i>	sandblasted borosilicate/ <i>borosilicato sabbiato</i>	0010295	942,00 €
"cappadocia" gold with black cable/ <i>oro cappadocia con cavo nero</i>	sandblasted borosilicate/ <i>borosilicato sabbiato</i>	0010297	966,00 €

notes

Textile cable/*Cavo in tessuto*

Clear glass available on request/*Versione con vetri trasparenti disponibile su richiesta*

Custom colors on request/*Colori personalizzati su richiesta*

Maximum supported power/*Potenza massima installabile*: E14 6xMAX 8W Retrofit LED (not included)

Phase cut dimming with dimmable light bulb only/*Dimmerabile a taglio di fase con lampadina compatibile*

NIA S

Roberto Paoli, 2012

DESIGN

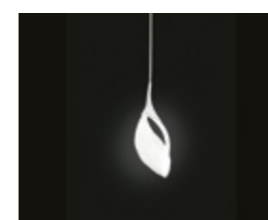
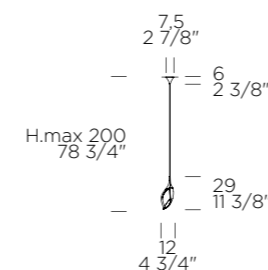

weight-volume 1,1 kg - 0.010 m³



source 1x2,6W LED 290lm **3000K** CRI>90 (included - replaceable LED) A++ / A **LED**

materials handmade cast glass, metal and polycarbonate/
vetro colato lavorato a mano, metallo e policarbonato

structure finish	diffuser finish	code	price VAT excluded
matte white/ <i>bianco opaco</i>	transparent silky white/ <i>trasparente retroverniciato bianco seta</i>	0004447	163,00 €

accessories

electronic ballast 4,2W 24VDC/ <i>alimentatore elettronico 4,2W 24VDC</i>	8000145	40,00 €
white canopy ø10 cm for 1 NIA/ <i>rosone ø10 cm x 1 calata NIA bianco</i>	8000144	98,00 €

notes

Dimmable version available on demand/*Versione dimmerabile su richiesta*

Electric ballast not included in the mentioned price/*Alimentatore elettronico non compreso nel prezzo*

Special version upon request. For more details view "SPECIAL VERSIONS" chapter/
A richiesta versioni speciali. Per maggiori dettagli vedi capitolo "VERSIONI SPECIALI"

weight-volume 1,1 kg - 0.010 m³



source 1x2,6W LED 280lm **2700K** CRI>90 (included - replaceable LED) A++ / A **LED**

materials handmade cast glass, metal and polycarbonate/
vetro colato lavorato a mano, metallo e policarbonato

structure finish	diffuser finish	code	price VAT excluded
matte white/ <i>bianco opaco</i>	transparent silky white/ <i>trasparente retroverniciato bianco seta</i>	0004405	163,00 €

accessories

electronic ballast 4,2W 24VDC/ <i>alimentatore elettronico 4,2W 24VDC</i>	8000145	40,00 €
white canopy ø10 cm for NIA S/ <i>rosone ø10 cm x 1 calata NIA bianco</i>	8000144	98,00 €

notes

Dimmable version available on demand/*Versione dimmerabile su richiesta*

Electric ballast not included in the mentioned price/*Alimentatore elettronico non compreso nel prezzo*

Special version upon request. For more details view "SPECIAL VERSIONS" chapter/
A richiesta versioni speciali. Per maggiori dettagli vedi capitolo "VERSIONI SPECIALI"

NIA S 3

Roberto Paoli, 2012

DESIGN

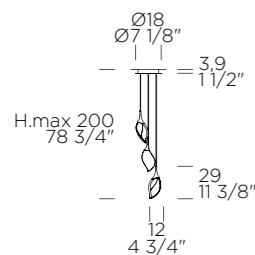

weight-volume 4,2 kg - 0.020 m³

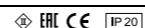

source 3x2,6W LED 870lm **3000K** CRI>90 (included - replaceable LED) A++ / A **LED**

materials handmade cast glass, metal and polycarbonate/
vetro colato lavorato a mano, metallo e policarbonato

structure finish	diffuser finish	code	price VAT excluded
matte white/ <i>bianco opaco</i>	transparent silky whitetransparent silky white/ <i>trasparente retroverniciato bianco seta</i>	0004444	565,00 €

accessories electronic ballast 20W 24VDC/*alimentatore elettronico 20W 24VDC* 8000146 57,00 €

notes

Dimmable version available on demand/*Versione dimmerabile su richiesta*
Electric ballast not included in the mentioned price/*Alimentatore elettronico non compreso nel prezzo*
Special version upon request. For more details view "SPECIAL VERSIONS" chapter/*A richiesta versioni speciali. Per maggiori dettagli vedi capitolo "VERSIONI SPECIALI"*

weight-volume 4,2 kg - 0.020 m³



source 3x2,6W LED 840lm **2700K** CRI>90 (included - replaceable LED) A++ / A **LED**

materials handmade cast glass, metal and polycarbonate/
vetro colato lavorato a mano, metallo e policarbonato

structure finish	diffuser finish	code	price VAT excluded
matte white/ <i>bianco opaco</i>	transparent silky white/ <i>trasparente retroverniciato bianco seta</i>	0004402	565,00 €

accessories electronic ballast 20W 24VDC/*alimentatore elettronico 20W 24VDC* 8000146 57,00 €

notes

Dimmable version available on demand/*Versione dimmerabile su richiesta*
Electric ballast not included in the mentioned price/*Alimentatore elettronico non compreso nel prezzo*
Special version upon request. For more details view "SPECIAL VERSIONS" chapter/*A richiesta versioni speciali. Per maggiori dettagli vedi capitolo "VERSIONI SPECIALI"*

NIA S 12

Roberto Paoli, 2012

DESIGN

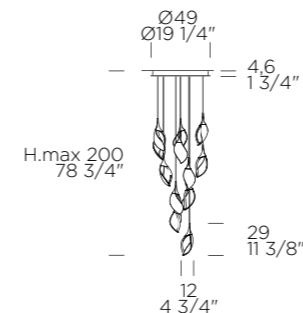

weight-volume 20,2 kg - 0.120 m³



source 12x2,6W LED 3480lm **3000K** CRI>90 (included - replaceable LED) A++ / A **LED**

materials handmade cast glass, metal and polycarbonate/
vetro colato lavorato a mano, metallo e policarbonato

structure finish	diffuser finish	code	price VAT excluded
matte white/ <i>bianco opaco</i>	transparent silky white/ <i>trasparente retroverniciato bianco seta</i>	0004446	1.950,00 €

accessories electronic ballast 60W 24VDC/*alimentatore elettronico 60W 24VDC* 8000147 89,00 €

notes

Dimmable version available on demand/*Versione dimmerabile su richiesta*
Electric ballast not included in the mentioned price/*Alimentatore elettronico non compreso nel prezzo*
Special version upon request. For more details view "SPECIAL VERSIONS" chapter/*A richiesta versioni speciali. Per maggiori dettagli vedi capitolo "VERSIONI SPECIALI"*

weight-volume 20,2 kg - 0.120 m³



source 12x2,6W LED 3360lm **2700K** CRI>90 (included - replaceable LED) A++ / A **LED**

materials handmade cast glass, metal and polycarbonate/
vetro colato lavorato a mano, metallo e policarbonato

structure finish	diffuser finish	code	price VAT excluded
matte white/ <i>bianco opaco</i>	transparent silky white/ <i>trasparente retroverniciato bianco seta</i>	0004404	1.950,00 €

accessories electronic ballast 60W 24VDC/*alimentatore elettronico 60W 24VDC* 8000147 89,00 €

notes

Dimmable version available on demand/*Versione dimmerabile su richiesta*
Electric ballast not included in the mentioned price/*Alimentatore elettronico non compreso nel prezzo*
Special version upon request. For more details view "SPECIAL VERSIONS" chapter/*A richiesta versioni speciali. Per maggiori dettagli vedi capitolo "VERSIONI SPECIALI"*

NIA S 6

Roberto Paoli, 2012

DESIGN

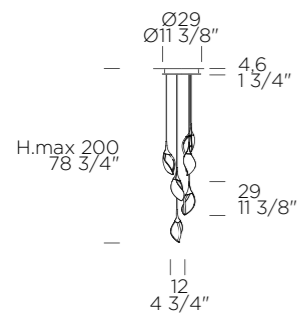

weight-volume 8,4 kg - 0.050 m³



source 6x2,6W LED 1740lm **3000K** CRI>90 (included - replaceable LED) A++ / A **LED**

materials handmade cast glass, metal and polycarbonate/
vetro colato lavorato a mano, metallo e policarbonato

structure finish	diffuser finish	code	price VAT excluded
matte white/ <i>bianco opaco</i>	transparent silky white/ <i>trasparente retroverniciato bianco seta</i>	0004445	1.024,00 €

accessories electronic ballast 20W 24VDC/*alimentatore elettronico 20W 24VDC* 8000146 57,00 €

notes

Dimmable version available on demand/*Versione dimmerabile su richiesta*
Electric ballast not included in the mentioned price/*Alimentatore elettronico non compreso nel prezzo*
Special version upon request. For more details view "SPECIAL VERSIONS" chapter/*A richiesta versioni speciali. Per maggiori dettagli vedi capitolo "VERSIONI SPECIALI"*

weight-volume 8,4 kg - 0.050 m³



source 6x2,6W LED 1680lm **2700K** CRI>90 (included - replaceable LED) A++ / A **LED**

materials handmade cast glass, metal and polycarbonate/
vetro colato lavorato a mano, metallo e policarbonato

structure finish	diffuser finish	code	price VAT excluded
matte white/ <i>bianco opaco</i>	transparent silky white	0004403	1.024,00 €

accessories electronic ballast 20W 24VDC/*alimentatore elettronico 20W 24VDC* 8000146 57,00 €

notes

Dimmable version available on demand/*Versione dimmerabile su richiesta*
Electric ballast not included in the mentioned price/*Alimentatore elettronico non compreso nel prezzo*
Special version upon request. For more details view "SPECIAL VERSIONS" chapter/*A richiesta versioni speciali. Per maggiori dettagli vedi capitolo "VERSIONI SPECIALI"*

ORLEANS L 12

Marina Toscano, 2007

TRADITIONAL

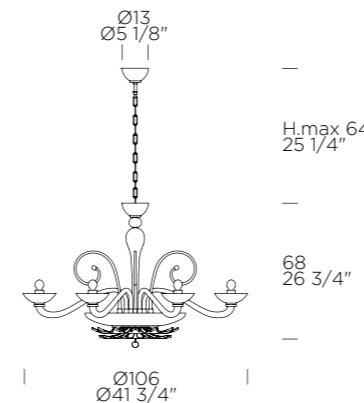

weight-volume 19,6 kg - 0.220 m³



source E14 12x5W Retrofit LED (not included) A+ / E

materials handmade blown glass, metal/*vetro soffiato lavorato a mano, metallo*

structure finish	diffuser finish	code	price VAT excluded
chrome/ <i> Cromo lucido</i>	white-crystal <i>bianco e cristallo</i>	0000735	2.451,00 €
chrome/ <i> Cromo lucido</i>	black-crystal/ <i>nero e cristallo</i>	0000737	2.451,00 €

notes

Free supplied chromed metal chain for extension (60cm)/
Fornita di serie con catena in metallo cromato per allungamento (60cm)
Maximum supported power/*Potenza massima installabile*: E14 12xMAX 46W Halo (not included)

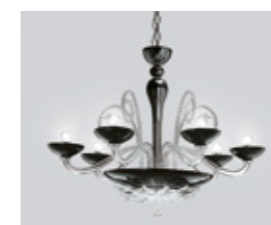

REED S 90

Patrick Jouin, 2009

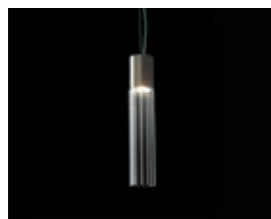
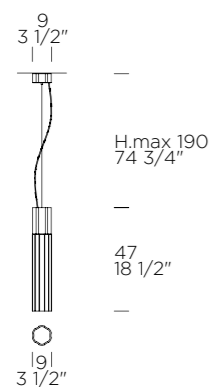
DESIGN**weight-volume** 3,1 kg - 0.030 m³

EBC CE IP20

source GU10 1x7W Retrofit LED (not included) A+ / B**materials** handmade blown glass, aluminium/*vetro soffiato lavorato a mano, alluminio*

structure finish	diffuser finish	code	price VAT excluded
<input checked="" type="checkbox"/> lacquered aluminium nickel/ <i>alluminio laccato nichel</i>	<input type="checkbox"/> transparent/ <i>trasparente</i>	0002378	360,00 €

accessories
off centre kit 1 brushed nickel/*kit 1 per decentramento nickel satinato* 8000151 16,00 €**notes**
Special version upon request. For more details view "SPECIAL VERSIONS" chapter/
A richiesta versioni speciali. Per maggiori dettagli vedi capitolo "VERSIONI SPECIALI"
Maximum supported power: GU10 1xMAX 50W Halo (not included)/
*Potenza massima installabile: GU10 1xMAX 50W Alogena (non inclusa)***REED 90
(canopy kit for composition)**

Patrick Jouin, 2009

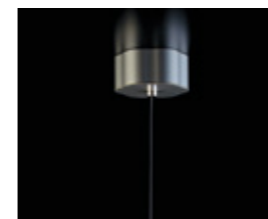
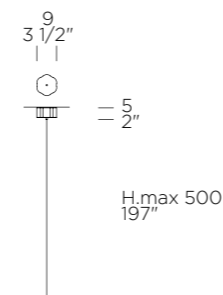
DESIGN**weight-volume** 0,3 kg - 0.010 m³

CE

source**materials** aluminium/*alluminio*

structure finish	diffuser finish	code	price VAT excluded
<input checked="" type="checkbox"/> lacquered aluminium nickel/ <i>alluminio laccato nichel</i>		0002593	114,00 €

notes
For more details view "COMPOSITIONS" chapter
*Per maggiori dettagli vedi capitolo "COMPOSIZIONI"***REED S 135**

Patrick Jouin, 2009

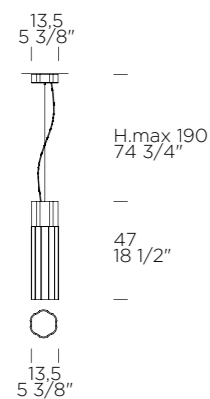
DESIGN**weight-volume** 4,6 kg - 0.030 m³

EBC CE IP20

source GU10 1x7W Retrofit LED (not included) A+ / B**materials** handmade blown glass, aluminium/*vetro soffiato lavorato a mano, alluminio*

structure finish	diffuser finish	code	price VAT excluded
<input checked="" type="checkbox"/> lacquered aluminium nickel/ <i>alluminio laccato nichel</i>	<input type="checkbox"/> transparent/ <i>trasparente</i>	0002380	442,00 €

accessories
off centre kit 1 brushed nickel/*kit 1 per decentramento nickel satinato* 8000151 16,00 €**notes**
Special version upon request. For more details view "SPECIAL VERSIONS" chapter/
A richiesta versioni speciali. Per maggiori dettagli vedi capitolo "VERSIONI SPECIALI"
Maximum supported power: GU10 1xMAX 75W Halo (not included)/
*Potenza massima installabile: GU10 1xMAX 75W Alogena (non inclusa)***REED 135
(canopy kit for composition)**

Patrick Jouin, 2009

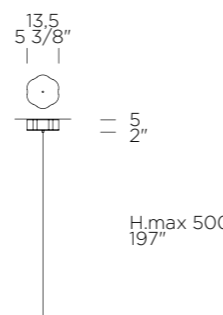
DESIGN**weight-volume** 0,4 kg - 0.010 m³

CE

source**materials** aluminium/*alluminio*

structure finish	diffuser finish	code	price VAT excluded
<input checked="" type="checkbox"/> lacquered aluminium nickel/ <i>alluminio laccato nichel</i>		0002594	116,00 €

notes
For more details view "COMPOSITIONS" chapter
Per maggiori dettagli vedi capitolo "COMPOSIZIONI"

REED 180
(canopy kit for composition)

Patrick Jouin, 2009

DESIGN

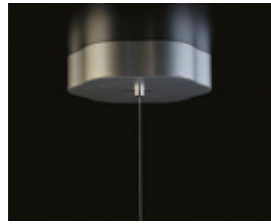
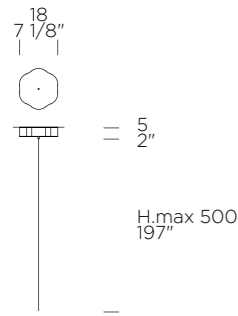

weight-volume	0,5 kg - 0.010 m ³	CE
source		
materials	aluminium/ <i>alluminio</i>	
structure finish	diffuser finish	code
lacquered aluminium nickel/ <i>alluminio laccato nichel</i>		0002595

notes
For more details view "COMPOSITIONS" chapter
Per maggiori dettagli vedi capitolo "COMPOSIZIONI"

price VAT excluded
125,00 €

REED 90 PL - S
(connection kit)

Patrick Jouin, 2009

DESIGN

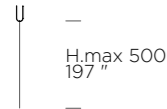

weight-volume	0,25 kg - 0.010 m ³	CE
source		
materials	aluminium/ <i>alluminio</i>	
structure finish	diffuser finish	code
lacquered aluminium nickel/ <i>alluminio laccato nichel</i>		0002588

notes
For more details view "COMPOSITIONS" chapter
Per maggiori dettagli vedi capitolo "COMPOSIZIONI"

price VAT excluded
59,00 €

REED 135 PL - S
(connection kit)

Patrick Jouin, 2009

DESIGN



weight-volume	0,26 kg - 0.010 m ³	CE
source		
materials	aluminium/ <i>alluminio</i>	
structure finish	diffuser finish	code
lacquered aluminium nickel/ <i>alluminio laccato nichel</i>		0002589

notes
For more details view "COMPOSITIONS" chapter
Per maggiori dettagli vedi capitolo "COMPOSIZIONI"

price VAT excluded
65,00 €

REED 90
(glass for composition)

Patrick Jouin, 2009

DESIGN

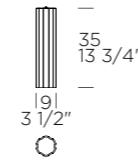

weight-volume	2 kg - 0.020 m ³	CE
source		
materials	handmade blown glass/ <i>vetro soffiato lavorato a mano</i>	
structure finish	diffuser finish	code
polished nickel/ <i>nichel lucido</i>	<input type="checkbox"/> transparent/ <i>trasparente</i>	0002553

notes
For more details view "COMPOSITIONS" chapter
Per maggiori dettagli vedi capitolo "COMPOSIZIONI"

price VAT excluded
196,00 €

REED 135
(glass for composition)

Patrick Jouin, 2009

DESIGN

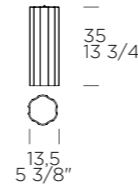

weight-volume	3,1 kg - 0.020 m ³	CE
source		
materials	handmade blown glass/ <i>vetro soffiato lavorato a mano</i>	
structure finish	diffuser finish	code
polished nickel/ <i>nichel lucido</i>	<input type="checkbox"/> transparent/ <i>trasparente</i>	0002554

notes
For more details view "COMPOSITIONS" chapter
Per maggiori dettagli vedi capitolo "COMPOSIZIONI"

price VAT excluded
262,00 €

SERENISSIMA L 6

Leucos Design Lab, 1994

TRADITIONAL

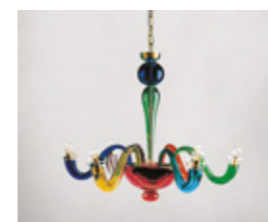
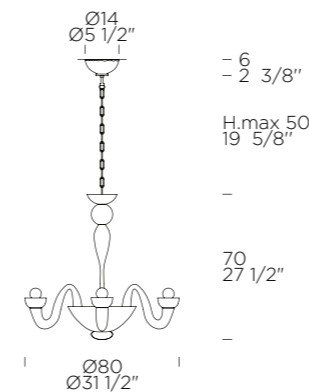

weight-volume	8 kg - 0.300 m ³	EBC CE IP20
source	E14 6x5W Retrofit LED (not included) A+ / E	
materials	handmade blown glass, metal/ <i>vetro soffiato lavorato a mano, metallo</i>	
structure finish	diffuser finish	code
gold/ <i>dorato lucido</i>	multicolor/ <i>multicolore</i>	0000771

notes
Free supplied golden metal chain for extension (50cm)/
Fornita di serie con catena in metallo dorato per allungamento (50cm)
Maximum supported power/*Potenza massima installabile*: E14 6xMAX 46W Halo (not included)

price VAT excluded
4.090,00 €

SERENISSIMA L 12

Leucos Design Lab, 1994

TRADITIONAL

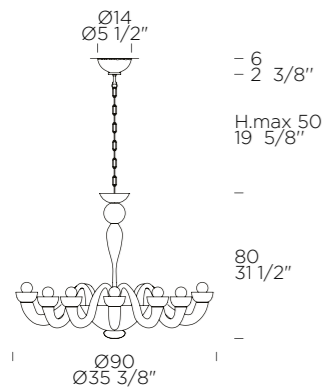

weight-volume 14 kg - 0.390 m³

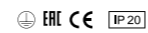

source E14 12x5W Retrofit LED (not included) A+ / E

materials handmade blown glass, metal/*vetro soffiato lavorato a mano, metallo*

structure finish	diffuser finish	code	price VAT excluded
gold/ <i>dorato lucido</i>	multicolor/ <i>multicolore</i>	0000773	7.123,00 €

notes

Free supplied golden metal chain for extension (50cm)/
Fornita di serie con catena in metallo dorato per allungamento (50cm)
 Maximum supported power/*Potenza massima installabile*: E14 12xMAX 46W Halo (not included)

SIBILLA S 40

Crepax & Zanon, 2000

DESIGN

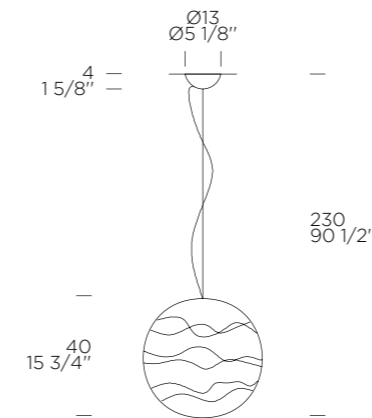

weight-volume 7,8 kg - 0.130 m³



source E27 1x15W Retrofit LED (not included) A+ / E

materials blown glass, metal/*vetro soffiato, metallo*

structure finish	diffuser finish	code	price VAT excluded
chrome/ <i>cromo lucido</i>	transparent/ <i>trasparente</i>	0000145	647,00 €

accessories

off centre kit 1 chrome/ <i>kit 1 per decentramento cromato</i>	8000150	16,00 €
off centre kit 2 chrome/ <i>kit 2 per decentramento cromato</i>	8000135	89,00 €

notes

Maximum supported power/*Potenza massima installabile*: E27 1xMAX 116W Halo (not included)

SIBILLA S 30

Crepax & Zanon, 2000

DESIGN

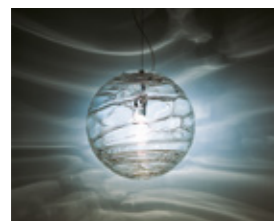
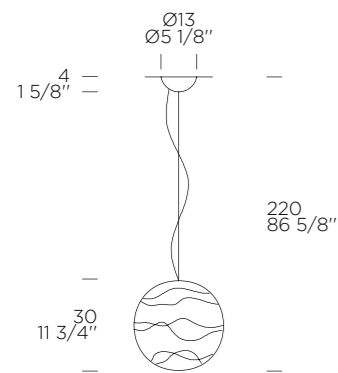

weight-volume 5 kg - 0.070 m³

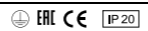

source E27 1x15W Retrofit LED (not included) A+ / E

materials blown glass, metal/*vetro soffiato, metallo*

structure finish	diffuser finish	code	price VAT excluded
chrome/ <i>cromo lucido</i>	transparent/ <i>trasparente</i>	0000070	458,00 €

accessories

off centre kit 1 chrome/ <i>kit 1 per decentramento cromato</i>	8000150	16,00 €
off centre kit 2 chrome/ <i>kit 2 per decentramento cromato</i>	8000135	89,00 €

notes

Maximum supported power/*Potenza massima installabile*: E27 1xMAX 116W Halo (not included)

SPHERA S 29

Matteo Thun, 2000

DESIGN

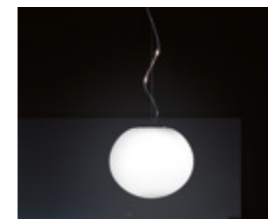
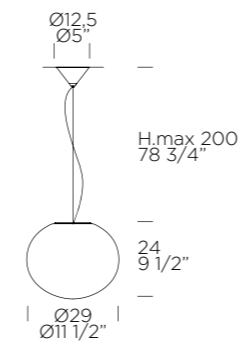

weight-volume 4,4 kg - 0.080 m³



source E27 1x15W Retrofit LED (not included) A+ / E

materials blown glass, metal/*vetro soffiato, metallo*

structure finish	diffuser finish	code	price VAT excluded
chrome/ <i>cromo lucido</i>	satin white/ <i>bianco satinato</i>	0003241	319,00 €

accessories

off centre kit 4 chrome/ <i>kit 4 per decentramento cromato</i>	8000154	24,00 €
---	---------	---------

notes

Maximum supported power/*Potenza massima installabile*: E27 1xMAX 100W Halo (not included)

SPHERA S 37

Matteo Thun, 2000

DESIGN

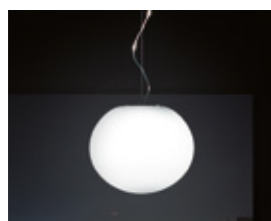
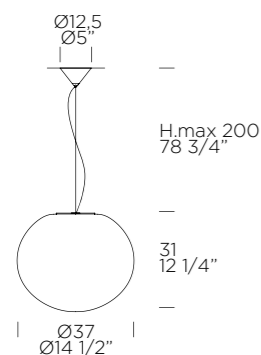

weight-volume 6,2 kg - 0.150 m³

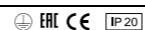

source E27 1x15W Retrofit LED (not included) A+ / E

materials blown glass, metal/*vetro soffiato, metallo*

structure finish	diffuser finish	code	price VAT excluded
chrome/ <i>cromo lucido</i>	satin white/ <i>bianco satinato</i>	0003243	349,00 €

accessories
off centre kit 4 chrome/*kit 4 per decentramento cromato* 8000154 24,00 €

notes
Maximum supported power/*Potenza massima installabile*: E27 1xMAX 150W Halo (not included)

SPORE S

Massimo Iosa Ghini, 2009

DESIGN

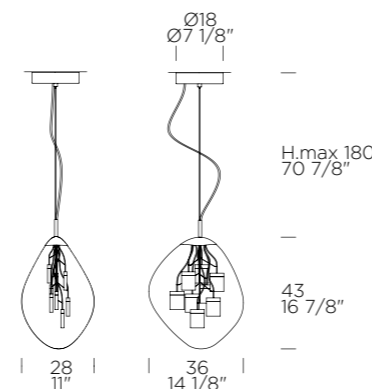

weight-volume 7,4 kg - 0.160 m³



source 8x3W LED 1700lm 3000K (included) A++ / A LED

materials blown glass, metal/*vetro soffiato, metallo*

structure finish	diffuser finish	code	price VAT excluded
chrome/ <i>cromo lucido</i>	transparent/ <i>trasparente</i>	0002330	2.123,00 €

notes
Dimmable version available on demand/*Versione dimmerabile su richiesta*

SPHERA S 45

Matteo Thun, 2000

DESIGN

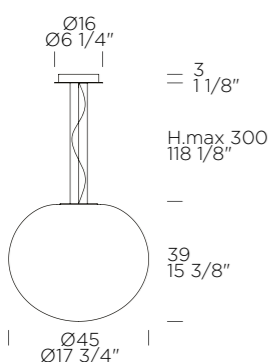

weight-volume 7,8 kg - 0.130 m³



source E27 1x15W Retrofit LED (not included) A+ / E

materials blown glass, metal/*vetro soffiato, metallo*

structure finish	diffuser finish	code	price VAT excluded
chrome/ <i>cromo lucido</i>	satin white/ <i>bianco satinato</i>	0003613	459,00 €

notes
Maximum supported power/*Potenza massima installabile*: E27 1xMAX 150W Halo (not included)

SPRING S

Eva Zeisel, 2012

DESIGN

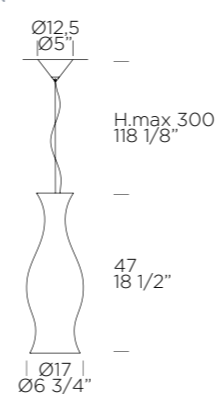

weight-volume 2,9 kg - 0.060 m³

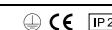

source E27 1x10W Retrofit LED (not included) A+ / E

materials blown glass, metal/*vetro soffiato, metallo*

structure finish	diffuser finish	code	price VAT excluded
chrome/ <i>cromo lucido</i>	gloss white/ <i>bianco lucido</i>	0004290	573,00 €
chrome/ <i>cromo lucido</i>	gloss honey/ <i>giallo paglierino</i>	0004291	573,00 €

accessories
off centre kit 4 chrome/*kit 4 per decentramento cromato* 8000154 24,00 €

notes
Maximum supported power/*Potenza massima installabile*: E27 1xMAX 57W Halo (not included)

SUMMER S

Eva Zeisel, 2012

DESIGN

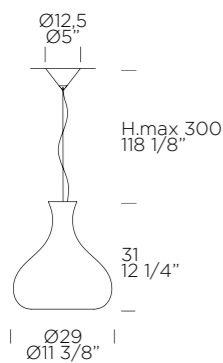

weight-volume 3,8 kg - 0.070 m³

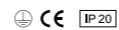

source E27 1x10W Retrofit LED 1000lm (not included) A+ / E

materials blown glass, metal

structure finish	diffuser finish	code	price VAT excluded
chrome/cromo lucido	gloss white/bianco lucido	0004284	606,00 €
chrome/cromo lucido	gloss honey/giallo paglierino	0004285	606,00 €

accessories

off centre kit 4 chrome/kit 4 per decentramento cromato 8000154 24,00 €

notes

Maximum supported power/Potenza massima installabile: E27 1xMAX 57W Halo (not included)

THE GREAT JJ S

Leucos Design Lab, 2006

DESIGN

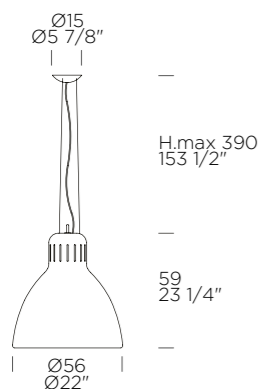

weight-volume 7,5 kg - 0.360 m³



source E27 1x15W Retrofit LED 1500lm (not included) A+ / E

materials aluminium/alluminio

structure finish	diffuser finish	code	price VAT excluded
gloss white/bianco lucido	gloss white/bianco lucido	0001544	1.393,00 €
matte white/ bianco opaco	matte white/bianco opaco	0001533	1.393,00 €
gloss black/nero lucido	gloss black/nero lucido	0001547	1.393,00 €
matte black/nero opaco	matte black/nero opaco	0001539	1.393,00 €

notes

Maximum supported power/Potenza massima installabile: E27 1xMAX 205W Halo (not included)

TRIGONA S

Daniilo De Rossi, 2015

DESIGN

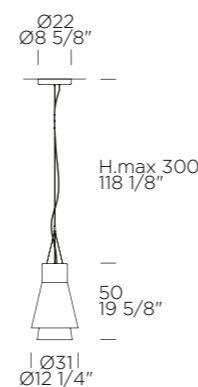

weight-volume 9,8 kg - 0.290 m³

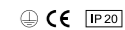

source 1x15W LED 1650lm 2700K CRI 80 (included) A++ / A LED

+ 1x9W LED 810lm 2700K CRI 80 (included)

+ 1x6W LED 610lm 2700K CRI 80 (included)

materials blown borosilicate glass, metal/vetro borosilicato soffiato, metallo

structure finish	diffuser finish	code	price VAT excluded
chrome/cromo lucido	white sfumato-gold/ bianco sfumato e oro	0003622	2.150,00 €
chrome/cromo lucido	white sfumato-titanium grey/ bianco sfumato e grigio titanio	0003623	2.150,00 €
chrome/cromo lucido	black sfumato-gold/ nero sfumato e oro	0004433	2.150,00 €
chrome/cromo lucido	black sfumato-titanium grey/ nero sfumato e grigio titanio	0004434	2.150,00 €

notes

DALI dimmable/Dimmerabile DALI

Double dimmer 15W-9W + 6W/Doppia dimmerazione 15W-9W + 6W

Double switch 15W/9W + 6W/Doppia accensione 15W/9W + 6W

1-10V dimmable/Dimmerabile 1-10V

0-100% dimmable with external button (the latter is not supplied)

Dimmerabile 0-100% con pulsante esterno (pulsante esterno non fornito)

VOLTA S 120

From, 2015

DESIGN

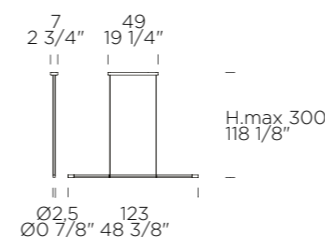

weight-volume 2 kg - 0.020 m³



source 1x23W LED 1950lm 2700K CRI>90 (included) A++ / A LED

materials aluminium, methacrylate (PMMA)/alluminio, metacrilato (PMMA)

structure finish	diffuser finish	code	price VAT excluded
matte white/bianco opaco	satin methacrylate/ metacrilato satinato	0004436	960,00 €
chrome/cromo lucido	satin methacrylate/ metacrilato satinato	0008556	1.190,00 €
textured black RAL 9004/ nero raggrizzante opaco RAL 9004	satin methacrylate/ metacrilato satinato	0008311	1.090,00 €

notes

Touch dimmer 5-100%

Patented hanging system: 360° rotation/Sistema di sospensione brevettato: rotazione 360°

Cable Insulation Kit included/Kit isolamento cavo incluso

VOLTA S 160

From, 2015

DESIGN

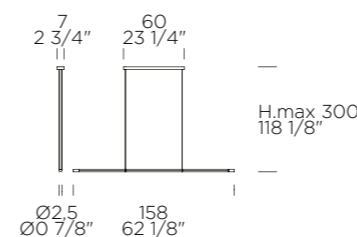

weight-volume 2,4 kg - 0.020 m³



source 1x30W LED 2560lm 2700K CRI>90 (included) A++ / A LED

materials aluminium, methacrylate (PMMA)/alluminio, metacrilato (PMMA)

structure finish	diffuser finish	code	price VAT excluded
matte white/bianco opaco	satin methacrylate/ metacrilato satinato	0004437	1.060,00 €
chrome/cromo lucido	satin methacrylate/ metacrilato satinato	0008557	1.390,00 €
textured black RAL 9004/ nero raggrizzante opaco RAL 9004	satin methacrylate/ metacrilato satinato	0008315	1.190,00 €

notes

Touch dimmer 5-100%

Patented hanging system: 360° rotation/Sistema di sospensione brevettato: rotazione 360°

Cable Insulation Kit included/Kit isolamento cavo incluso

WITCH S

Marco Piva, 2011

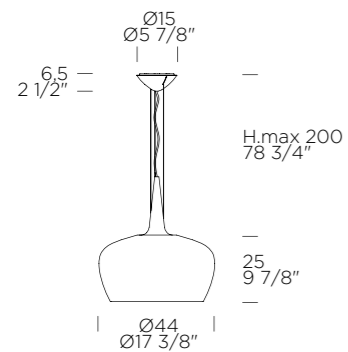
DESIGN**weight-volume** 8,8 kg - 0.160 m³**source** E27 1x10W Retrofit LED (not included) A+ / E**materials** blown glass, metal/*vetro soffiato, metallo***structure finish****diffuser finish****code****price VAT excluded**

<input checked="" type="checkbox"/>	chrome/ <i>cromo lucido</i>	<input type="checkbox"/>	gloss white/ <i>bianco lucido</i>	0003313	692,00 €
<input checked="" type="checkbox"/>	gloss black/ <i>nero lucido</i>	<input checked="" type="checkbox"/>	transparent black/ <i>nero trasparente</i>	0003315	761,00 €

notesMaximum supported power/*Potenza massima installabile*: E27 1xMAX 205W Halo (not included)**3517 S 1**

Leucos Design Lab, 1992

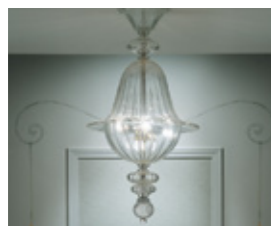
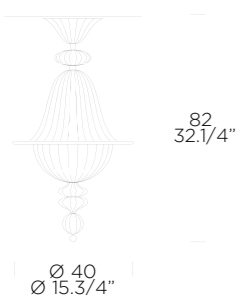
TRADITIONAL**weight-volume** 13,20 kg - 0.190 m³**source** E14 4x5W Retrofit LED (not included) A+ / E**materials** blown glass, metal/*vetro soffiato, metallo***structure finish****diffuser finish****code****price VAT excluded**

<input checked="" type="checkbox"/>	gold/ <i>dorato lucido</i>	<input type="checkbox"/>	transparent/ <i>trasparente</i>	0000660	2.211,00 €
-------------------------------------	----------------------------	--------------------------	---------------------------------	---------	------------

noteMaximum supported power/*Potenza massima installabile*: E14 4xMAX 46W Halo (not included)**3517 S 2**

Leucos Design Lab, 1992

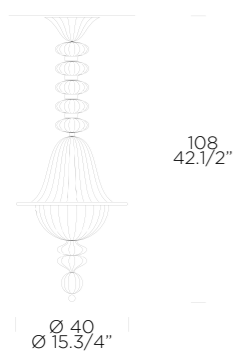
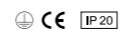
TRADITIONAL**weight-volume** 8,8 kg - 0.160 m³**source** E14 4x5W Retrofit LED (not included) A+ / E**materials** blown glass, metal/*vetro soffiato, metallo***structure finish****diffuser finish****code****price VAT excluded**

<input checked="" type="checkbox"/>	gold/ <i>dorato lucido</i>	<input type="checkbox"/>	transparent/ <i>trasparente</i>	0000747	2.740,00 €
-------------------------------------	----------------------------	--------------------------	---------------------------------	---------	------------

noteMaximum supported power/*Potenza massima installabile*: E14 4xMAX 46W Halo (not included)

WALL
PARETE



AA
pag. 84
DESIGN



ABBEY
pag. 84
DESIGN



ALA
pag. 85
DESIGN



ALIAS
pag. 85
DESIGN



ATELIER
pag. 86
TRADITIONAL



BLOCK
pag. 86
DESIGN



BOLERO
pag. 88
TRADITIONAL



CELINE
pag. 88
DESIGN



CLASS
pag. 89
DESIGN



GOLF
pag. 89
DESIGN



LILITH
pag. 90
DESIGN



LINK
pag. 90
DESIGN



MODULO
pag. 90
DESIGN



OPI
pag. 91
DESIGN



ORLEANS
pag. 91
TRADITIONAL



PASCALE
pag. 91
TRADITIONAL



PUCK
pag. 92
DESIGN



SERENISSIMA
pag. 92
TRADITIONAL



SPRING
pag. 92
DESIGN



SUMMER
pag. 93
DESIGN



VITTORIA
pag. 93
ICON



649
pag. 93
TRADITIONAL

AA P 12

Leucos Design Lab, 2002

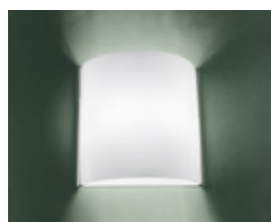
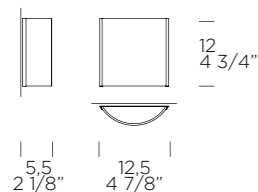
DESIGN**weight-volume** 1 kg - 0.010 m³**source** G9 1x3W Retrofit LED (not included) A+ / D**materials** blown and layered glass, brushed steel/*vetro soffiato e incamiciato, acciaio spazzolato***structure finish**

	brushed steel/ acciaio spazzolato
--	--------------------------------------

diffuser finish

	white/bianco
--	--------------

code

0001883

price VAT excluded

81,00 €

notesPolish finish diffuser/*Finitura diffusore lucida*Maximum supported power/*Potenza massima installabile*: G9 1xMAX 60W Halo (not included)Supplied with bulb 1x48W G9/*Fornita con lampadina 1x48W G9***AA P 20**

Leucos Design Lab, 2002

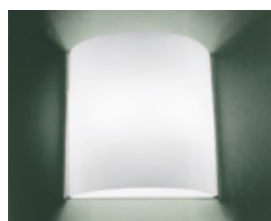
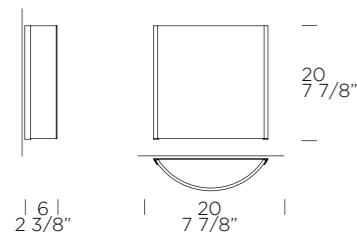
DESIGN**weight-volume** 1 kg - 0.020 m³**source** G9 1x3W Retrofit LED (not included) A+ / D**materials** blown and layered glass, brushed steel/*vetro soffiato e incamiciato, acciaio spazzolato***structure finish**

	brushed steel/ acciaio spazzolato
--	--------------------------------------

diffuser finish

	white/bianco
--	--------------

code

0001881

price VAT excluded

163,00 €

notesPolish finish diffuser/*Finitura diffusore lucida*Maximum supported power/*Potenza massima installabile*: G9 2xMAX 60W Halo (not included)Supplied with bulbs 2x48W G9/*Fornita con lampadina 1x48W G9***ALA PICCOLA P 16**

Mauro Marzollo, 2005

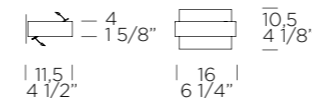
DESIGN**weight-volume** 1,3 kg - 0.010 m³**source** G9 1x3W Retrofit LED (not included) A+ / D**materials** metal**structure finish**

	white
	chrome

diffuser finish

	white
	chrome

code0001941
0001933**price VAT excluded**155,00 €
155,00 €**notes**

Maximum supported power: G9 1xMAX 60W Halo (not included)

ABBEY P

Riccardo Giovanetti, 2007

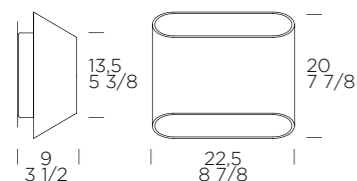
DESIGN**weight-volume** 1,5 kg - 0.003 m³**source** G9 2x3W Retrofit LED (not included) A+ / D**materials** blown and layered glass, metal/*vetro soffiato e incamiciato, metallo***structure finish**

	grey/grigio
	grey/grigio

diffuser finish

	white/bianco
	grey/grigio

code0002739
0002741**price VAT excluded**165,00 €
190,00 €**notes**Maximum supported power/*Potenza massima installabile*: G9 2xMAX 60W Halo (not included)**ALIAS P 15**

Works Studio, 2004

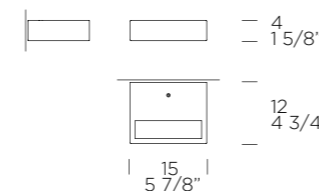
DESIGN**weight-volume** 2 kg - 0.010 m³**source** 2x8W LED 1300lm 3000K (included) A++ / A **LED****materials** metal, plastic/*metallo, materiale plastico***structure finish**

	white/bianco
	chrome/cromo lucido

diffuser finish

	gloss methacrylate/ bianco metacrilato
	gloss methacrylate/ bianco metacrilato

code0001876
0001872**price VAT excluded**195,00 €
210,00 €**notes**With electronic ballast/*Completa di alimentatore elettronico*
Dimmable upon request/*Dimmerabile su richiesta*

ALIAS P 35

Works Studio, 2004

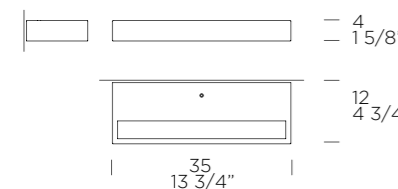
DESIGN**weight-volume** 2,8 kg - 0.030 m³**source** 4x8W LED 1300lm 3000K (included) A++ / A **LED****materials** metal, plastic/*metallo, materiale plastico*

finitura struttura	finitura diffusore	codice	prezzo imponibile	listino IVA 22% incl.
white/bianco	gloss methacrylate/ bianco metacrilato	0001923		285,00 €
chrome/cromo lucido	gloss methacrylate/ bianco metacrilato	0001904		320,00 €

notesWith electronic ballast/*Completa di alimentatore elettronico*
Dimmable upon request/*Dimmerabile su richiesta***ATELIER P**

Archirivolto, 2008

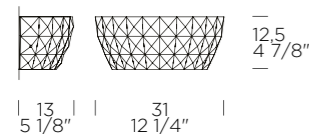
TRADITIONAL**weight-volume** 2,5 kg - 0.030 m³**source** R7s 114mm 1xMAX 120W Halo (not included) C / D**materials** handmade blown glass, metal/*vetro soffiato lavorato a mano, metallo*

structure finish	diffuser finish	code	price VAT excluded
chrome/cromo lucido	crystal/cristallo	0000479	368,00 €

BLOCK P 14

Leucos Design Lab, 2009

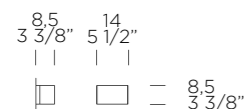
DESIGN**weight-volume** 1,54 kg - 0.010 m³**source** **G9** 1x3W Retrofit LED (not included) A+ / D**materials** silk-screened glass, steel/*vetro serigrafato, acciaio*

structure finish	diffuser finish	code	price VAT excluded
titanium-steel/ titanio e acciaio	gloss white/bianco lucido	0003812	169,00 €

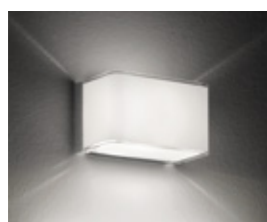
noteMaximum supported power/*Potenza massima installabile*: G9 1xMAX 48W Halo (not included)**weight-volume** 1,54 kg - 0.010 m³**source** 3x2W **LED** 600lm 2700K CRI>80 (included - replaceable LED) A++ **LED****materials** silk-screened glass, steel/*vetro serigrafato, acciaio*

structure finish	diffuser finish	code	price VAT excluded
titanium-steel/ titanio e acciaio	gloss white/bianco lucido	0003813	260,00 €

BLOCK P 29

Leucos Design Lab, 2009

DESIGN**weight-volume** 1,9 kg - 0.030 m³**source** **G9** 2x3W Retrofit LED (not included) A+ / D**materials** silk-screened glass, steel/*vetro serigrafato, acciaio*

structure finish	diffuser finish	code	price VAT excluded
titanium-steel/ titanio e acciaio	gloss white/bianco lucido	0003822	199,00 €

notesMaximum supported power/*Potenza massima installabile*: G9 2xMAX 48W Halo (not included)**weight-volume** 3,4 kg - 0.030 m³**source** 2x6W **LED** 1200lm 2700K CRI>80 (included - replaceable LED) A++ **LED****materials** silk-screened glass, steel/*vetro serigrafato, acciaio*

structure finish	diffuser finish	code	price VAT excluded
titanium-steel/ titanio e acciaio	gloss white/bianco lucido	0003824	299,00 €

BLOCK P 65

Leucos Design Lab, 2009

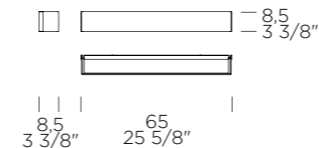
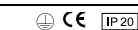
DESIGN**weight-volume** 4,9 kg - 0.080 m³**source** 3x13,3W LED 4000lm 2700K (included - replaceable LED) A++ **LED****materials** silk-screened glass, steel/*vetro serigrafato, acciaio*

structure finish	diffuser finish	code	price VAT excluded
white-steel/ titanio e acciaio	gloss white/bianco lucido	0003977	499,00 €

BLOCK P 100

Leucos Design Lab, 2009

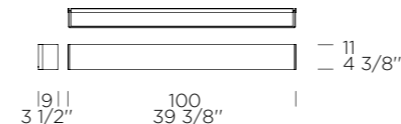
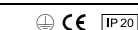
DESIGN**weight-volume** 7,8 kg - 0.190 m³**source** G5 2xMAX 39W Fluorescent (not included) A**materials** silk-screened glass, steel/*vetro serigrafato, acciaio*

structure finish	diffuser finish	code	price VAT excluded
white-steel/ titanio e acciaio	gloss white/bianco lucido	0004219	350,00 €

notesDimmable upon request/*Dimmerabile su richiesta*

BOLERO P 2

Carlo Nason, 2005

TRADITIONAL

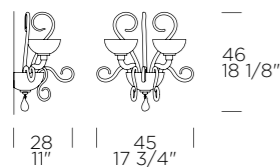

weight-volume 6,4 kg - 0.110 m³

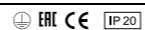

source G9 2x3W Retrofit LED (not included) A+ / D

materials handmade blown glass, metal/vetro soffiato lavorato a mano, metallo

structure finish	diffuser finish	code	price VAT excluded
chrome/cromo lucido	gloss white/bianco lucido	0000534	1.073,00 €
chrome/cromo lucido	transparent/trasparente	0000532	999,00 €

notes

Crystal pressed in ribs. Milky white smooth/
Lavorazione a coste per versione cristallo. Lavorazione liscia per versione biancolatte.
Maximum supported power/Potenza massima installabile: G9 2xMAX 60W Halo (not included)

CELINE P

Leucos Design Lab, 2002

DESIGN

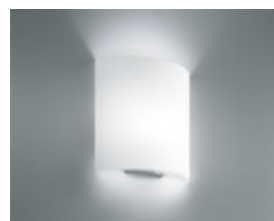
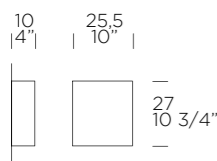

weight-volume 2,7 kg - 0.060 m³

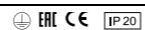

source E27 1x10W Retrofit LED (not included) A+ / E

materials blown glass, metal/vetro soffiato, metallo

structure finish	diffuser finish	code	price VAT excluded
brushed nickel/ nichel spazzolato	satin white/bianco lucido	0003805	180,00 €

notes

Maximum supported power/Potenza massima installabile: E27 1xMAX 100W Halo (not included)

CLASS P

Leucos Design Lab, 2001

DESIGN

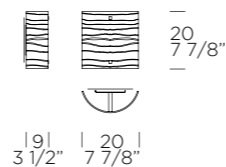

weight-volume 1 kg - 0.020 m³



source E27 1x15W Retrofit LED (not included) A+ / E

materials blown and layered glass with handmade grinding, metal/
vetro soffiato e incamiciato con molatura eseguita a mano, metallo

structure finish	diffuser finish	code	price VAT excluded
white-chrome/ bianco e cromo	satin milky white/ biancolatte satinato	0001878	180,00 €

notes

Maximum supported power/Potenza massima installabile: E27 1xMAX 100W Halo (not included)

GOLF P 1

Toso & Massari, 1992

DESIGN

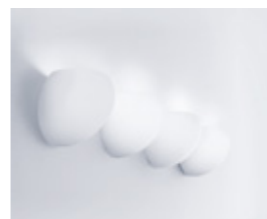

weight-volume 3,08 kg - 0.070 m³



source G9 1x3W Retrofit LED (not included) A+ / D

materials blown glass, metal/vetro soffiato, metallo

structure finish	diffuser finish	code	price VAT excluded
black/nero	satin white/bianco satinato	0003855	188,00 €

notes

Maximum supported power /Potenza massima installabile: G9 1xMAX 60W Halo (not included)

CELINE P 35

Leucos Design Lab, 2002

DESIGN

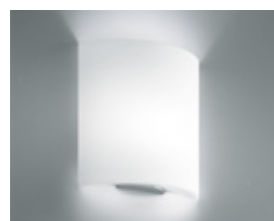
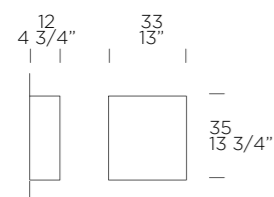

weight-volume 2 kg - 0.050 m³

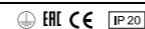

source E27 1x10W Retrofit LED (not included) A+ / E

materials blown glass, metal/vetro soffiato, metallo

structure finish	diffuser finish	code	price VAT excluded
brushed nickel/ nichel spazzolato	satin white/bianco lucido	0003955	262,00 €

notes

Maximum supported power/Potenza massima installabile: E27 1xMAX 150W Halo (not included)

GOLF P 1/SP

Toso & Massari, 1992

DESIGN



weight-volume 3,08 kg - 0.070 m³



source G9 1x3W Retrofit LED (not included) A+ / D

materials blown glass, metal/vetro soffiato, metallo

structure finish	diffuser finish	code	price VAT excluded
black/nero	chromed/cromatizzato	0003854	278,00 €

notes

Maximum supported power/Potenza massima installabile: G9 1xMAX 60W Halo (not included)

LILITH P

Leucos Design Lab, 2005

DESIGN

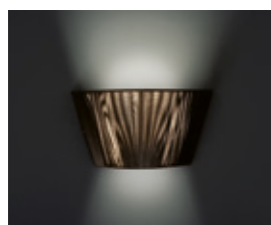
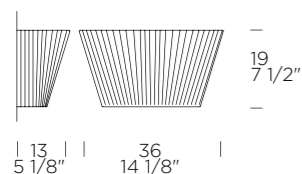

weight-volume 1,5 kg - 0.020 m³

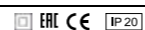

source E14 3x5W Retrofit LED (not included) A+ / E

materials cotton thread, nickel/*filo di cotone, nichel*

structure finish	diffuser finish	code	price VAT excluded
white/bianco	silver/argento	0000249	99,00 €
white/bianco	white/bianco	0000252	99,00 €
white/bianco	mocha/moka	0000261	99,00 €

notes Maximum supported power/*Potenza massima installabile*: E14 3xMAX 30W Halo (not included)

LINK P

Mauro Marzollo, 2005

DESIGN

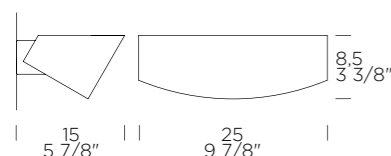

weight-volume 1,4 kg - 0.010 m³

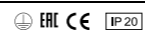

source R7s 114mm 1x10W Retrofit LED (not included) A+ / D

materials blown and layered glass, metal/*vetro soffiato e incamiciato, metallo*

structure finish	diffuser finish	code	price VAT excluded
brushed nickel/ <i>nichel spazzolato</i>	satin white/ <i>bianco satinato</i>	0002495	245,00 €
brushed nickel/ <i>nichel spazzolato</i>	black/ <i>nero</i>	0002499	245,00 €

notes Maximum supported power/*Potenza massima installabile*: R7s 114mm 1xMAX 120W Halo (not included)

OPI P

Alessandro Piva, 2011

DESIGN

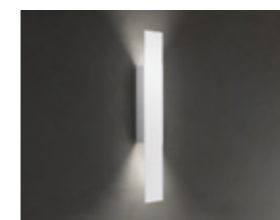
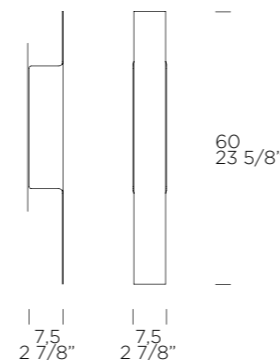

weight-volume 2,1 kg - 0.020 m³

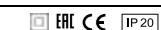

source GU10 2x7W Retrofit LED (not included) A+ / B

materials steel/*acciaio*

structure finish	diffuser finish	code	price VAT excluded
matte white/ <i>bianco opaco</i>	matte white/ <i>bianco opaco</i>	0001885	125,00 €
matte grey/ <i>grigio opaco</i>	matte grey/ <i>grigio opaco</i>	0001888	125,00 €

notes Maximum supported power/*Potenza massima installabile*: GU10 2xMAX 50W Halo (not included)

MODULO P 35

Toso, Massari & Associates, 1998

DESIGN

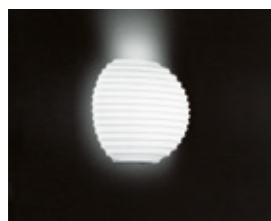
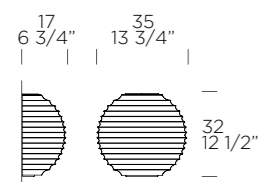

weight-volume 3,4 kg - 0.070 m³

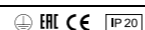

source E27 1x15W Retrofit LED (not included) A+ / E

materials blown glass, metal/*vetro soffiato, metallo*

structure finish	diffuser finish	code	price VAT excluded
brushed nickel/ <i>nichel spazzolato</i>	gloss white/ <i>bianco lucido</i>	0003902	311,00 €

notes Maximum supported power/*Potenza massima installabile*: E27 1xMAX 150W Halo (not included)

PASCALE P 40

Leucos Design Lab, 2015

TRADITIONAL

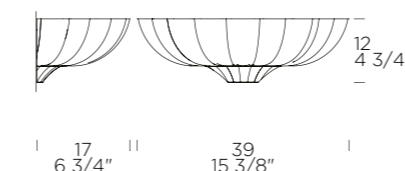

weight-volume 4,6 kg - 0.040 m³

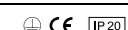

source G9 2x3W Retrofit LED (not included) A+ / E

materials curved cast glass pressed with "fracco", metal/
vetro a piastra colato e curvato a caldo con decoro a "fracco", metallo

structure finish	diffuser finish	code	price VAT excluded
chrome/ <i>romo lucido</i>	crystal/ <i>cristallo</i>	0000538	319,00 €

notes Maximum supported power/*Potenza massima installabile*: G9 2xMAX 33W Halo (not included)

PUCK P

Alessandro Crosera, 2010

DESIGN

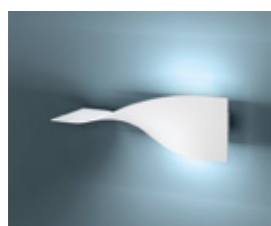
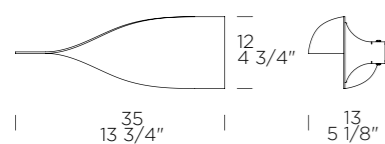

weight-volume 1,1 kg - 0.020 m³

ERL CE IP20

source 1x16W LED 1700lm **3000K** (included) A++ / A **LED**

materials metal/*metallo*

structure finish	diffuser finish	code	price VAT excluded
matte white/ <i>bianco opaco</i>	matte white/ <i>bianco opaco</i>	0002757	229,00 €

weight-volume 1,1 kg - 0.020 m³

ERL CE IP20

source 1x16W LED 1700lm **2700K** (included) A++ / A **LED**

materials metal/*metallo*

structure finish	diffuser finish	code	price VAT excluded
matte white/ <i>bianco opaco</i>	matte white/ <i>bianco opaco</i>	0004439	229,00 €

SERENISSIMA P

Leucos Design Lab, 1994

TRADITIONAL

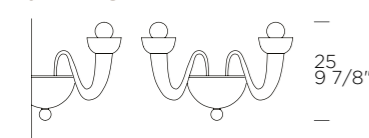

weight-volume 4 kg - 0.040 m³

ERL CE IP20

source E14 2x5W Retrofit LED (not included) A+ / E

materials handmade blown glass, metal/*vetro soffiato lavorato a mano, metallo*

structure finish	diffuser finish	code	price VAT excluded
gold/ <i>dorato lucido</i>	multicolor/ <i>multicolore</i>	0000615	1.122,00 €

notes Maximum supported power/*Potenza massima installabile*: E14 2xMAX 46W Halo (not included)

SPRING P

Eva Zeisel, 2012

DESIGN

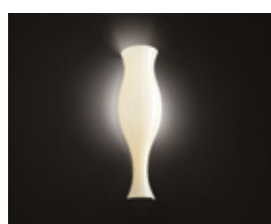
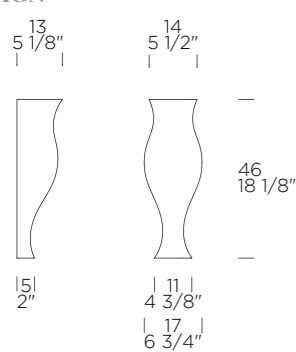

weight-volume 2,3 kg - 0.030 m³

CE IP20

source E27 1x10W Retrofit LED (not included) A+ / E

materials blown glass, metal/*vetro soffiato, metallo*

structure finish	diffuser finish	code	price VAT excluded
matte white/ <i>bianco opaco</i>	gloss white/ <i>bianco lucido</i>	0004292	352,00 €
matte white/ <i>bianco opaco</i>	gloss honey/ <i>giallo paglierino</i>	0004293	352,00 €

notes Maximum supported power/*Potenza massima installabile*: E27 1xMAX 77W Halo (not included)

SUMMER P

Eva Zeisel, 2012

DESIGN

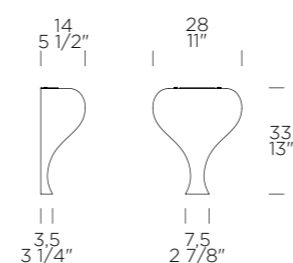

weight-volume 3 kg - 0.040 m³

CE IP20

source E27 1x10W Retrofit LED (not included) A+ / E

materials blown glass, metal/*vetro soffiato, metallo*

structure finish	diffuser finish	code	price VAT excluded
white/ <i>bianco opaco</i>	gloss white/ <i>bianco lucido</i>	0004286	237,00 €
white/ <i>bianco opaco</i>	gloss honey/ <i>giallo paglierino</i>	0004287	237,00 €

notes Maximum supported power/*Potenza massima installabile*: E27 1xMAX 77W Halo (not included)

VITTORIA P 2

Toso, Massari & Associates, 1992

DESIGN

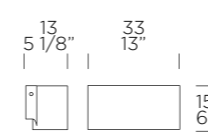

weight-volume 3,5 kg - 0.050 m³

ERL CE IP20

source **R7s** 80mm 1x10W Retrofit LED (not included) A+ / D

materials blown glass, metal/*vetro soffiato, metallo*

structure finish	diffuser finish	code	price VAT excluded
chrome/ <i>cromo lucido</i>	satın white/ <i>bianco satinato</i>	0003935	343,00 €

notes Maximum supported power: R7s 80mm 1xMAX 120W Halo (not included)

weight-volume 3,5 kg - 0.050 m³

ERL CE IP20

source 3x5W **LED** 1300lm 3000K (included) A++ / A **LED**

materials blown glass, metal/*vetro soffiato, metallo*

structure finish	diffuser finish	code	price VAT excluded
chrome/ <i>cromo lucido</i>	satın white/ <i>bianco satinato</i>	0003937	393,00 €

notes Phase cut dimming/*Dimmerabile a taglio di fase*

649 P

Leucos Design Lab, 1997

TRADITIONAL

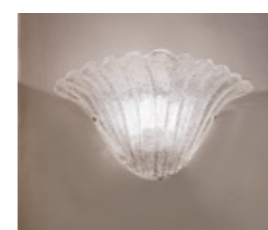
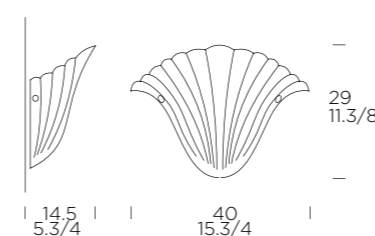

weight-volume 3,6 kg - 0.032 m³

CE IP20

source E27 1x10W Retrofit LED (not included) A+ / E

materials blown glass, metal/*vetro soffiato, metallo*

structure finish	diffuser finish	code	price VAT excluded
white/ <i>bianco</i>	transparent "graniglia"/ <i>trasparente graniglia</i>	000508	175,00 €

notes Maximum supported power/*Potenza massima installabile*: E27 1xMAX 77W Halo (not included)



BETAL
pag. 98
DESIGN



CUBI
pag. 99
DESIGN



FELIX
pag. 101
DESIGN



KEYRA
pag. 102
DESIGN



KUK
pag. 102
DESIGN



LOOP-LINE
pag. 103
DESIGN



MERCURE
pag. 103
DESIGN



MILD
pag. 103
DESIGN



NUBIA
pag. 104
DESIGN



PLANET
pag. 104
DESIGN



SELIS
pag. 105
DESIGN



STONE
pag. 106
DESIGN



TRECENTOESSANTAGRADI
pag. 106
DESIGN



WIMPY
pag. 107
DESIGN

BETA SMALL P-PL

Paolo Franzin, 2010

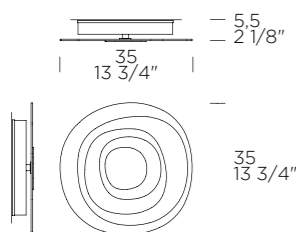
DESIGN**weight-volume** 3,7 kg - 0.070 m³**source** 2GX13 T5 1xMAX 22W Fluorescent (not included) A**materials** glass plates, steel/*vetro in lastra, acciaio***structure finish****diffuser finish****code****price VAT excluded**satin steel/*acciaio satinato*off: gloss white, on: shades of sand/*spento-bianco lucido, acceso-nuance sabbia*

0002707

262,00 €

notesWith electronic ballast/*Completa di alimentatore elettronico***BETA BIG P-PL**

Paolo Franzin, 2010

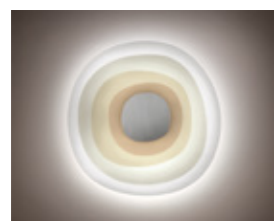
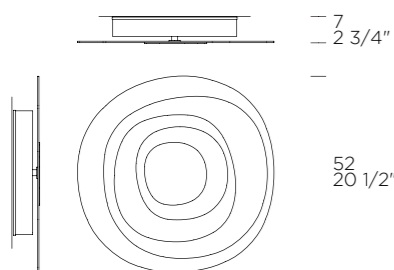
DESIGN**weight-volume** 11 kg - 0.150 m³**source** 2GX13 T5 1xMAX 22W Fluorescent (not included) A+

+ 2GX13 T5 1x40W Fluorescent (not included)

materials glass plates, steel/*vetro in lastra, acciaio***structure finish****diffuser finish****code****price VAT excluded**

satin steel

off: gloss white, on: shades of sand/*spento-bianco lucido, acceso-nuance sabbia*

0002709

327,00 €

notesWith electronic ballast/*Completa di alimentatore elettronico*
Dimmable upon request/*Dimmerabile su richiesta***CUBI P-PL 11**

Leucos Design Lab, 2000

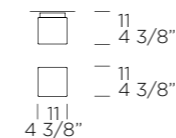
DESIGN**weight-volume** 1,1 kg - 0.008 m³**source** G9 1x3W Retrofit LED (not included) A+ / D**materials** blown and layered glass, polycarbonate/*vetro soffiato e incamiciato, policarbonato***structure finish****diffuser finish****code****price VAT excluded**grey/*grigio*satin white/*bianco satinato*

0001710

100,00 €

notesSatin finish/*Finitura satinata*Maximum supported power/*Potenza massima installabile*: G9 1xMAX 33W Halo (included)**weight-volume** 1 kg - 0.020 m³**source** 1x5W LED 500lm **3000K** (included - replaceable LED) A++ / A **LED****materials** blown and layered glass, anodized aluminium/*vetro soffiato e incamiciato, alluminio***structure finish****diffuser finish****code****price VAT excluded**grey/*grigio*satin white/*bianco satinato*

0001712

190,00 €

notesSatin finish/*Finitura satinata*With electronic ballast/*Completa di alimentatore elettronico***weight-volume** 1 kg - 0.020 m³**source** 1x4W LED 500lm **2700K** (included) - **IP44** A++ / A **LED****materials** blown and layered glass, anodized aluminium/*vetro soffiato e incamiciato, alluminio***structure finish****diffuser finish****code****price VAT excluded**grey/*grigio*satin white/*bianco satinato*

0001785

210,00 €

notesSatin finish/*Finitura satinata*With electronic ballast/*Completa di alimentatore elettronico***weight-volume** 1 kg - 0.043 m³**source** 1x4W LED 500lm **2700K** (included - replaceable LED) - **IP20** A++ / A **LED****materials** blown and layered glass, anodized aluminium/*vetro soffiato e incamiciato, alluminio***structure finish****diffuser finish****code****price VAT excluded**grey/*grigio*satin white/*bianco satinato*

0001787

160,00 €

notesSatin finish/*Finitura satinata*With electronic ballast/*Completa di alimentatore elettronico*

CUBI P-PL 16

Leucos Design Lab, 2000

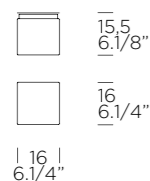

weight-volume 1 kg - 0.040 m³



source **G9** 1x3W Retrofit LED (not included) A+ / D

materials blown and layered glass, polycarbonate/*vetro soffiato e incamiciato, polycarbonato*

structure finish	diffuser finish	code	price VAT excluded
grey/grigio	satin white/ <i>bianco satinato</i>	0001670	130,00 €

notes

Satin finish/*Finitura satinata*

Maximum supported power/*Potenza massima installabile*: G9 1xMAX 48W Halo (included)

weight-volume 2,2 kg - 0.040 m³



source 3x5,8W LED 1320lm **3000K** (included - replaceable LED) A++ / A **LED**

materials blown and layered glass, anodized aluminium/*vetro soffiato e incamiciato, alluminio*

structure finish	diffuser finish	code	price VAT excluded
grey/grigio	satin white/ <i>bianco satinato</i>	0001671	230,00 €

notes

Satin finish/*Finitura satinata*

With electronic ballast/*Completa di alimentatore elettronico*

weight-volume 2,5 kg - 0.040 m³



source 2x6W LED 1440lm **2700K** (included) - **IP44** A++ / A **LED**

materials blown and layered glass, anodized aluminium/*vetro soffiato e incamiciato, alluminio*

structure finish	diffuser finish	code	price VAT excluded
grey/grigio	satin white/ <i>bianco satinato</i>	0001786	250,00 €

notes

Satin finish/*Finitura satinata*

With electronic ballast/*Completa di alimentatore elettronico*

Phase cut dimming/*Dimmerabile a taglio di fase*

weight-volume 2,2 kg - 0.040 m³



source 2x6W LED 1440lm **2700K** (included - replaceable LED) - **IP20** A++ / A **LED**

materials blown and layered glass, anodized aluminium/*vetro soffiato e incamiciato, alluminio*

structure finish	diffuser finish	code	price VAT excluded
grey/grigio	satin white/ <i>bianco satinato</i>	0001788	220,00 €

notes

Satin finish/*Finitura satinata*

With electronic ballast/*Completa di alimentatore elettronico*

Phase cut dimming/*Dimmerabile a taglio di fase*



CUBI P-PL 28

Leucos Design Lab, 2000

DESIGN

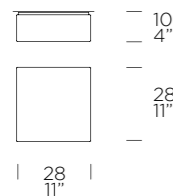

weight-volume 3 kg - 0.030 m³



source **E14** 4x5W Retrofit LED (not included) A+ / E

materials blown and layered glass, metal/*vetro soffiato e incamiciato, metallo*

structure finish	diffuser finish	code	price VAT excluded
grey/grigio	satin white/ <i>bianco satinato</i>	0001709	270,00 €

notes

Satin finish/*Finitura satinata*

Maximum supported power/*Potenza massima installabile*: E14 4xMAX 30W Halo (not included)

weight-volume 4 kg - 0.030 m³



source 1x15W **LED** 1800lm 3000K (included) A++ / A **LED**

materials blown and layered glass, metal/*vetro soffiato e incamiciato, metallo*

structure finish	diffuser finish	code	price VAT excluded
grey/grigio	satin white/ <i>bianco satinato</i>	0001804	320,00 €

notes

Satin finish/*Finitura satinata*

With electronic ballast/*Completa di alimentatore elettronico*

Dimmable upon request/*Dimmerabile su richiesta*



FELIX MINI P-PL

Leucos Design Lab, 1996

DESIGN

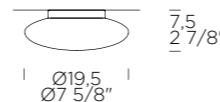

weight-volume 1 kg - 0.010 m³



source G9 1x3W Retrofit LED (not included) A+ / D

materials blown glass, metal/*vetro soffiato, metallo*

structure finish	diffuser finish	code	price VAT excluded
white/ <i>bianco</i>	satin white/ <i>bianco satinato</i>	0002383	87,00 €

notes

Maximum supported power/*Potenza massima installabile*: G9 1xMAX 48W Halo (not included)

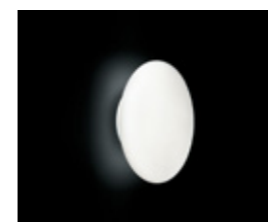

FELIX P-PL 35

Leucos Design Lab, 1996

DESIGN

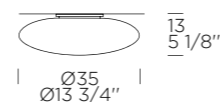

weight-volume 3,8 kg - 0.040 m³



source E27 2x10W Retrofit LED (not included) A+ / E

materials blown glass, metal/*vetro soffiato, metallo*

structure finish	diffuser finish	code	price VAT excluded
white/ <i>bianco</i>	satin white/ <i>bianco satinato</i>	0002382	280,00 €

notes

Maximum supported power/*Potenza massima installabile*: E27 2xMAX 46W Halo (not included)

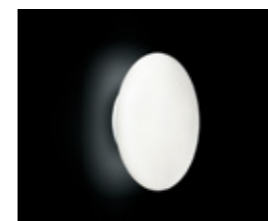

FELIX P-PL 47

Leucos Design Lab, 1996

DESIGN

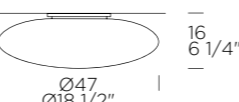

weight-volume 8,8 kg - 0.130 m³



source E27 3x10W Retrofit LED (not included) A+ / E

materials blown glass, metal/*vetro soffiato, metallo*

structure finish	diffuser finish	code	price VAT excluded
white/ <i>bianco</i>	satin white/ <i>bianco satinato</i>	0002386	384,00 €

notes

Maximum supported power/*Potenza massima installabile*: E27 3xMAX 57W Halo (not included)

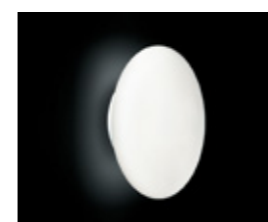

FELIX P-PL 55

Leucos Design Lab, 1996

DESIGN

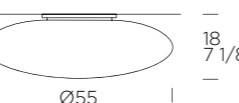

weight-volume 8,5 kg - 0.170 m³



source E27 3x10W Retrofit LED (not included) A+ / E

materials blown glass, metal/*vetro soffiato, metallo*

structure finish	diffuser finish	code	price VAT excluded
white/ <i>bianco</i>	satin white/ <i>bianco satinato</i>	0002389	499,00 €

notes

Maximum supported power/*Potenza massima installabile*: E27 3xMAX 57W Halo (not included)



KEYRA P-PL 30

Roberto Paoli, 2011

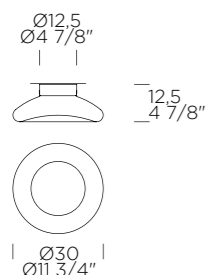
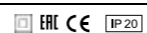
DESIGN**weight-volume** 2,5 kg - 0.040 m³**source** 1x13W LED 900lm 3000K (included) A++ / A **LED****materials** blown glass, metal/*vetro soffiato, metallo*

structure finish	diffuser finish	code	price VAT excluded
gloss white/ <i>bianco lucido</i>	transparent-satin white/ <i>trasparente parzialmente decorato</i>	0002431	507,00 €

notes
With electronic ballast/*Completa di alimentatore elettronico*

KEYRA P-PL 60

Roberto Paoli, 2011

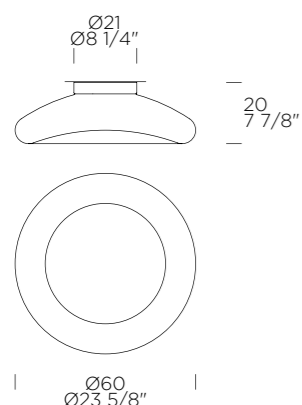
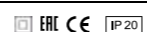
DESIGN**weight-volume** 11,6 kg - 0.160 m³**source** 2x13W LED 1800lm 3000K (included) A++ / A **LED****materials** blown glass, metal/*vetro soffiato, metallo*

structure finish	diffuser finish	code	price VAT excluded
gloss white/ <i>bianco lucido</i>	transparent-satin white/ <i>trasparente parzialmente decorato</i>	0002433	999,00 €

notes
With electronic ballast/*Completa di alimentatore elettronico*

KUK P-PL

Paolo Crepax, 2011

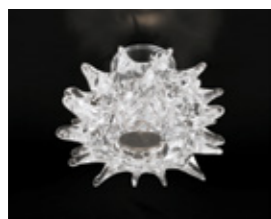
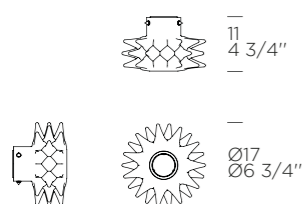
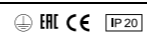
DESIGN**weight-volume** 2,3 kg - 0.020 m³**source** G9 1x3W Retrofit LED (not included) A+ / D**materials** handmade glass, metal/*vetro lavorato a mano, metallo*

structure finish	diffuser finish	code	price VAT excluded
chrome/ <i>cromo lucido</i>	transparent/ <i>trasparente</i>	0003780	376,00 €

notes
Maximum supported power/*Potenza massima installabile*: G9 1xMAX 48W Halo (not included)

LOOP-LINE P-PL 32

Toso, Massari & Associates With G. Toso, 2011

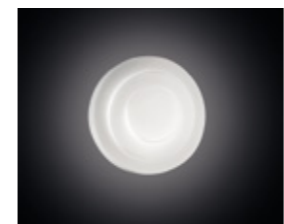
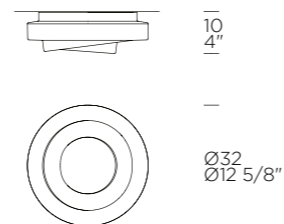
DESIGN**weight-volume** 4,9 kg - 0.060 m³**source** **E27** 2x10W Retrofit LED (not included) A+ / A**materials** blown glass, metal/*vetro soffiato, metallo*

structure finish	diffuser finish	code	price VAT excluded
white/ <i>bianco</i>	satin white/ <i>bianco satinato</i>	0003776	319,00 €

notes
Maximum supported power/*Potenza massima installabile*: E27 2xMAX 23W Fluorescent (not included)

weight-volume 5 kg - 0.060 m³**source** 1x15W **LED** 1800lm 3000K CRI>80 (included) A++ / A **LED****materials** blown glass, metal/*vetro soffiato, metallo*

structure finish	diffuser finish	code	price VAT excluded
white/ <i>bianco</i>	satin white/ <i>bianco satinato</i>	0003777	524,00 €

notes
Push Dimm 0-100% with external button. (The latter is not supplied)/
Dimmerabile Push 0-100% con pulsante esterno. (Pulsante esterno non fornito)
1-10V dimmable/*Dimmerabile 1-10V*
With electronic ballast/*Completa di alimentatore elettronico*

MERCURE P-PL

Patrick Jouin, 2008

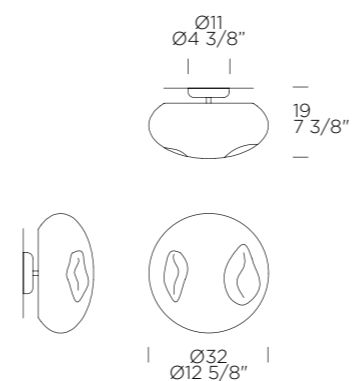
DESIGN**weight-volume** 3,9 kg - 0.060 m³**source** E14 3x5W Retrofit LED (not included) A+ / E**materials** blown glass, metal/*vetro soffiato, metallo*

structure finish	diffuser finish	code	price VAT excluded
chrome	pulegoso/mirrored	0002429	639,00 €

notes
Maximum supported power/*Potenza massima installabile*: E14 3xMAX 30W Halo (not included)

MILD P-PL

Jorge Pensi, 2005

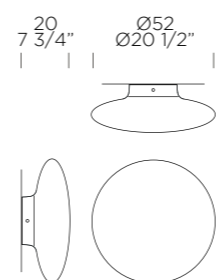
DESIGN**weight-volume** 8 kg - 0.170 m³**source** E27 1x15W Retrofit LED (not included) A+ / E**materials** blown glass, metal/*vetro soffiato, metallo*

structure finish	diffuser finish	code	price VAT excluded
white/ <i>bianco</i>	satin white/ <i>bianco satinato</i>	0004228	565,00 €

notes
Maximum supported power/*Potenza massima installabile*: E27 1xMAX 150W Halo (not included)

NUBIA P-PL 45

Toso, Massari & Associates, 1996

DESIGN

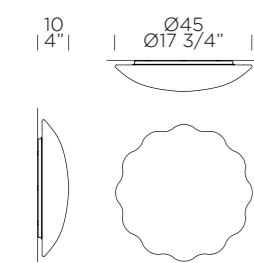

weight-volume 8,5 kg - 0.140 m³



source E14 3x5W Retrofit LED (not included) A+ / E

materials blown glass, metal/vetro soffiato, metallo

structure finish	diffuser finish	code	price VAT excluded
white/bianco	satin white/bianco satinato	0003732	589,00 €

notes Maximum supported power/Potenza massima installabile: E14 3xMAX 30W Halo (not included)

NUBIA P-PL 60

Toso, Massari & Associates, 1996

DESIGN

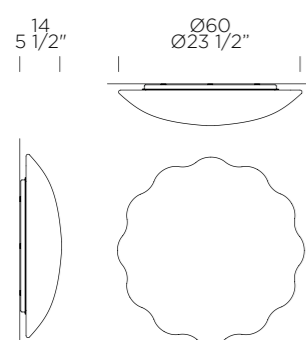

weight-volume 10,3 kg - 0.230 m³



source E27 3x15W Retrofit LED (not included) A+ / E

materials blown glass, metal/vetro soffiato, metallo

structure finish	diffuser finish	code	price VAT excluded
white/bianco	satin white/bianco satinato	0003739	917,00 €

notes Maximum supported power/Potenza massima installabile: E27 3xMAX 100W Halo (not included)

PLANET P-PL 48

Leucos Design Lab, 2008

DESIGN

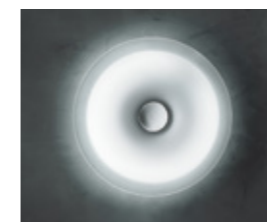
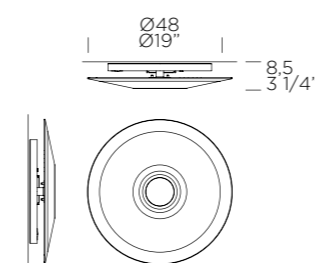

weight-volume 3,8 kg - 0.090 m³



source G9 6x3W Retrofit LED 1920lm (not included) A+ / D

materials slumped and screen-printed glass, metal/vetro termoformato e serigrafato, metallo

structure finish	diffuser finish	code	price VAT excluded
chrome/cromo lucido	satin white/bianco satinato	0003749	330,00 €

notes Maximum supported power/Potenza massima installabile: G9 6xMAX 33W Halo (not included)

weight-volume 3,8 kg - 0.090 m³



source 1x16W LED 2500lm 3000K CRI>80 (included - replaceable LED) A++ / A LED

materials slumped and screen-printed glass, metal/vetro termoformato e serigrafato, metallo

structure finish	diffuser finish	code	price VAT excluded
chrome/cromo lucido	satin white/bianco satinato	0003751	490,00 €

notes With electronic ballast/Completa di alimentatore elettronico
1-10V dimmable/Dimmerabile 1-10V
0-100% dimmable with external button (the latter is not supplied)/
Dimmerabile 0-100% con pulsante esterno (pulsante esterno non fornito)

PLANET P-PL 65

Leucos Design Lab, 2008

DESIGN

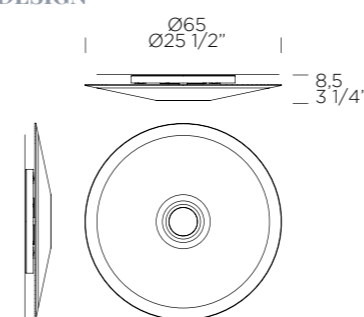

weight-volume 10,2 kg - 0.210 m³



source G9 6x3W Retrofit LED 1920lm (not included) A+ / D

materials slumped and screen-printed glass, metal/vetro termoformato e serigrafato, metallo

structure finish	diffuser finish	code	price VAT excluded
chrome/cromo lucido	satin white/bianco satinato	0003754	395,00 €

notes Maximum supported power/Potenza massima installabile: G9 6xMAX 33W Halo (not included)

weight-volume 10,5 kg - 0.210 m³



source 6x7,5W LED 6000lm 3000K CRI>80 (included) A++ / A LED

materials slumped and screen-printed glass, metal/vetro termoformato e serigrafato, metallo

structure finish	diffuser finish	code	price VAT excluded
chrome/cromo lucido	satin white/bianco satinato	0003756	620,00 €

notes With electronic ballast/Completa di alimentatore elettronico

PLANET P-PL 32

Leucos Design Lab, 2013

DESIGN

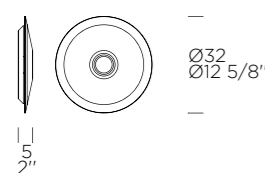

weight-volume 3,8 kg - 0.030 m³

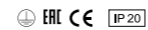

source 1x10W LED 1350lm 3000K CRI>80 (included) A++ / A LED

materials slumped and screen-printed glass, metal/vetro termoformato e serigrafato, metallo

structure finish	diffuser finish	code	price VAT excluded
chrome/cromo lucido	satin white/bianco satinato	0003727	240,00 €

notes With electronic ballast/Completa di alimentatore elettronico

SELIS P-PL 35 T

Toso & Massari, 1992

DESIGN

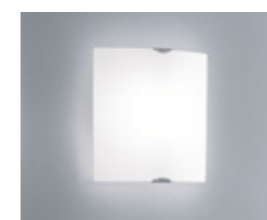
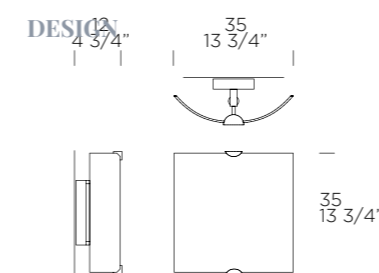

weight-volume 2,8 kg - 0.050 m³



source E27 1x15W Retrofit LED (not included) A+ / E

materials slumped glass, metal/vetro termoformato, metallo

structure finish	diffuser finish	code	price VAT excluded
chrome/cromo lucido	silk-screen printing satin white/bianco satinato serigrafato	0003762	237,00 €

notes Maximum supported power/Potenza massima installabile: E27 1xMAX 150W Halo (not included)

SELIS P-PL 45 T

Toso & Massari, 1992

DESIGN

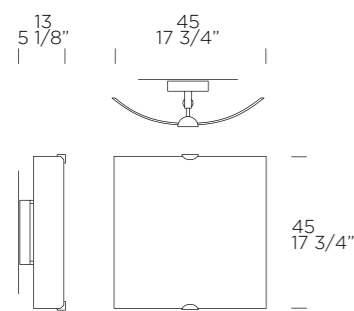

weight-volume 3,8 kg - 0.100 m³



source E27 1x15W Retrofit LED (not included) A+ / E

materials slumped glass, metal/slumped glass, metal/*vetro termoformato, metallo*

structure finish	diffuser finish	code	price VAT excluded
chrome/ <i>cromo lucido</i>	bianco satinato serigrafato/ <i>bianco satinato serigrafato</i>	0003765	270,00 €

notes
Maximum supported power/*Potenza massima installabile*: E27 1xMAX 150W Halo (not included)

STONE P-PL

Leucos Design Lab, 2006

DESIGN

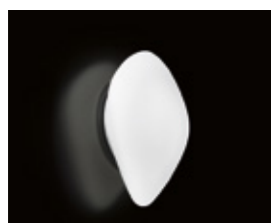
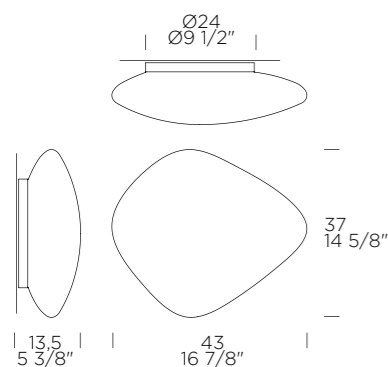

weight-volume 4,5 kg - 0.070 m³



source E27 2x10W Retrofit LED (not included) A+ / E

materials blown glass, metal/*vetro soffiato, metallo*

structure finish	diffuser finish	code	price VAT excluded
white/ <i>bianco</i>	satin white/ <i>bianco satinato</i>	0002684	245,00 €

notes
Maximum supported power/*Potenza massima installabile*: E27 2xMAX 46W Halo (not included)

TRECENTOESSANTAGRADI P-PL 200

Leucos Design Lab, 2000

DESIGN

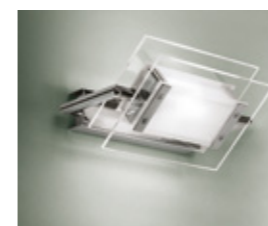
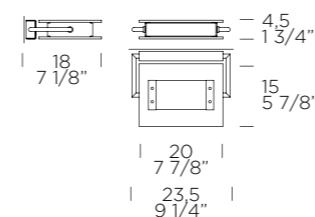

weight-volume 5,5 kg - 0.040 m³

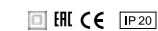

source 1x12W LED 1300lm 3000K (included) A++ / A **LED**

materials metal, heat-resistant glass/*metallo, vetro termoresistente*

structure finish	diffuser finish	code	price VAT excluded
chrome/ <i>cromo lucido</i>	satin/transparent/ <i>trasparente parzialmente satinato</i>	0001720	262,00 €
satin nickel/ <i>nichel satinato</i>	satin/transparent/ <i>trasparente parzialmente satinato</i>	0001729	262,00 €

accessories
single aluminium shield for 200 version/
schermo singolo paraluce in alluminio per versione 200

8000061	7,00 €
---------	--------

notes
With electronic ballast/*Completa di alimentatore elettronico*

WIMPY P-PL 16

Toso, Massari & Associates With G. Toso, 2013

DESIGN

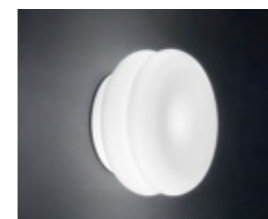
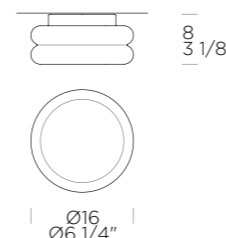

weight-volume 1,18 kg - 0.010 m³



source 1x6,4W LED 600lm **3000K** (included) A++ / A **LED**

materials blown glass, anodized aluminium/*vetro soffiato, alluminio anodizzato*

structure finish	diffuser finish	code	price VAT excluded
anodized aluminium/ <i>alluminio anodizzato</i>	satin white/ <i>bianco satinato</i>	0003791	207,00 €

weight-volume 1,18 kg - 0.010 m³



source 1x4W LED 500lm **2700K** (included) - **IP44** A++ / A **LED**

materials blown glass, anodized aluminium/*vetro soffiato, alluminio anodizzato*

structure finish	diffuser finish	code	price VAT excluded
anodized aluminium/ <i>alluminio anodizzato</i>	satin white/ <i>bianco satinato</i>	0003797	245,00 €

notes
Phase-cut dimmer/*Dimmerabile a taglio di fase*

WIMPY P-PL 32

Toso, Massari & Associates With G. Toso, 2013

DESIGN

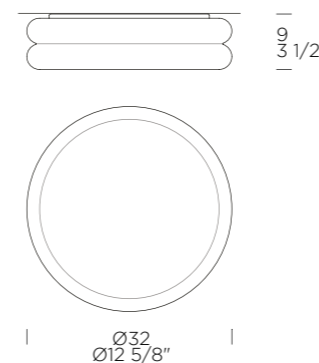

weight-volume 3 kg - 0.030 m³



source 1x15W LED 1800lm 3000K (included) A++ / A **LED**

materials blown glass, anodized aluminium/*vetro soffiato, alluminio anodizzato*

structure finish	diffuser finish	code	price VAT excluded
anodized aluminium/ <i>alluminio anodizzato</i>	satin white/ <i>bianco satinato</i>	0003794	360,00 €

TRECENTOESSANTAGRADI P-PL 120

Leucos Design Lab, 2000

DESIGN

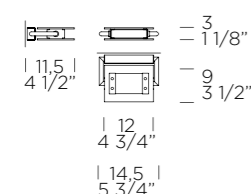

weight-volume 0,8 kg - 0.010 m³



source G9 1x3W Retrofit LED (not included) A+ / D

materials metal, heat-resistant glass/*metallo, vetro termoresistente*

structure finish	diffuser finish	code	price VAT excluded
chrome/ <i>cromo lucido</i>	satin-transparent/ <i>trasparente parzialmente satinato</i>	0001718	134,00 €
satin nickel/ <i>nichel satinato</i>	satin/transparent/ <i>trasparente parzialmente satinato</i>	0001727	134,00 €

accessories
single aluminium shield for 120 version/
schermo singolo paraluce in alluminio per versione 120

8000060	7,00 €
---------	--------

notes
Maximum supported power/*Potenza massima installabile*: G9 1xMAX 60W Halo (not included)



ATELIER
pag. 112

TRADITIONAL



BOLERO
pag. 112

TRADITIONAL



DELUXE
pag. 112

DESIGN



ELYSEE
pag. 113

TRADITIONAL



LILITH
pag. 113

DESIGN



LOOP-LINE

pag. 114

DESIGN



MODULO

pag. 115

DESIGN



ORLEANS

pag. 115

TRADITIONAL



PASCALE

pag. 115

TRADITIONAL



REED

pag. 116

DESIGN



SPHERA

pag. 117

DESIGN



649

pag. 118

TRADITIONAL

ATELIER PL 32

Archirivolto, 2008

TRADITIONAL

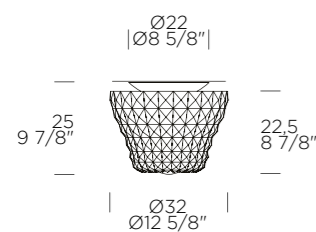

weight-volume	7 kg - 0.080 m ³	
source	E27 3x10W Retrofit LED (not included) A+ / E	
materials	handmade blown glass, metal/ <i>vetro soffiato lavorato a mano, metallo</i>	
structure finish	diffuser finish	code
chrome/ <i> Cromo lucido</i>	crystal/ <i> cristallo</i>	0000328
notes	Maximum supported power/ <i>Potenza massima installabile</i> : E27 3xMAX 46W Halo (not included)	
		price VAT excluded
		655,00 €

BOLERO PL 75

Carlo Nason, 2006

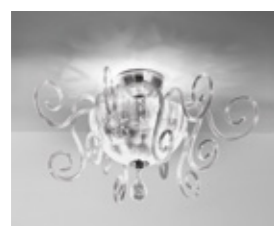
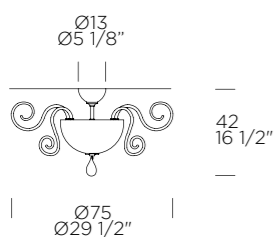

weight-volume	7,6 kg - 0.110 m ³	
source	E14 4x5W Retrofit LED (not included) A+ / E	
materials	handmade blown glass, metal/ <i>vetro soffiato lavorato a mano, metallo</i>	
structure finish	diffuser finish	code
chrome/ <i> Cromo lucido</i>	gloss white/ <i> bianco lucido</i>	0000381
chrome/ <i> Cromo lucido</i>	transparent/ <i> trasparente</i>	0000379
notes	Crystal pressed in ribs. Milky white smooth <i>Lavorazione a coste per versione cristallo. Lavorazione liscia per versione biancolatte</i> Maximum supported power/ <i>Potenza massima installabile</i> : E14 4xMAX 46W Halo (not included)	
		price VAT excluded
		1.007,00 €
		934,00 €

DELUXE PL 35

Archirivolto, 2006

DESIGN

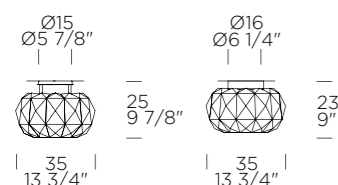

weight-volume	6,5 kg - 0.090 m ³	
source	R7s 80mm 1x10W Retrofit LED (not included) A+ / D	
materials	blown glass, metal/ <i>vetro soffiato, metallo</i>	
structure finish	diffuser finish	code
chrome/ <i> Cromo lucido</i>	satin white/ <i> bianco satinato</i>	0002263
chrome/ <i> Cromo lucido</i>	matte black/ <i> nero opaco</i>	0002267
notes	Maximum supported power/ <i>Potenza massima installabile</i> : R7s 80mm 1xMAX 120W Halo (not included)	
weight-volume	6,5 kg - 0.090 m ³	
source	1x19W LED 2400lm 3000K CRI 80 (included) A++ / A LED	
materials	blown glass, metal/ <i>vetro soffiato, metallo</i>	
structure finish	diffuser finish	code
chrome/ <i> Cromo lucido</i>	satin white/ <i> bianco satinato</i>	0008127
chrome/ <i> Cromo lucido</i>	matte black/ <i> nero opaco</i>	0008128
notes	1-10V dimmable/ <i>Dimmerabile 1-10V</i> 0-100% dimmable with external button (the latter is not supplied)/ <i>Dimmerabile 0-100% con pulsante esterno (pulsante esterno non fornito)</i> With electronic ballast/ <i>Completa di alimentatore elettronico</i>	
		price VAT excluded
		581,00 €
		606,00 €
		794,00 €
		827,00 €

DELUXE PL 50

Archirivolto, 2006

DESIGN

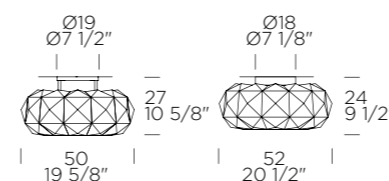

weight-volume	9,7 kg - 0.150 m ³	
source	R7s 114mm 1x10W Retrofit LED (not included) A+ / D	
materials	blown glass, metal/ <i>vetro soffiato, metallo</i>	
structure finish	diffuser finish	code
chrome/ <i> Cromo lucido</i>	satin white/ <i> bianco satinato</i>	0002264
chrome/ <i> Cromo lucido</i>	matte black/ <i> nero opaco</i>	0002268
notes	Maximum supported power/ <i>Potenza massima installabile</i> : R7s 114mm 1xMAX 160W Halo (not included)	
weight-volume	9,7 kg - 0.150 m ³	
source	1x29W LED 3300lm 3000K CRI 80 (included) A++ / A LED	
materials	blown glass, metal/ <i>vetro soffiato, metallo</i>	
structure finish	diffuser finish	code
chrome/ <i> Cromo lucido</i>	satin white/ <i> bianco satinato</i>	0008131
chrome/ <i> Cromo lucido</i>	matte black/ <i> nero opaco</i>	0008132
notes	1-10V dimmable/ <i>Dimmerabile 1-10V</i> 0-100% dimmable with external button (the latter is not supplied)/ <i>Dimmerabile 0-100% con pulsante esterno (pulsante esterno non fornito)</i> DALI dimmable/ <i>Dimmerabile DALI</i> With electronic ballast/ <i>Completa di alimentatore elettronico</i>	
		price VAT excluded
		860,00 €
		901,00 €
		1.073,00 €
		1.114,00 €

ELYSEE PL 60

Marina Toscano, 2009

TRADITIONAL

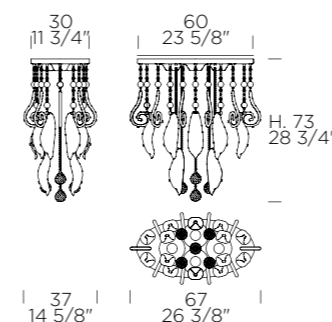

weight-volume	16,2 kg - 0.270 m ³	
source	GU10 4x7W Retrofit LED (not included) A+ / D	
materials	handmade blown glass, metal/ <i>vetro soffiato lavorato a mano, metallo</i>	
structure finish	diffuser finish	code
white/ <i> bianco</i>	transparent/ <i> trasparente</i>	0000404
white/ <i> bianco</i>	transparent-silver leaf/ <i> trasparente foglia argento</i>	0000402
notes	Maximum supported power/ <i>Potenza massima installabile</i> : GU10 4xMAX 50W Halo (not included)	
		price VAT excluded
		3.107,00 €
		3.189,00 €

LILITH PL 40

Leucos Design Lab, 2005

DESIGN

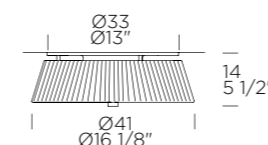

weight-volume	4,8 kg - 0.070 m ³	
source	E14 3x5W Retrofit LED (not included) A+ / E	
materials	cotton thread, nickel/ <i>filo di cotone, nichel</i>	
structure finish	diffuser finish	code
white/brushed nickel/ <i> bianco e nickel spazzolato</i>	silver/ <i> argento</i>	0000006
white/brushed nickel/ <i> bianco e nickel spazzolato</i>	white/ <i> bianco</i>	0000012
white/brushed nickel/ <i> bianco e nickel spazzolato</i>	mocha/ <i> moka</i>	0000029
notes	Maximum supported power/ <i>Potenza massima installabile</i> : E14 3xMAX 30W Halo (not included)	
		price VAT excluded
		216,00 €
		216,00 €
		216,00 €

LILITH PL 55

Leucos Design Lab, 2005

DESIGN

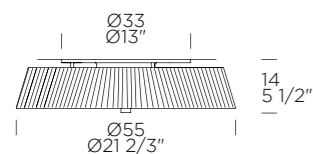

weight-volume 7,3 kg - 0.130 m³

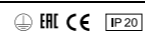

source E27 4x10W Retrofit LED (not included) A+ / E

materials cotton thread, nickel/*filo di cotone, nichel*

structure finish	diffuser finish	code	price VAT excluded
white/brushed nickel/ <i>bianco e nickel spazzolato</i>	silver/argento	0000007	270,00 €
white/brushed nickel/ <i>bianco e nickel spazzolato</i>	white/bianco	0000013	270,00 €
white/brushed nickel/ <i>bianco e nickel spazzolato</i>	mocha/moka	0000030	270,00 €

notes
Maximum supported power/*Potenza massima installabile*: E27 4xMAX 30W Halo (not included)

LILITH PL 70

Leucos Design Lab, 2005

DESIGN

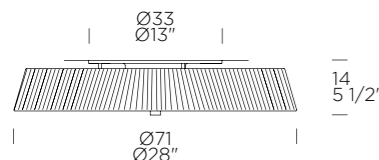

weight-volume 9,8 kg - 0.160 m³

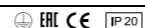

source E27 6x10W Retrofit LED (not included) A+ / E

materials cotton thread, nickel/*filo di cotone, nichel*

structure finish	diffuser finish	code	price VAT excluded
white/brushed nickel/ <i>bianco e nickel spazzolato</i>	silver/argento	0000039	352,00 €
white/brushed nickel/ <i>bianco e nickel spazzolato</i>	white/bianco	0000043	352,00 €
white/brushed nickel/ <i>bianco e nickel spazzolato</i>	mocha/moka	0000054	352,00 €

notes
Maximum supported power/*Potenza massima installabile*: E27 6xMAX 30W Halo (not included)

MODULO PL 35

Toso, Massari & Associates, 1998

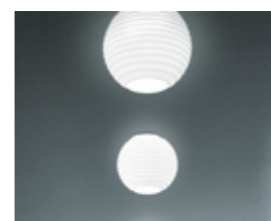
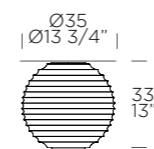

weight-volume 6,3 kg - 0.160 m³



source E27 1x15W Retrofit LED (not included) A+ / E

materials blown glass, metal/*vetro soffiato, metallo*

structure finish	diffuser finish	code	price VAT excluded
black/nero	gloss white/ <i>bianco lucido</i>	0003039	368,00 €

notes
Maximum supported power/*Potenza massima installabile*: E27 1xMAX 150W Halo (not included)

LOOP-LINE PL 60

Toso, Massari & Associates With G. Toso, 2011

DESIGN

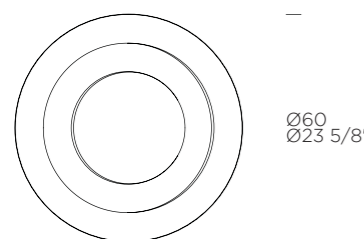
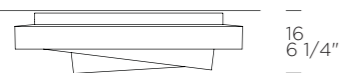

weight-volume 16,7 kg - 0.180 m³



source 3x15W LED 5400lm 3000K CRI>80 (included) A++ / A LED

materials blown glass, metal/*vetro soffiato, metallo*

structure finish	diffuser finish	code	price VAT excluded
white/bianco	satin white/ <i>bianco satinato</i>	0003056	1.253,00 €

notes
Push Dimm with external button. (The latter is not supplied)/
Dimmerabile Push con pulsante esterno. (Pulsante esterno non fornito)
1-10V dimmable/*Dimmerabile 1-10V*

PASCALE PL 30

Leucos Design Lab, 2005

TRADITIONAL

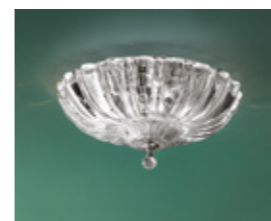
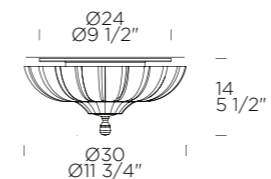

weight-volume 4 kg - 0.080 m³

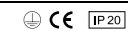

source G9 3x3W Retrofit LED (not included) A+ / E

materials curved cast glass pressed with "fracco", metal/
vetro a piastra colato e curvato a caldo con decoro a "fracco", metallo

structure finish	diffuser finish	code	price VAT excluded
chrome/ <i> Cromo lucido</i>	crystal/ <i> cristallo</i>	0000410	409,00 €

notes
Maximum supported power/*Potenza massima installabile*: G9 3xMAX 33W Halo (not included)

PASCALE PL 40

Leucos Design Lab, 2005

TRADITIONAL

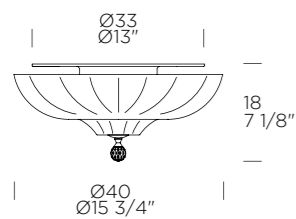

weight-volume 7,75 kg - 0.080 m³

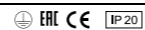

source E14 3x5W Retrofit LED (not included) A+ / E

materials curved cast glass pressed with "fracco", metal/
vetro a piastra colato e curvato a caldo con decoro a "fracco", metallo

structure finish	diffuser finish	code	price VAT excluded
chrome/cromo lucido	crystal/cristallo	0000385	516,00 €

notes
Maximum supported power/Potenza massima installabile: E14 3xMAX 46W Halo (not included)

REED PL 180

Patrick Jouin, 2009

DESIGN

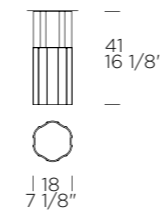

weight-volume 4,2 kg - 0.030 m³



source E27 1x15W Retrofit LED (not included) A+ / E

materials handmade blown glass, aluminium/vetro soffiato lavorato a mano, alluminio

structure finish	diffuser finish	code	price VAT excluded
lacquered aluminium nickel/ alluminio laccato nichel	transparent/trasparente	0002275	368,00 €

notes
Special version upon request. For more details view "SPECIAL VERSIONS" chapter
A richiesta versioni speciali. Per maggiori dettagli vedi capitolo "VERSIONI SPECIALI"
Maximum supported power/Potenza massima installabile: GU10 1xMAX 75W Halo (not included)

REED PL 90

Patrick Jouin, 2009

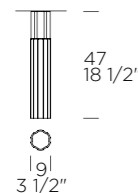

weight-volume 2,2 kg - 0.020 m³



source GU10 1x7W Retrofit LED (not included) A+ / B

materials handmade blown glass, aluminium/vetro soffiato lavorato a mano, alluminio

structure finish	diffuser finish	code	price VAT excluded
lacquered aluminium nickel/ alluminio laccato nichel	transparent/trasparente	0002271	270,00 €

notes
Special version upon request. For more details view "SPECIAL VERSIONS" chapter
A richiesta versioni speciali. Per maggiori dettagli vedi capitolo "VERSIONI SPECIALI"
Maximum supported power/Potenza massima installabile: GU10 1xMAX 50W Halo (not included)

SPHERA PL 29

Matteo Thun, 2000

DESIGN

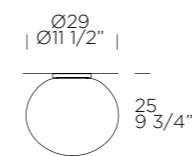

weight-volume 4,3 kg - 0.080 m³



source E27 1x15W Retrofit LED (not included) A+ / E

materials blown glass, metal/vetro soffiato, metallo

structure finish	diffuser finish	code	price VAT excluded
white/bianco	satin white/bianco satinato	0003043	189,00 €

notes
Maximum supported power/Potenza massima installabile: E27 1xMAX 100W Halo (not included)

REED PL 135

Patrick Jouin, 2009

DESIGN

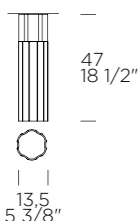

weight-volume 3,49 kg - 0.030 m³



source GU10 1x7W Retrofit LED (not included) A+ / B

materials handmade blown glass, aluminium

structure finish	diffuser finish	code	price VAT excluded
lacquered aluminium nickel/ alluminio laccato nichel	transparent/trasparente	0002273	335,00 €

notes
Special version upon request. For more details view "SPECIAL VERSIONS" chapter
A richiesta versioni speciali. Per maggiori dettagli vedi capitolo "VERSIONI SPECIALI"
Maximum supported power/Potenza massima installabile: GU10 1xMAX 75W Halo (not included)

SPHERA PL 37

Matteo Thun, 2000

DESIGN

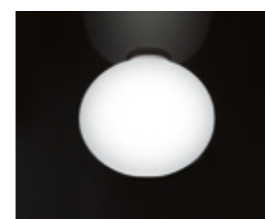
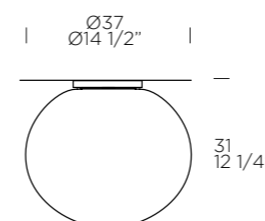

weight-volume 6,1 kg - 0.150 m³



source E27 1x15W Retrofit LED (not included) A+ / E

materials blown glass, metal/vetro soffiato, metallo

structure finish	diffuser finish	code	price VAT excluded
white/bianco	satin white/bianco satinato	0003046	239,00 €

notes
Maximum supported power/Potenza massima installabile: E27 1xMAX 150W Halo (not included)

649 PL 45

Leucos Design Lab, 1997

TRADITIONAL

Ø 45
Ø 17.3/4"



weight-volume 7,00 kg - 0,077 m³

source E14 3x5W Retrofit LED (not included) A+ / E

materials blown glass, metal/*vetro soffiato, metallo*

structure finish	diffuser finish	code	price VAT excluded
white/ <i>bianco</i>	transparent "graniglia"/ <i>trasparente graniglia</i>	0000345	336,00 €

note
Maximum supported power/*Potenza massima installabile*: E14 3xMAX 46W Halo (not included)

649 PL 65

Leucos Design Lab, 1997

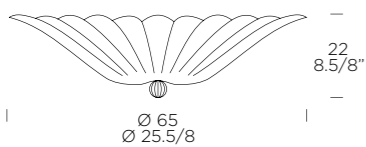
TRADITIONAL

Ø 65
Ø 25.5/8"



weight-volume 16,70 kg - 0,161 m³

source E27 3x15W Retrofit LED (not included) A+ / E

materials blown glass, metal/*vetro soffiato, metallo*

structure finish	diffuser finish	code	price VAT excluded
white/ <i>bianco</i>	transparent graniglia/ <i>trasparente graniglia</i>	0000343	497,00 €

note
Maximum supported power/*Potenza massima installabile*: E27 3xMAX 60W Halo (not included)

RECESSED**INCASSO**

GLASS DOWNLIGHTS / FARETTI IN VETRO



BAIA
pag. 122
RECESSED



DAY
pag. 123
RECESSED



DIAMANTE
pag. 123
RECESSED



DISK
pag. 124
RECESSED



DROP
pag. 124
RECESSED



HELIOS
pag. 125
RECESSED



IGEA
pag. 125
RECESSED



ISIDE
pag. 126
RECESSED



MIRA
pag. 126
RECESSED



ONY
pag. 127
RECESSED



PEGASO
pag. 127
RECESSED



POLAR
pag. 128
RECESSED



QUASAR
pag. 128
RECESSED



SIDERAL
pag. 129
RECESSED



SITH
pag. 129
RECESSED



SPIRA
pag. 130
RECESSED



STAR
pag. 131
RECESSED



STEP
pag. 131
RECESSED



SUN
pag. 132
RECESSED



VAN
pag. 132
RECESSED

ALUMINUM DOWNLIGHTS / FARETTI IN ALLUMINIO



SD 802
pag. 133
RECESSED



SD 803
pag. 133
RECESSED



SD 902
pag. 133
RECESSED



SD 903
pag. 134
RECESSED

PLASTER DOWNLIGHTS / FARETTI IN GESSO

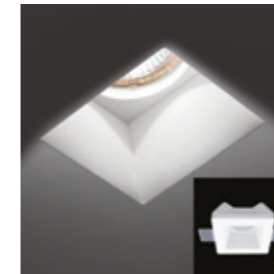

SD 081 N
pag. 134
RECESSED

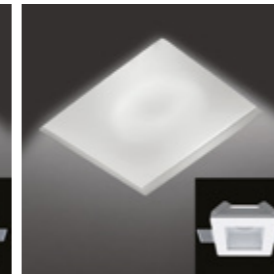

SD 081V N
pag. 134
RECESSED

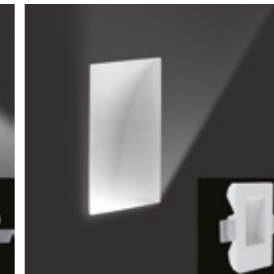

SD 084 N
pag. 135
RECESSED

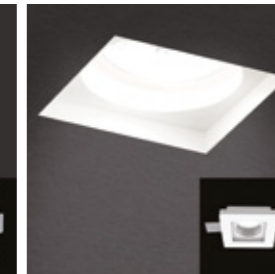

SD 085
pag. 135
RECESSED

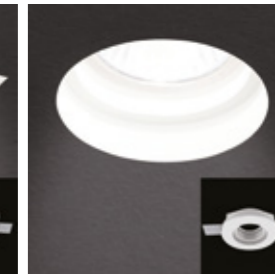

SD 086
pag. 135
RECESSED



SD 087
pag. 136
RECESSED



SD 087V
pag. 136
RECESSED

BAIA I

Mauro Marzollo, 1991

RECESSED

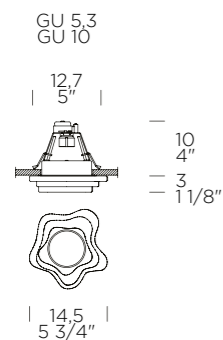

GU 10 LED MASTER

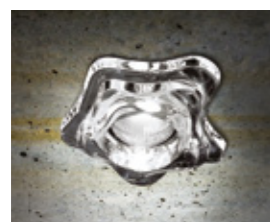
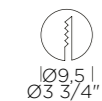
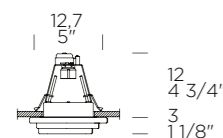

weight-volume 1 kg - 0.010 m³

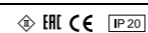

source **GU5,3** 1x8W Retrofit LED (not included) A+ / B

materials glass, metal/*vetro, metallo*

structure finish	diffuser finish	code	price VAT excluded
chrome/ <i> Cromo lucido</i>	transparent crystal/ <i> cristallo</i>	0000833	106,00 €
chrome/ <i> Cromo lucido</i>	satin crystal/ <i> bianco satinato</i>	0000837	122,00 €

accessories electronic transformer 50W 12V/*trasformatore elettronico 50W 12V* 8000142 48,00 €

notes Transformer not included/*Trasformatore non compreso*
Maximum supported power/*Potenza massima installabile*: GU5,3 1xMAX 50W Halo (not included)

weight-volume 1 kg - 0.010 m³



source **GU10** 1xMAX 50W Halo (not included) D

materials glass, metal/*vetro, metallo*

structure finish	diffuser finish	code	price VAT excluded
chrome/ <i> Cromo lucido</i>	transparent crystal/ <i> cristallo</i>	0000834	122,00 €
chrome/ <i> Cromo lucido</i>	satin crystal/ <i> bianco satinato</i>	0000838	130,00 €

weight-volume 1,04 kg - 0.010 m³



source **GU10** 1x7W Retrofit **LED MASTER** (not included) A++ / A

materials glass, metal/*vetro, metallo*

structure finish	diffuser finish	code	price VAT excluded
chrome/ <i> Cromo lucido</i>	transparent crystal/ <i> cristallo</i>	0000836	139,00 €
chrome/ <i> Cromo lucido</i>	satin crystal/ <i> bianco satinato</i>	0000840	147,00 €

notes LED power max 7W with maximum length of bulb GU10=h 80.5mm/
Potenza LED installabile max 7W con altezza massima lampadina GU10=h 80.5mm

DAY I

Toso, Massari & Associates, 1998

RECESSED

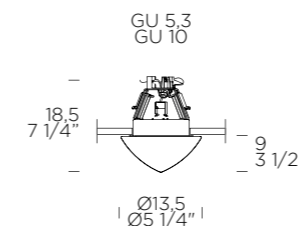

GU 10 LED MASTER

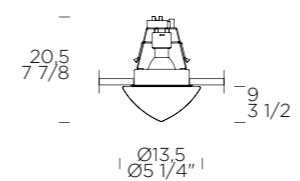

Foro Ø9,5 - Opening Ø3 3/4

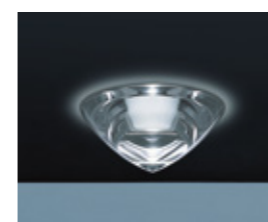

weight-volume 1,4 kg - 0.020 m³

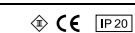

source **GU5,3** 1x8W Retrofit LED (not included) A++ / B

materials glass, metal/*vetro, metallo*

structure finish	diffuser finish	code	price VAT excluded
chrome/ <i> Cromo lucido</i>	crystal/ <i> cristallo</i>	0004237	130,00 €
chrome/ <i> Cromo lucido</i>	satin crystal/ <i> bianco satinato</i>	0004236	139,00 €

accessories electronic transformer 50W 12V/*trasformatore elettronico 50W 12V* 8000142 48,00 €

notes Transformer not included/*Trasformatore non compreso*
Maximum supported power/*Potenza massima installabile*: GU5,3 1xMAX 50W Halo (not included)

weight-volume 1,45 kg - 0.020 m³



source **GU10** 1xMAX 50W Halo (not included) D

materials glass, metal/*vetro, metallo*

structure finish	diffuser finish	code	price VAT excluded
chrome/ <i> Cromo lucido</i>	crystal/ <i> cristallo</i>	0004239	130,00 €
chrome/ <i> Cromo lucido</i>	satin crystal/ <i> bianco satinato</i>	0004238	139,00 €

weight-volume 1,45 kg - 0.020 m³



source **GU10** 1x7W Retrofit **LED MASTER** (not included) A++ / A

materials glass, metal/*vetro, metallo*

structure finish	diffuser finish	code	price VAT excluded
chrome/ <i> Cromo lucido</i>	satin crystal/ <i> bianco satinato</i>	0004242	147,00 €
chrome/ <i> Cromo lucido</i>	crystal/ <i> cristallo</i>	0004243	147,00 €

notes LED power max 7W with maximum length of bulb GU10=h 80.5mm/
Potenza LED installabile max 7W con altezza massima lampadina GU10=h 80.5mm

DIAMANTE I

Leucos Design Lab, 2002

RECESSED

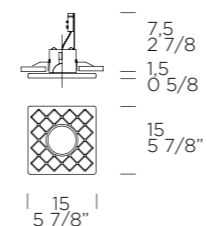

weight-volume 1 kg - 0.010 m³

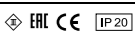

source GU5,3 1x8W Retrofit LED (not included) A+ / B

materials curved cast glass pressed with "fracco", metal/
vetro a piastra colato e curvato a caldo con decoro a "fracco", metallo

structure finish	diffuser finish	code	price VAT excluded
white/ <i> bianco</i>	transparent/ <i> trasparente</i>	0000317	106,00 €

accessories electronic transformer 50W 12V/*trasformatore elettronico 50W 12V* 8000142 48,00 €

notes Transformer not included/*Trasformatore non compreso*
Maximum supported power/*Potenza massima installabile*: GU5,3 1xMAX 50W Halo (not included)

DISK I

Toso, Massari & Associates, 2001

RECESSED

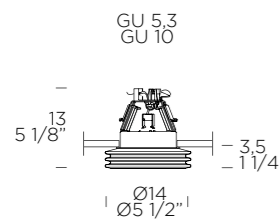

GU 10 LED MASTER

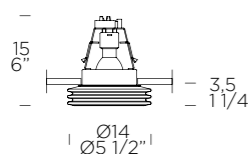

Foro Ø9,5 - Opening Ø3 3/4

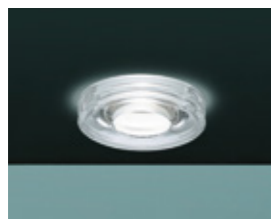

weight-volume 1,3 kg - 0.020 m³

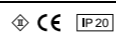

source **GU5,3** 1x8W Retrofit LED (not included) A++ / B

materials glass, metal/*vetro, metallo*

structure finish	diffuser finish	code	price VAT excluded
chrome/ <i>chromo lucido</i>	crystal/ <i>crystallo</i>	0004245	147,00 €
chrome/ <i>chromo lucido</i>	satin white/ <i>bianco satinato</i>	0004244	163,00 €

accessories

electronic transformer 50W 12V/*trasformatore elettronico 50W 12V* 8000142 48,00 €

notes

Transformer not included/*Trasformatore non compreso*
Maximum supported power/*Potenza massima installabile*: GU5,3 1xMAX 50W Halo (not included)

weight-volume 1,35 kg - 0.020 m³

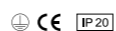

source **GU10** 1xMAX 50W Halo (not included) D

materials glass, metal/*vetro, metallo*

structure finish	diffuser finish	code	price VAT excluded
chrome/ <i>chromo lucido</i>	crystal/ <i>crystallo</i>	0004247	147,00 €
chrome/ <i>chromo lucido</i>	satin white/ <i>bianco satinato</i>	0004246	163,00 €

weight-volume 1,8 kg - 0.020 m³



source **GU10** 1x7W Retrofit **LED MASTER** (not included) A++ / A

materials glass, metal/*vetro, metallo*

structure finish	diffuser finish	code	price VAT excluded
chrome/ <i>chromo lucido</i>	crystal/ <i>crystallo</i>	0004251	171,00 €
chrome/ <i>chromo lucido</i>	satin white/ <i>bianco satinato</i>	0004250	180,00 €

notes

LED power max 7W with maximum length of bulb GU10=h 80.5mm/
Potenza LED installabile max 7W con altezza massima lampadina GU10=h 80.5mm

DROP I

Toso, Massari & Associates, 1998

RECESSED

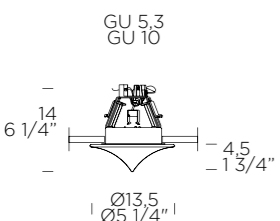

GU 10 LED MASTER

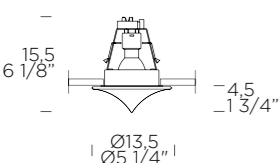

Foro Ø9,5 - Opening Ø3 3/4



weight-volume 0,76 kg - 0.020 m³



source **GU5,3** 1x8W Retrofit LED (not included) A++ / B

materials glass, metal/*vetro, metallo*

structure finish	diffuser finish	code	price VAT excluded
chrome/ <i>chromo lucido</i>	satin white/ <i>bianco satinato</i>	0004252	122,00 €
chrome/ <i>chromo lucido</i>	crystal/ <i>crystallo</i>	0004253	122,00 €

accessories

electronic transformer 50W 12V/*trasformatore elettronico 50W 12V* 8000142 48,00 €

notes

Transformer not included/*Trasformatore non compreso*
Maximum supported power/*Potenza massima installabile*: GU5,3 1xMAX 50W Halo (not included)

weight-volume 0,8 kg - 0.020 m³



source **GU10** 1xMAX 50W Halo (not included) D

materials glass, metal/*vetro, metallo*

structure finish	diffuser finish	code	price VAT excluded
chrome/ <i>chromo lucido</i>	crystal/ <i>crystallo</i>	0004255	122,00 €
chrome/ <i>chromo lucido</i>	satin white/ <i>bianco satinato</i>	0004254	130,00 €

weight-volume 0,8 kg - 0.020 m³



source **GU10** 1x7W Retrofit **LED MASTER** (not included) A++ / A

materials glass, metal/*vetro, metallo*

structure finish	diffuser finish	code	price VAT excluded
chrome/ <i>chromo lucido</i>	crystal/ <i>crystallo</i>	0004259	139,00 €
chrome/ <i>chromo lucido</i>	satin white/ <i>bianco satinato</i>	0004258	147,00 €

notes

LED power max 7W with maximum length of bulb GU10=h 80.5mm/
Potenza LED installabile max 7W con altezza massima lampadina GU10=h 80.5mm

HELIOS I

Mauro Marzollo, 2001

RECESSED

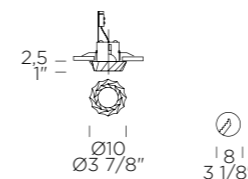

weight-volume 1 kg - 0.010 m³

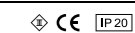

source **GU5,3** 1x8W Retrofit LED (not included) A++ / B

materials glass, metal/*vetro, metallo*

structure finish	diffuser finish	code	price VAT excluded
white/ <i>bianco</i>	crystal/ <i>crystallo</i>	0002256	68,00 €

accessories

electronic transformer 50W 12V/*trasformatore elettronico 50W 12V* 8000142 48,00 €

notes

Transformer not included/*Trasformatore non compreso*
Maximum supported power/*Potenza massima installabile*: GU5,3 1xMAX 50W Halo (not included)

IGEA 2 I

Roberto Pamio, 1991

RECESSED

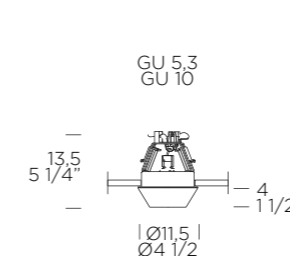

GU 10 LED MASTER

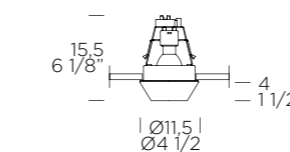

foro Ø 9,5 - Opening Ø 3 3/4

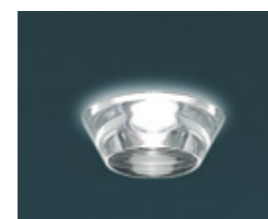

weight-volume 0,77 kg - 0.020 m³

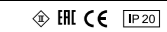

source **GU5,3** 1x8W Retrofit LED (not included) A++ / B

materials glass, metal/*vetro, metallo*

structure finish	diffuser finish	code	price VAT excluded
chrome/ <i>chromo lucido</i>	crystal/ <i>crystallo</i>	0002963	98,00 €
chrome/ <i>chromo lucido</i>	satin white/ <i>bianco satinato</i>	0002965	106,00 €

accessories

electronic transformer 50W 12V/*trasformatore elettronico 50W 12V* 8000142 48,00 €

notes

Transformer not included/*Trasformatore non compreso*
Maximum supported power/*Potenza massima installabile*: GU5,3 1xMAX 50W Halo (not included)

weight-volume 0,8 kg - 0.020 m³

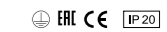

source **GU10** 1xMAX 50W Halo (not included) D

materials glass, metal/*vetro, metallo*

structure finish	diffuser finish	code	price VAT excluded
chrome/ <i>chromo lucido</i>	crystal/ <i>crystallo</i>	0002964	122,00 €
chrome/ <i>chromo lucido</i>	satin white/ <i>bianco satinato</i>	0002966	122,00 €

weight-volume 0,8 kg - 0.020 m³



source **GU10** 1x7W Retrofit **LED MASTER** (not included) A++ / A

materials glass, metal/*vetro, metallo*

structure finish	diffuser finish	code	price VAT excluded
chrome/ <i>chromo lucido</i>	crystal/ <i>crystallo</i>	0002886	130,00 €
chrome/ <i>chromo lucido</i>	satin white/ <i>bianco satinato</i>	0002888	130,00 €

notes

LED power max 7W with maximum length of bulb GU10=h 80.5mm/
Potenza LED installabile max 7W con altezza massima lampadina GU10=h 80.5mm

ISIDE 2 I

Roberto Pamio, 1991

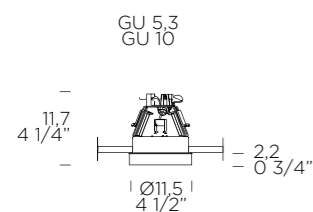
RECESSED

GU 10 LED MASTER

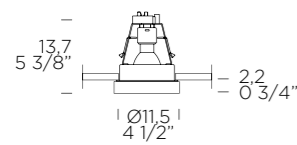

Foro Ø 9,5 - Opening Ø3 3/4



weight-volume	0,76 kg - 0.020 m ³		CE IP20
source	GU5,3 1x8W Retrofit LED (not included) A++ / B		
materials	glass, metal/ <i>vetro, metallo</i>		
structure finish	diffuser finish	code	price VAT excluded
chrome/ <i>chromo lucido</i>	satin white/ <i>bianco satinato</i>	0004260	122,00 €
chrome/ <i>chromo lucido</i>	crystal/ <i>cristallo</i>	0004261	122,00 €
accessories	electronic transformer 50W 12V/ <i>trasformatore elettronico 50W 12V</i>		8000142 48,00 €
notes	Transformer not included/ <i>Trasformatore non compreso</i> Maximum supported power/ <i>Potenza massima installabile</i> : GU5,3 1xMAX 50W Halo (not included)		

weight-volume	0,8 kg - 0.020 m ³		CE IP20
source	GU10 1xMAX 50W Halo (not included) D		
materials	glass, metal/ <i>vetro, metallo</i>		
structure finish	diffuser finish	code	price VAT excluded
chrome/ <i>chromo lucido</i>	crystal/ <i>cristallo</i>	0004263	122,00 €
chrome/ <i>chromo lucido</i>	satin white/ <i>bianco satinato</i>	0004262	130,00 €

weight-volume	0,8 kg - 0.020 m ³		CE IP20
source	GU10 1x7W Retrofit LED MASTER (not included) A++ / A		
materials	glass, metal/ <i>vetro, metallo</i>		
structure finish	diffuser finish	code	price VAT excluded
chrome/ <i>chromo lucido</i>	satin white/ <i>bianco satinato</i>	0004266	139,00 €
chrome/ <i>chromo lucido</i>	crystal/ <i>cristallo</i>	0004267	139,00 €
notes	LED power max 7W with maximum length of bulb GU10=h 80.5mm/ <i>Potenza LED installabile max 7W con altezza massima lampadina GU10=h 80.5mm</i>		

MIRA 2 I

Roberto Pamio, 1991

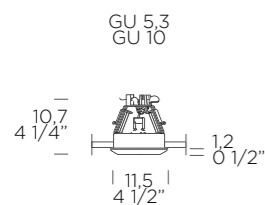
RECESSED

GU 10 LED MASTER

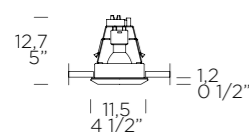

Foro Ø9,5 - Opening Ø3 3/4

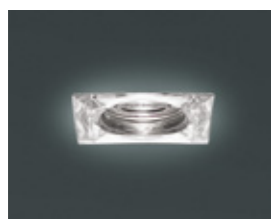

weight-volume	0,58 kg - 0.020 m ³		ERL CE IP20
source	GU5,3 1x8W Retrofit LED (not included) A++ / B		
materials	glass, metal/ <i>vetro, metallo</i>		
structure finish	diffuser finish	code	price VAT excluded
chrome/ <i>chromo lucido</i>	crystal/ <i>cristallo</i>	0002844	106,00 €
chrome/ <i>chromo lucido</i>	satin crystal/ <i>bianco satinato</i>	0002846	114,00 €
accessories	electronic transformer 50W 12V/ <i>trasformatore elettronico 50W 12V</i>		8000142 48,00 €
notes	Transformer not included/ <i>Trasformatore non compreso</i> Maximum supported power/ <i>Potenza massima installabile</i> : GU5,3 1xMAX 50W Halo (not included)		

weight-volume	0,82 kg - 0.020 m ³		ERL CE IP20
source	GU10 1xMAX 50W Halo (not included) D		
materials	glass, metal/ <i>vetro, metallo</i>		
structure finish	diffuser finish	code	price VAT excluded
chrome/ <i>chromo lucido</i>	crystal/ <i>cristallo</i>	0002845	114,00 €
chrome/ <i>chromo lucido</i>	satin crystal/ <i>bianco satinato</i>	0002847	122,00 €

weight-volume	0,58 kg - 0.020 m ³		ERL CE IP20
source	GU10 1x7W Retrofit LED MASTER (not included) A++ / A		
materials	glass, metal/ <i>vetro, metallo</i>		
structure finish	diffuser finish	code	price VAT excluded
chrome/ <i>chromo lucido</i>	transparent crystal	0002890	130,00 €
chrome/ <i>chromo lucido</i>	satin crystal/ <i>bianco satinato</i>	0002892	139,00 €
notes	LED power max 7W with maximum length of bulb GU10=h 80.5mm/ <i>Potenza LED installabile max 7W con altezza massima lampadina GU10=h 80.5mm</i>		

ONLY I

Toso, Massari & Associates, 2001

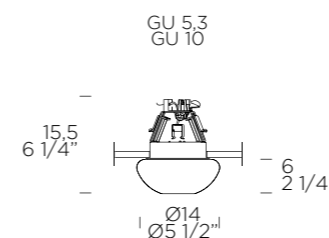
RECESSED

GU 10 LED MASTER

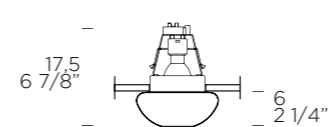

Foro Ø9,5 - Opening Ø3 3/4

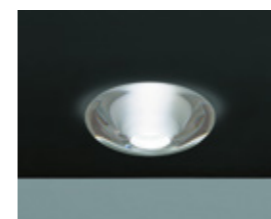

weight-volume	1,8 kg - 0.020 m ³		CE IP20
source	GU5,3 1x8W Retrofit LED (not included) A++ / B		
materials	glass, metal/ <i>vetro, metallo</i>		
structure finish	diffuser finish	code	price VAT excluded
chrome/ <i>chromo lucido</i>	satin white/ <i>bianco satinato</i>	0004268	166,00 €
chrome/ <i>chromo lucido</i>	crystal/ <i>cristallo</i>	0004269	175,00 €
accessories	electronic transformer 50W 12V/ <i>trasformatore elettronico 50W 12V</i>		8000142 48,00 €
notes	Transformer not included/ <i>Trasformatore non compreso</i> Maximum supported power/ <i>Potenza massima installabile</i> : GU5,3 1xMAX 50W Halo (not included)		

weight-volume	1,85 kg - 0.020 m ³		CE IP20
source	GU10 1xMAX 50W Halo (not included) D		
materials	glass, metal/ <i>vetro, metallo</i>		
structure finish	diffuser finish	code	price VAT excluded
chrome/ <i>chromo lucido</i>	satin white/ <i>bianco satinato</i>	0004270	166,00 €
chrome/ <i>chromo lucido</i>	crystal/ <i>cristallo</i>	0004271	180,00 €

weight-volume	1,8 kg - 0.020 m ³		CE IP20
source	GU10 1x7W Retrofit LED MASTER (not included) A++ / A		
materials	glass, metal/ <i>vetro, metallo</i>		
structure finish	diffuser finish	code	price VAT excluded
chrome/ <i>chromo lucido</i>	satin white/ <i>bianco satinato</i>	0004274	180,00 €
chrome/ <i>chromo lucido</i>	crystal/ <i>cristallo</i>	0004275	183,00 €
notes	LED power max 7W with maximum length of bulb GU10=h 80.5mm/ <i>Potenza LED installabile max 7W con altezza massima lampadina GU10=h 80.5mm</i>		

PEGASO I

Orietta Indovino, 2000

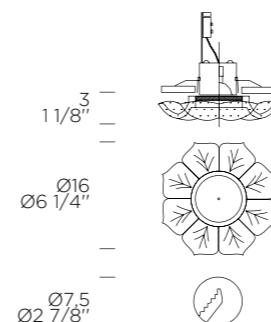
RECESSED

weight-volume	0,8 kg - 0.010 m ³		ERL CE IP20
source	GU5,3 1x8W Retrofit LED (not included) A+ / C		
materials	curved cast glass pressed with "fracco", metal <i>vetro a piastra colato e curvato a caldo con decoro a "fracco", metallo</i>		
structure finish	diffuser finish	code	price VAT excluded
white/ <i>bianco</i>	transparent graniglia/ <i>trasparente graniglia</i>	0000313	98,00 €
white/ <i>bianco</i>	amber-amber graniglia/ <i>ambra con graniglia ambra</i>	0000315	98,00 €
accessories	electronic transformer 50W 12V/ <i>trasformatore elettronico 50W 12V</i>		8000142 48,00 €
notes	Transformer not included/ <i>Trasformatore non compreso</i> Maximum supported power/ <i>Potenza massima installabile</i> : GU5,3 1xMAX 50W Halo (not included)		

POLAR I

Toso, Massari & Associates, 2001

RECESSED

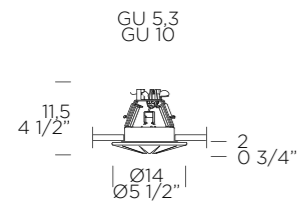

GU 10 LED MASTER

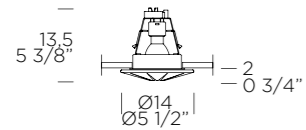

Foro Ø9,5 - Opening Ø3 3/4

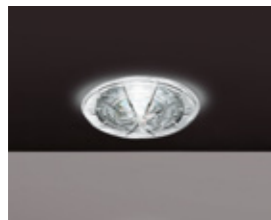

weight-volume	0,87 kg - 0.020 m ³			⊕ ENEC CE IP20
source	GU5,3 1x8W Retrofit LED (not included) A++ / B			
materials	glass, metal/ <i>vetro, metallo</i>			
structure finish	diffuser finish	code	price VAT excluded	
■ galvanized metal/ <i>metallo zincato</i>	□ crystal/ <i>cristallo</i>	0002849	122,00 €	
■ galvanized metal/ <i>metallo zincato</i>	■ satin crystal/ <i>bianco satinato</i>	0002852	130,00 €	
accessories	electronic transformer 50W 12V/ <i>trasformatore elettronico 50W 12V</i>	8000142	48,00 €	
notes	Transformer not included/ <i>Trasformatore non compreso</i> Maximum supported power/ <i>Potenza massima installabile</i> : GU5,3 1xMAX 50W Halo (not included)			

weight-volume	0,92 kg - 0.020 m ³			⊕ ENEC CE IP20
source	GU10 1xMAX 50W Halo (not included) D			
materials	glass, metal/ <i>vetro, metallo</i>			
structure finish	diffuser finish	code	price VAT excluded	
■ galvanized metal/ <i>metallo zincato</i>	□ crystal/ <i>cristallo</i>	0002850	122,00 €	
■ galvanized metal/ <i>metallo zincato</i>	■ satin crystal/ <i>bianco satinato</i>	0002853	139,00 €	

weight-volume	0,92 kg - 0.020 m ³			⊕ ENEC CE IP20
source	GU10 1x7W Retrofit LED MASTER (not included) A++ / A			
materials	glass, metal/ <i>vetro, metallo</i>			
structure finish	diffuser finish	code	price VAT excluded	
■ galvanized metal/ <i>metallo zincato</i>	□ crystal/ <i>cristallo</i>	0002894	139,00 €	
■ galvanized metal/ <i>metallo zincato</i>	■ satin crystal/ <i>bianco satinato</i>	0002897	139,00 €	
notes	LED power max 7W with maximum length of bulb GU10=h 80.5mm/ <i>Potenza LED installabile max 7W con altezza massima lampadina GU10=h 80.5mm</i>			

QUASAR I

Mauro Marzollo, 2001

RECESSED

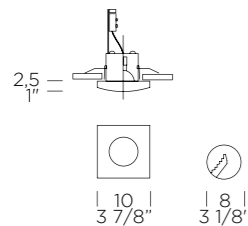

weight-volume	1 kg - 0.010 m ³			⊕ ENEC CE IP20
source	GU5,3 1x8W Retrofit LED (not included) A++ / B			
materials	glass, metal/ <i>vetro, metallo</i>			
structure finish	diffuser finish	code	price VAT excluded	
■ white/ <i>bianco</i>	■ satin crystal/ <i>bianco satinato</i>	0002250	75,00 €	
accessories	electronic transformer 50W 12V/ <i>trasformatore elettronico 50W 12V</i>	8000142	48,00 €	
notes	Transformer not included/ <i>Trasformatore non compreso</i> Maximum supported power/ <i>Potenza massima installabile</i> : GU5,3 1xMAX 50W Halo (not included)			

SIDERAL I

Mauro Marzollo, 2001

RECESSED

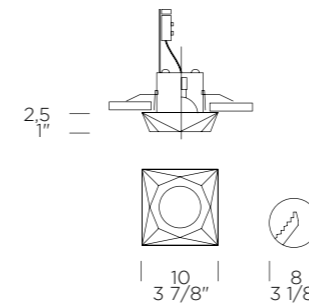

weight-volume	1 kg - 0.010 m ³			⊕ CE IP20
source	GU5,3 1x8W Retrofit LED (not included) A++ / B			
materials	glass, metal/ <i>vetro, metallo</i>			
structure finish	diffuser finish	code	price VAT excluded	
■ white/ <i>bianco</i>	□ crystal/ <i>cristallo</i>	0002252	81,00 €	
accessories	electronic transformer 50W 12V/ <i>trasformatore elettronico 50W 12V</i>	8000142	48,00 €	
notes	Transformer not included/ <i>Trasformatore non compreso</i> Maximum supported power/ <i>Potenza massima installabile</i> : GU5,3 1xMAX 50W Halo (not included)			

SITH I

Roberto Pamio, 1991

RECESSED

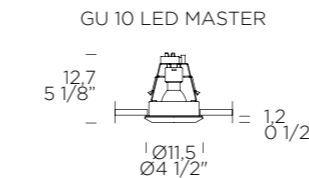
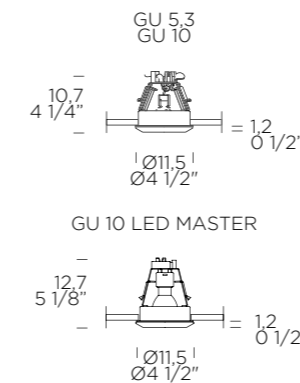

Foro Ø9,5 - Opening Ø3 3/4



weight-volume	0,56 kg - 0.020 m ³			⊕ ENEC CE IP20
source	GU5,3 1x8W Retrofit LED (not included) A+ / B			
materials	glass, metal/ <i>vetro, metallo</i>			
structure finish	diffuser finish	code	price VAT excluded	
■ chrome/ <i> Cromo lucido</i>	■ satin crystal/ <i>bianco satinato</i>	0002961	98,00 €	
■ chrome/ <i> Cromo lucido</i>	□ crystal/ <i>cristallo</i>	0002959	122,00 €	
accessories	electronic transformer 50W 12V/ <i>trasformatore elettronico 50W 12V</i>	8000142	48,00 €	
notes	Transformer not included/ <i>Trasformatore non compreso</i> Maximum supported power/ <i>Potenza massima installabile</i> : GU5,3 1xMAX 50W Halo (not included)			

weight-volume	0,61 kg - 0.020 m ³			⊕ ENEC CE IP20
source	GU10 1xMAX 50W Halo (not included) D			
materials	glass, metal/ <i>vetro, metallo</i>			
structure finish	diffuser finish	code	price VAT excluded	
■ chrome/ <i> Cromo lucido</i>	■ satin crystal/ <i>bianco satinato</i>	0002962	106,00 €	
■ chrome/ <i> Cromo lucido</i>	□ crystal/ <i>cristallo</i>	0002960	122,00 €	

weight-volume	0,61 kg - 0.020 m ³			⊕ ENEC CE IP20
source	GU10 1x7W Retrofit LED MASTER 600lm (not included) A++ / A			
materials	glass, metal/ <i>vetro, metallo</i>			
structure finish	diffuser finish	code	price VAT excluded	
■ chrome/ <i> Cromo lucido</i>	□ crystal/ <i>cristallo</i>	0002882	130,00 €	
■ chrome/ <i> Cromo lucido</i>	■ satin crystal/ <i>bianco satinato</i>	0002884	130,00 €	
notes	Transformer not included/ <i>Trasformatore non compreso</i> Maximum supported power/ <i>Potenza massima installabile</i> : GU5,3 1xMAX 50W Halo (not included)			

SPIRA I

Mauro Marzollo, 2001

RECESSED

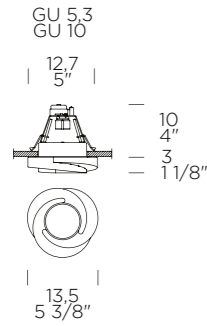

weight-volume 1,08 kg - 0.010 m³

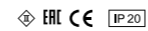

source **GU5,3** 1x8W Retrofit LED (not included) A+ / B

materials glass, metal/*vetro, metallo*

structure finish	diffuser finish	code	price VAT excluded
chrome/ <i>chromo lucido</i>	crystal/ <i>cristallo</i>	0000989	106,00 €
chrome/ <i>chromo lucido</i>	satin crystal/ <i>bianco satinato</i>	0000993	122,00 €

accessories

electronic transformer 50W 12V/*trasformatore elettronico 50W 12V* 8000142 48,00 €

notes

Transformer not included/*Trasformatore non compreso*
Maximum supported power/*Potenza massima installabile*: GU5,3 1xMAX 50W Halo (not included)

weight-volume 1,08 kg - 0.010 m³



source **GU10** 1xMAX 50W Halo (not included) D

materials glass, metal/*vetro, metallo*

structure finish	diffuser finish	code	price VAT excluded
chrome/ <i>chromo lucido</i>	crystal/ <i>cristallo</i>	0000990	122,00 €
chrome/ <i>chromo lucido</i>	satin crystal/ <i>bianco satinato</i>	0000994	139,00 €

weight-volume 1,12 kg - 0.010 m³



source **GU10** 1x7W Retrofit **LED MASTER** (not included) A++ / A

materials glass, metal/*vetro, metallo*

structure finish	diffuser finish	code	price VAT excluded
chrome/ <i>chromo lucido</i>	crystal/ <i>cristallo</i>	0000992	139,00 €
chrome/ <i>chromo lucido</i>	satin crystal/ <i>bianco satinato</i>	0000996	139,00 €

notes

LED power max 7W with maximum length of bulb GU10=h 80.5mm/
Potenza LED installabile max 7W con altezza massima lampadina GU10=h 80.5mm

GU 10 LED MASTER

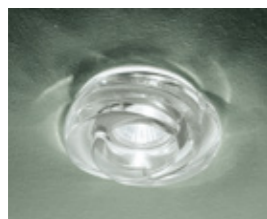
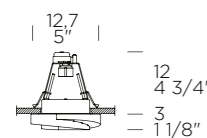

STAR I

Mauro Marzollo, 1991

RECESSED

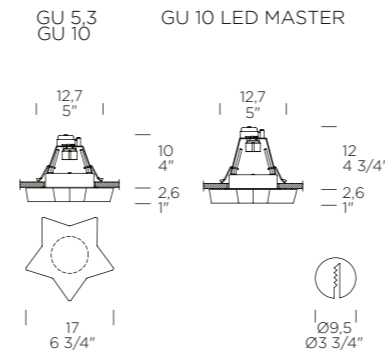

weight-volume 1,15 kg - 0.010 m³

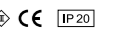

source **GU5,3** 1x8W Retrofit LED (not included) A+ / B

materials glass, metal/*vetro, metallo*

structure finish	diffuser finish	code	price VAT excluded
galvanized metal/ <i>metallo zincato</i>	crystal/ <i>cristallo</i>	0004296	147,00 €
galvanized metal/ <i>metallo zincato</i>	satin crystal/ <i>bianco satinato</i>	0004297	147,00 €

accessories

electronic transformer 50W 12V/*trasformatore elettronico 50W 12V* 8000142 48,00 €

notes

Transformer not included/*Trasformatore non compreso*
Maximum supported power/*Potenza massima installabile*: GU5,3 1xMAX 50W Halo (not included)

weight-volume 1,15 kg - 0.010 m³



source **GU10** 1xMAX 50W Halo (not included) D

materials glass, metal/*vetro, metallo*

structure finish	diffuser finish	code	price VAT excluded
galvanized metal/ <i>metallo zincato</i>	crystal/ <i>cristallo</i>	0004298	139,00 €
galvanized metal/ <i>metallo zincato</i>	satin crystal/ <i>bianco satinato</i>	0004299	139,00 €

weight-volume 1,19 kg - 0.010 m³

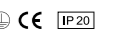

source **GU10** 1x7W Retrofit **LED MASTER** (not included) A++ / A

materials glass, metal/*vetro, metallo*

structure finish	diffuser finish	code	price VAT excluded
galvanized metal/ <i>metallo zincato</i>	crystal/ <i>cristallo</i>	0004302	163,00 €
galvanized metal/ <i>metallo zincato</i>	satin crystal/ <i>bianco satinato</i>	0004303	163,00 €

notes

LED power max 7W with maximum length of bulb GU10=h 80.5mm/
Potenza LED installabile max 7W con altezza massima lampadina GU10=h 80.5mm

STEP I

Mauro Marzollo, 2001

RECESSED

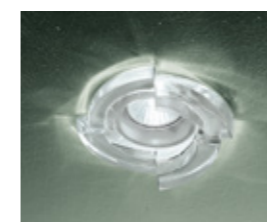
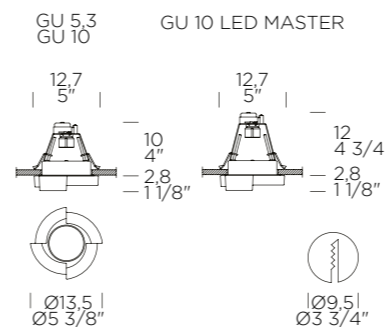

weight-volume 0,88 kg - 0.010 m³

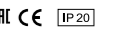

source **GU5,3** 1x8W Retrofit LED (not included) A+ / B

materials glass, metal/*vetro, metallo*

structure finish	diffuser finish	code	price VAT excluded
chrome/ <i>chromo lucido</i>	crystal/ <i>cristallo</i>	0001007	106,00 €
chrome/ <i>chromo lucido</i>	satin crystal/ <i>bianco satinato</i>	0001011	122,00 €

accessories

electronic transformer 50W 12V/*trasformatore elettronico 50W 12V* 8000142 48,00 €

notes

Transformer not included/*Trasformatore non compreso*
Maximum supported power/*Potenza massima installabile*: GU5,3 1xMAX 50W Halo (not included)

weight-volume 0,88 kg - 0.010 m³



source **GU10** 1xMAX 50W Halo (not included) D

materials glass, metal/*vetro, metallo*

structure finish	diffuser finish	code	price VAT excluded
chrome/ <i>chromo lucido</i>	crystal/ <i>cristallo</i>	0001008	122,00 €
chrome/ <i>chromo lucido</i>	satin crystal/ <i>bianco satinato</i>	0001012	130,00 €

weight-volume 0,92 kg - 0.010 m³

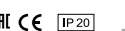

source **GU10** 1x7W Retrofit **LED MASTER** 600lm (not included) A++ / A

materials glass, metal/*vetro, metallo*

structure finish	diffuser finish	code	price VAT excluded
chrome/ <i>chromo lucido</i>	crystal/ <i>cristallo</i>	0001010	139,00 €
chrome/ <i>chromo lucido</i>	satin crystal/ <i>bianco satinato</i>	0001014	147,00 €

notes

LED power max 7W with maximum length of bulb GU10=h 80.5mm/
Potenza LED installabile max 7W con altezza massima lampadina GU10=h 80.5mm

SUN I

Toso, Massari & Associates, 1998

RECESSED

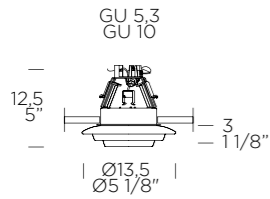

GU 10 LED MASTER

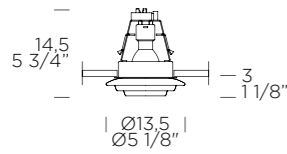

Foro Ø9,5 - Opening Ø3 3/4

weight-volume 0,86 kg - 0.020 m³

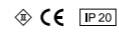

source **GU5,3** 1x8W Retrofit LED (not included) A+ / B

materials glass, metal/*vetro, metallo*

structure finish	diffuser finish	code	price VAT excluded
chrome/ <i>cromo lucido</i>	crystal/ <i>cristallo</i>	0004486	122,00 €
chrome/ <i>cromo lucido</i>	satin crystal/ <i>bianco satinato</i>	0004487	130,00 €

accessories

electronic transformer 50W 12V/*trasformatore elettronico 50W 12V* 8000142 48,00 €

notes

Transformer not included/*Trasformatore non compreso*
Maximum supported power/*Potenza massima installabile*: GU5,3 1xMAX 50W Halo (not included)

weight-volume 0,91 kg - 0.020 m³

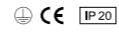

source **GU10** 1xMAX 50W Halo (not included) D

materials glass, metal/*vetro, metallo*

structure finish	diffuser finish	code	price VAT excluded
chrome/ <i>cromo lucido</i>	crystal/ <i>cristallo</i>	0004488	130,00 €
chrome/ <i>cromo lucido</i>	satin crystal/ <i>bianco satinato</i>	0004489	139,00 €

weight-volume 0,91 kg - 0.020 m³



source **GU10** 1x7W Retrofit **LED MASTER** (not included) A++ / A

materials glass, metal/*vetro, metallo*

structure finish	diffuser finish	code	price VAT excluded
chrome/ <i>cromo lucido</i>	crystal/ <i>cristallo</i>	0004484	139,00 €
chrome/ <i>cromo lucido</i>	satin crystal/ <i>bianco satinato</i>	0004485	147,00 €

notes

LED power max 7W with maximum length of bulb GU10=h 80.5mm/
Potenza LED installabile max 7W con altezza massima lampadina GU10=h 80.5mm

VAN 2 I

Roberto Pamio, 1991

RECESSED

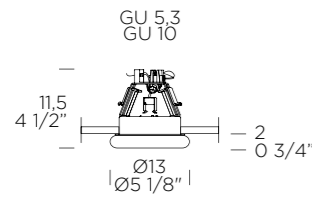

GU 10 LED MASTER

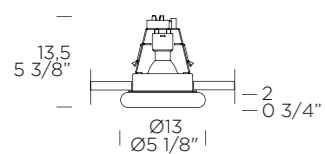

Foro Ø9,5 - opening Ø3 3/4

weight-volume 0,89 kg - 0.020 m³

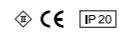

source **GU5,3** 1x8W Retrofit LED (not included) A++ / B

materials glass, metal/*vetro, metallo*

structure finish	diffuser finish	code	price VAT excluded
chrome/ <i>cromo lucido</i>	satin crystal/ <i>bianco satinato</i>	0004276	114,00 €
chrome/ <i>cromo lucido</i>	crystal/ <i>cristallo</i>	0004277	114,00 €

accessories

electronic transformer 50W 12V/*trasformatore elettronico 50W 12V* 8000142 48,00 €

notes

Transformer not included/*Trasformatore non compreso*
Maximum supported power/*Potenza massima installabile*: GU5,3 1xMAX 50W Halo (not included)

weight-volume 0,94 kg - 0.020 m³

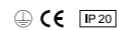

source **GU10** 1xMAX 50W Halo (not included) D

materials glass, metal/*vetro, metallo*

structure finish	diffuser finish	code	price VAT excluded
chrome/ <i>cromo lucido</i>	satin crystal/ <i>bianco satinato</i>	0004278	114,00 €
chrome/ <i>cromo lucido</i>	crystal/ <i>cristallo</i>	0004279	116,00 €

weight-volume 0,94 kg - 0.020 m³



source **GU10** 1x7W Retrofit **LED MASTER** (not included) A++ / A

materials glass, metal/*vetro, metallo*

structure finish	diffuser finish	code	price VAT excluded
chrome/ <i>cromo lucido</i>	satin crystal/ <i>bianco satinato</i>	0004282	130,00 €
chrome/ <i>cromo lucido</i>	crystal/ <i>cristallo</i>	0004283	133,00 €

notes

LED power max 7W with maximum length of bulb GU10=h 80.5mm/
Potenza LED installabile max 7W con altezza massima lampadina GU10=h 80.5mm

SD 802 I

Leucos Design Lab, 2004

RECESSED

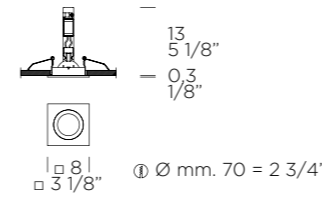

weight-volume 0,5 kg - 0.010 m³

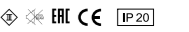

source GU5,3 1x8W Retrofit LED (not included) A++ / B

materials metal/*metallo*

structure finish	diffuser finish	code	price VAT excluded
brushed aluminium/ <i>alluminio spazzolato</i>	brushed aluminium/ <i>alluminio spazzolato</i>	0001083	34,00 €
brushed aluminium/ <i>alluminio spazzolato</i>	white/ <i>bianco</i>	0001085	34,00 €

accessories

concrete form/*cassaforma* SD 802-803 8000110 40,00 €

wiring kit GZ10/*kit cablaggio* GZ10 SD-802 ÷ SD-903 8000159 16,00 €

electronic transformer 50W 12V/*trasformatore elettronico 50W 12V* 8000142 48,00 €

notes

Transformer not included/*Trasformatore non compreso*
Maximum supported power/*Potenza massima installabile*: GU5,3 1xMAX 50W Halo (not included)

SD 803 I

Leucos Design Lab, 2004

RECESSED

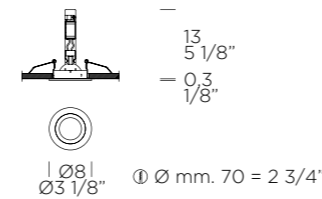

weight-volume 0,5 kg - 0.010 m³



source GU5,3 1x8W Retrofit LED (not included) A++ / B

materials metal/*metallo*

structure finish	diffuser finish	code	price VAT excluded
brushed aluminium/ <i>alluminio spazzolato</i>	brushed aluminium/ <i>alluminio spazzolato</i>	0001087	32,00 €
brushed aluminium/ <i>alluminio spazzolato</i>	white/ <i>bianco</i>	0001089	32,00 €

accessories

concrete form/*cassaforma* SD 802-803 8000110 40,00 €

wiring kit GZ10/*kit cablaggio* GZ10 SD-802 ÷ SD-903 8000159 16,00 €

electronic transformer 50W 12V/*trasformatore elettronico 50W 12V* 8000142 48,00 €

notes

Transformer not included/*Trasformatore non compreso*
Maximum supported power/*Potenza massima installabile*: GU5,3 1xMAX 50W Halo (not included)

SD 902 I

Leucos Design Lab, 2009

RECESSED

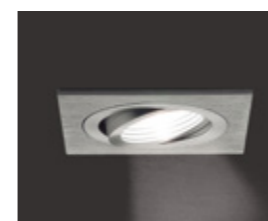
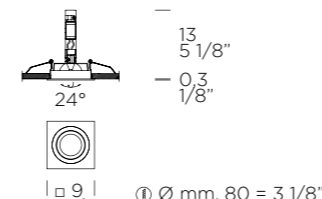

weight-volume 0,5 kg - 0.010 m³



source GU5,3 1x8W Retrofit LED (not included) A++ / B

materials metal/*metallo*

structure finish	diffuser finish	code	price VAT excluded
brushed aluminium/ <i>alluminio spazzolato</i>	brushed aluminium/ <i>alluminio spazzolato</i>	0001092	48,00 €
brushed aluminium/ <i>alluminio spazzolato</i>	white/ <i>bianco</i>	0001096	48,00 €

accessories

concrete form/*cassaforma* SD 902-903 8000111 40,00 €

wiring kit GZ10/*kit cablaggio* GZ10 SD-802 ÷ SD-903 8000159 16,00 €

electronic transformer 50W 12V/*trasformatore elettronico 50W 12V* 8000142 48,00 €

notes

Transformer not included/*Trasformatore non compreso*
Maximum supported power/*Potenza massima installabile*: GU5,3 1xMAX 50W Halo (not included)

SD 903 I

Leucos Design Lab, 2009

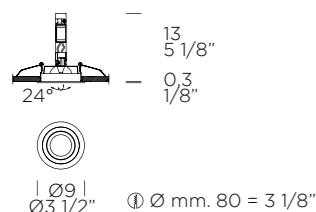
RECESSED**weight-volume** 0,5 kg - 0.010 m³**source** GU5,3 1x8W Retrofit LED (not included) A++ / B**materials** metal/*metallo*

structure finish	diffuser finish	code	price VAT excluded
brushed aluminium/ <i>alluminio spazzolato</i>	brushed aluminium/ <i>alluminio spazzolato</i>	0001098	48,00 €
brushed aluminium/ <i>alluminio spazzolato</i>	white/ <i>bianco</i>	0001102	48,00 €
accessories			
concrete form/ <i>cassaforma</i> SD 902-903		8000111	40,00 €
wiring kit GZ10/ <i>kit cablaggio</i> GZ10 SD-802 ÷ SD-903		8000159	16,00 €
electronic transformer 50W 12V/ <i>trasformatore elettronico</i> 50W 12V		8000142	48,00 €

notes
Transformer not included/*Trasformatore non compreso*
Maximum supported power/*Potenza massima installabile*: GU5,3 1xMAX 50W Halo (not included)

SD 081 N I

Leucos Design Lab, 2011

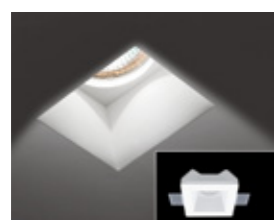
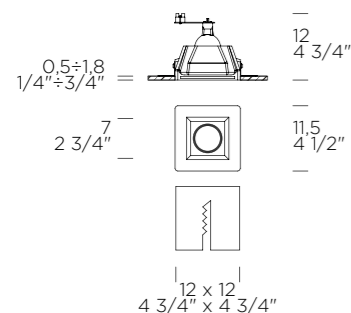
RECESSED**weight-volume** 0,57 kg - 0.010 m³**source** GU5,3 1x8W Retrofit LED (not included) A++ / B**materials** natural plaster, metal

structure finish	diffuser finish	code	price VAT excluded
galvanized metal/ <i>metallo zincato</i>	white/ <i>bianco</i>	0000918	43,00 €
accessories			
mounting box/ <i>cassaforma</i> SD-081 N / SD-081V N		8000112	40,00 €
wiring kit GU10/ <i>kit cablaggio</i> GU10		8000161	24,00 €
electronic transformer 50W 12V/ <i>trasformatore elettronico</i> 50W 12V		8000142	48,00 €

notes
Transformer not included/*Trasformatore non compreso*
Maximum supported power/*Potenza massima installabile*: GU5,3 1xMAX 50W Halo (not included)

SD 081V N I

Leucos Design Lab, 2011

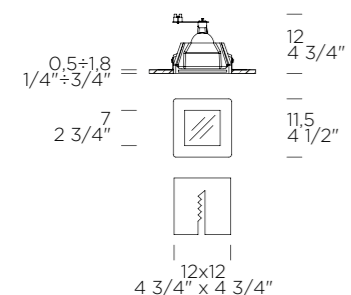
RECESSED**weight-volume** 0,57 kg - 0.010 m³**source** GU5,3 1x8W Retrofit LED (not included) A++ / B**materials** natural plaster, metal/*gesso naturale, metallo*

structure finish	diffuser finish	code	price VAT excluded
galvanized metal/ <i>metallo zincato</i>	white/ <i>bianco</i>	0000920	43,00 €
accessories			
mounting box/ <i>cassaforma</i> SD-081 N / SD-081V N		8000112	40,00 €
wiring kit GU10/ <i>kit cablaggio</i> GU10		8000161	24,00 €
electronic transformer 50W 12V/ <i>trasformatore elettronico</i> 50W 12V		8000142	48,00 €

notes
Transformer not included/*Trasformatore non compreso*
Maximum supported power/*Potenza massima installabile*: GU5,3 1xMAX 50W Halo (not included)

SD 084 N I

Leucos Design Lab, 2011

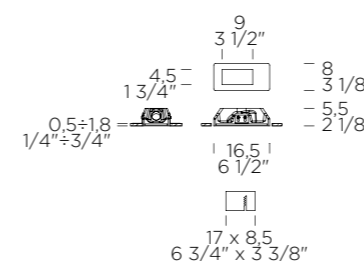
RECESSED**weight-volume** 0,54 kg - 0.010 m³**source** 1x1,2W LED (included) A++ / A **LED****materials** natural plaster, metal/*gesso naturale, metallo*

structure finish	diffuser finish	code	price VAT excluded
galvanized metal/ <i>metallo zincato</i>	white/ <i>bianco</i>	0000917	73,00 €
accessories			
electronic ballast for LED recessed downlight 4W 350MA/ <i>alimentatore elettronico per faretti LED 4W 350MA</i>		8000186	32,00 €
mounting box/ <i>cassaforma</i> SD-084 N		8000115	40,00 €

notes
Electric ballast not included in the mentioned price/*Alimentatore elettronico non compreso nel prezzo*

SD 085 I

Leucos Design Lab, 2009

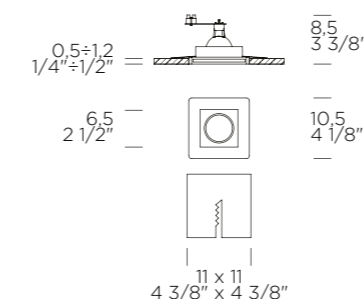
RECESSED**weight-volume** 0,45 kg - 0.010 m³**source** GU5,3 1x8W Retrofit LED (not included) A++ / B**materials** natural plaster, metal/*gesso naturale, metallo*

structure finish	diffuser finish	code	price VAT excluded
galvanized metal/ <i>metallo zincato</i>	white/ <i>bianco</i>	0001250	32,00 €
accessories			
wiring kit GU10/ <i>kit cablaggio</i> GU10		8000161	24,00 €
electronic transformer 50W 12V/ <i>trasformatore elettronico</i> 50W 12V		8000142	48,00 €

notes
Transformer not included/*Trasformatore non compreso*
Maximum supported power/*Potenza massima installabile*: GU5,3 1xMAX 50W Halo (not included)

SD 086 I

Leucos Design Lab, 2009

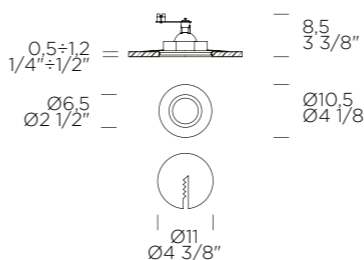
RECESSED**weight-volume** 0,65 kg - 0.010 m³**source** GU5,3 1x8W Retrofit LED (not included) A++ / B**materials** natural plaster, metal/*gesso naturale, metallo*

structure finish	diffuser finish	code	price VAT excluded
galvanized metal/ <i>metallo zincato</i>	white/ <i>bianco</i>	0001252	32,00 €
accessories			
wiring kit GU10/ <i>kit cablaggio</i> GU10		8000161	24,00 €
electronic transformer 50W 12V/ <i>trasformatore elettronico</i> 50W 12V		8000142	48,00 €

notes
Transformer not included/*Trasformatore non compreso*
Maximum supported power/*Potenza massima installabile*: GU5,3 1xMAX 50W Halo (not included)

SD 087 I

Leucos Design Lab, 2009

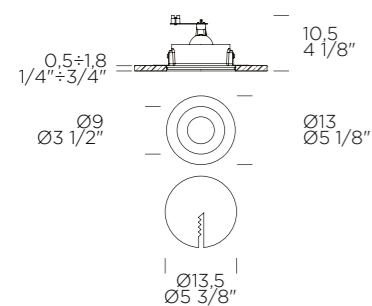
RECESSED**weight-volume** 0,55 kg - 0.010 m³**source** GU5,3 1x8W Retrofit LED (not included) A++ / B**materials** natural plaster, metal/*gesso naturale, metallo*

structure finish	diffuser finish	code	price VAT excluded
galvanized metal/ <i>metallo zincato</i>	white/ <i>bianco</i>	0001254	48,00 €

accessories

wiring kit GU10 / <i>kit cablaggio GU10</i>	8000161	24,00 €
electronic transformer 50W 12V/ <i>trasformatore elettronico 50W 12V</i>	8000142	48,00 €

notesTransformer not included/*Trasformatore non compreso*
Maximum supported power/*Potenza massima installabile*: GU5,3 1xMAX 50W Halo (not included)**SD 087V I**

Leucos Design Lab, 2009

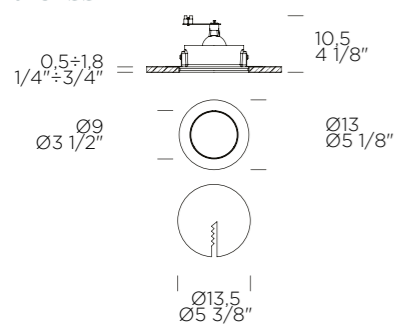
RECESSED**weight-volume** 0,56 kg - 0.010 m³**source** GU5,3 1x8W Retrofit LED (not included) A++ / B**materials** natural plaster, metal/*gesso naturale, metallo*

structure finish	diffuser finish	code	price VAT excluded
galvanized metal/ <i>metallo zincato</i>	white/ <i>bianco</i>	0001256	48,00 €

accessories

wiring kit GU10 / <i>kit cablaggio GU10</i>	8000161	24,00 €
electronic transformer 50W 12V/ <i>trasformatore elettronico 50W 12V</i>	8000142	48,00 €

notesTransformer not included/*Trasformatore non compreso*
Maximum supported power/*Potenza massima installabile*: GU5,3 1xMAX 50W Halo (not included)

COMPOSITIONS AND SPECIAL VERSIONS

COMPOSIZIONI E VERSIONI SPECIALI

REED

Patrick Jouin, 2009

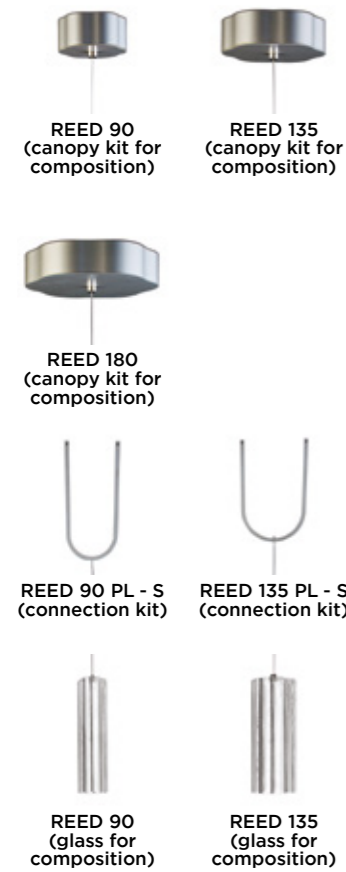

SPECIAL VERSIONS/VERSIONI SPECIALI

REED

Patrick Jouin, 2009



- 1 Grisca Das Hotel, Davos, Switzerland
Architect: Fischbach & Abegg
- 2 Auberge De l'III, Illhaeusern, France
Architect: Jouin Manku Studio
Credits: Eric Laignel



ETHER

Patrick Jouin, 2006



- 1 Bodegas Alion Of Penafiel, Valladolid, Spain
Credits: Fernando Manteca
- 2 Mix Restaurant, Las Vegas, USA
Architect: Jouin Manku Studio
Credits: Eric Laignel
- 3 Van Cleef & Arpels, Paris, France
Architect: Jouin Manku Studio
Credits: Eric Laignel
- 4 YTL Residence, Kuala Lumpur, Malaisie
Architect: Jouin Manku Studio
Credits: Eric Laignel



NIA

Roberto Paoli, 2012

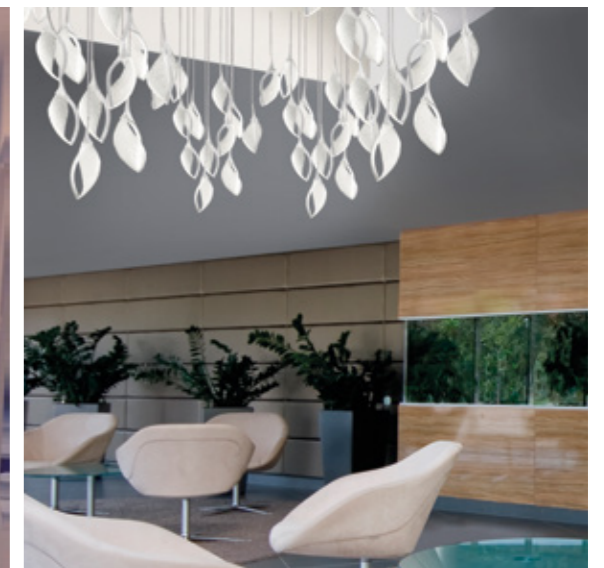
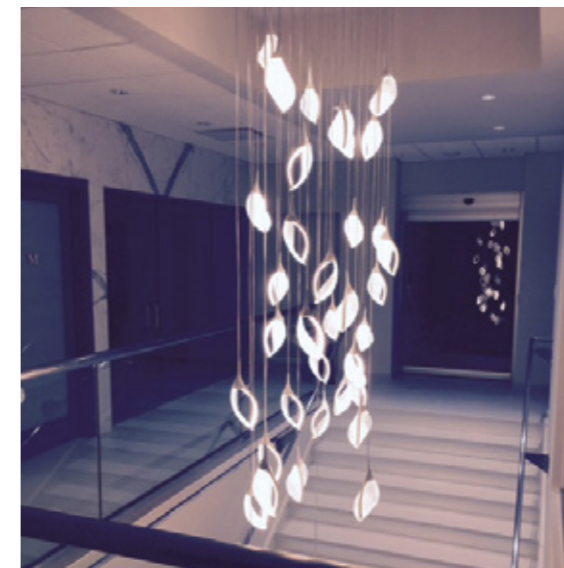

FAIRY

Toso, Massari & Associates With G. Toso, 2009



SPECIAL VERSIONS
VERSIONI SPECIALI

GLÒ

Danilo De Rossi, 2002



1 The Water Club, Atlantic City (NJ), USA
Architect: Lawrence Lee and Associates LA, CA

IXI



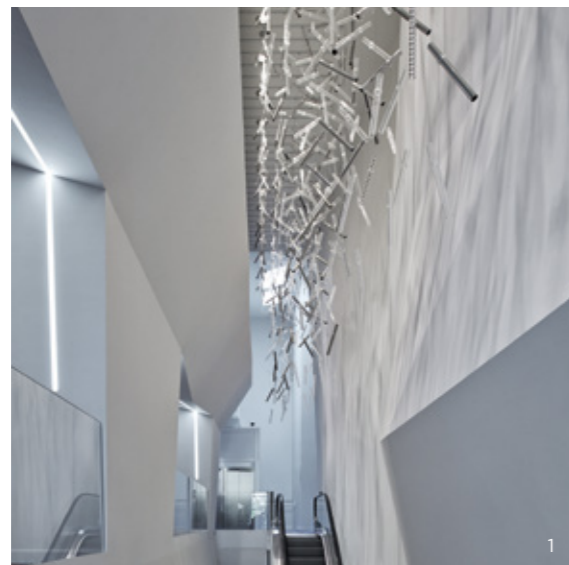





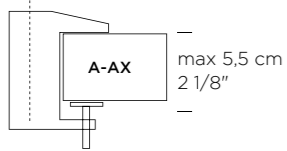

Filippo Caprioglio, 2011

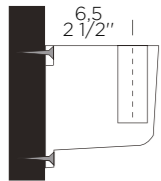

1 Img Cinemas Candiani, Mestre (Venice), Italy
Credits: Paolo Monello
2 Barnett Residence, Lake Minnetonka, MN, USA
Specifier: Alene Workman Interior Design, Ft. Lauderdale, FL
Credits: Karen Melvin

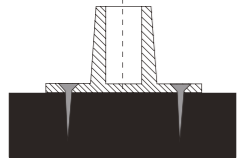
ACCESSORIES

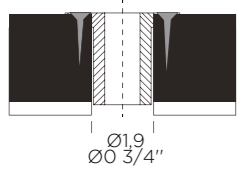
ACCESSORI

JJ T-P	accessories	code	price VAT excluded
bracket/attacco JJ T-P			
	A-AX		
	table bracket gloss white/attacco da tavolo bianco lucido A-AX	8000300	21,00 €
	table bracket matte white/attacco da tavolo bianco opaco A-AX	8000301	21,00 €
	table bracket gloss black/attacco da tavolo nero lucido A-AX	8000302	21,00 €
	table bracket matte black/attacco da tavolo nero opaco A-AX	8000303	21,00 €
	A LUNGO		
	table bracket matte white/attacco da tavolo bianco opaco A LUNGO	8000092	21,00 €
	table bracket matte black/attacco da tavolo nero opaco A LUNGO	8000090	21,00 €
bracket/attacco B LARGE JJ T-P			
			
	wall bracket gloss white/attacco da parete bianco lucido B LARGE	8000266	21,00 €
	wall bracket gloss black/attacco da parete nero lucido B LARGE	8000267	21,00 €
	wall bracket matte white/attacco da parete bianco opaco B LARGE	8000092	21,00 €
	wall bracket matte black/attacco da parete nero opaco B LARGE	8000094	21,00 €
bracket/attacco C JJ T-P			
			
	bracket matte white/attacco bianco opaco C	8000095	21,00 €
	bracket matte black/attacco nero opaco C	8000097	21,00 €
bracket/attacco P JJ T-P			
			
	bracket black/attacco nero P	8000098	7,00

JJ T-P	accessories	code	price VAT excluded
round base/base rotonda JJ T-P			
	round base matte white/base rotonda bianco opaco JJ	8000078	79,00 €
	round base gloss white/base rotonda bianco lucido JJ	8000081	79,00 €
	round base matte black/base rotonda nero opaco JJ	8000080	79,00 €
	round base gloss black/base rotonda nero lucido JJ	8000082	79,00 €

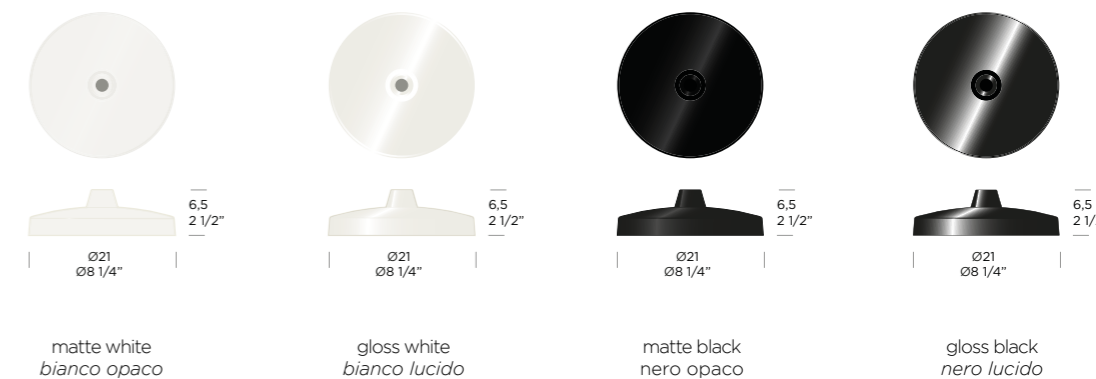

THE GREAT JJ TR

telo The Great JJ TR Outdoor	nylon protective cover item The Great JJ TR Outdoor/ telo di protezione nylon The Great JJ TR Outdoor	8000108	221,00 €
-------------------------------------	--	---------	----------

PRODUCT ACCESSORIES/ACCESSORI PRODOTTO

	accessories	code	price VAT excluded
BOLERO L3-L6			
chain/catena BOLERO L3-L6	chromed chain/catena cromata cm100 BOLERO L3-L6	8000027	32,00 €
ETHER S 90 / S 150			
kit 4 flanges/kit 4 flange ETHER	kit 4 metal flanges for bulb/kit 4 flange magnetiche per LED G53 ETHER S 90/150	8000243	171,00 €
	notes kit 4 flanges valid only for Ether S 90 (codes 0002279 and 0002280) and Ether S 150 (codes 0002361 and 0002362) former versions kit 4 flange valido solo per le precedenti versioni di Ether S 90 (codici 0002279 e 0002280) e Ether S 150 (codici 0002361 e 0002362)		
NIA S			
canopy/rosone NIA S	white canopy ø10 cm for NIA S rosone ø10 cm x 1 calata bianco opaco NIA S	8000144	98,00 €
TRECENTOESSANTAGRADI			
shield/schermo 360°	single aluminium shield for TRECENTOESSANTAGRADI 120 schermo paraluce per TRECENTOESSANTAGRADI 120	8000060	7,00 €
	single aluminium shield for TRECENTOESSANTAGRADI 200 schermo paraluce per TRECENTOESSANTAGRADI 200	8000061	7,00 €

ELECTRONIC BALLASTS AND TRANSFORMERS/ALIMENTATORI E TRASFORMATORI ELETTRONICI

	accessories	code	price VAT excluded
electronic ballast/alimentatore elettronico			
electronic ballast for LED recessed downlight 4W 350MA alimentatore elettronico per faretti LED 4W 350MA		8000186	32,00 €
electronic ballast/alimentatore elettronico 4,2W 24VDC (Nia S)		8000145	40,00 €
electronic ballast/alimentatore elettronico 20W 24VDC (Nia S 3 - S 6)		8000146	57,00 €
electronic ballast/alimentatore elettronico 60W 24VDC (Nia S 12)		8000147	89,00 €
electronic transformer/trasformatore elettronico	electronic transformer 50W 12V/trasformatore elettronico 50W 12V	8000142	48,00 €

KIT

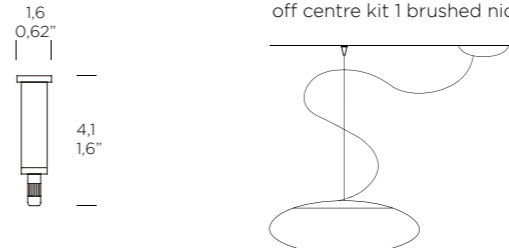
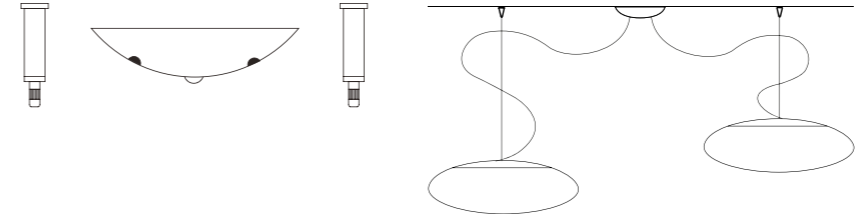
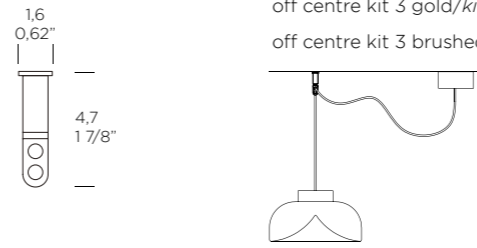
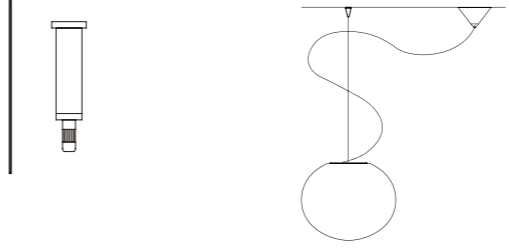
	accessories	code	price VAT excluded
off centre kit 1/kit 1 per decentramento	off centre kit 1 chrome/kit 1 per decentramento cromato off centre kit 1 brushed nickel/kit 1 per decentramento nickel satinato	8000150 8000151	16,00 € 16,00 €
			
off centre kit 2/kit 2 per decentramento	off centre kit 2 brushed nickel/kit 2 per decentramento nickel satinato off centre kit 2 chrome/kit 2 per decentramento cromato	8000136 8000135	81,00 € 89,00 €
			
off centre kit 3/kit 3 per decentramento	off centre kit 3 chrome/kit 3 per decentramento cromato off centre kit 3 gold/kit 3 per decentramento dorato off centre kit 3 brushed nickel/kit 3 per decentramento nickel satinato	8000152 8000137 8000153	16,00 € 16,00 € 16,00 €
			
off centre kit 4/kit 4 per decentramento	off centre kit 4 chrome/kit 4 per decentramento cromato off centre kit 4 brushed nickel/kit 4 per decentramento nickel satinato	8000154 8000155	24,00 € 24,00 €
			
wiring kit/kit cablaggio	wiring kit/kit cablaggio GZ10 for downlights SD 802 ÷ 903	8000159	16,00 €
	compatible bulbs (not included): lampadine compatibili (non include): 1x50W GZ 10 1x11W GU 10 MEGAMAN 1x7W GU 10 MASTERLED		
wiring kit/kit cablaggio	wiring kit/kit cablaggio GU10 for downlights SD 081 N ÷ SD 087 V	8000161	24,00 €
	compatible bulbs (not included): lampadine compatibili (non include): 1x50W GU 10 1x7/11W GU 10 MEGAMAN 1x7W GU 10 MASTERLED		
dimmer kit	dimmer kit AKI/FLECHA S	8000148	122,00 €
swang inclination kit/kit inclinazione	swang inclination kit/kit inclinazione A BEAMER S swang inclination kit/kit inclinazione R BEAMER S	8000149 8000164	48,00 € 48,00 €
receiver kit/kit ricevitore	receiver + remote control kit for LED light sources IXI S kit ricevitore + telecomando fonti luminose LED IXI S	8000143	532,00 €

SD-081 N/SD-081V N

mounting box/cassaforma SD-081 N/SD-081V N

8000112

40,00 €

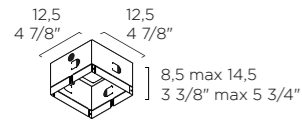

SD-084 N

mounting box/cassaforma SD-084 N

8000115

40,00 €

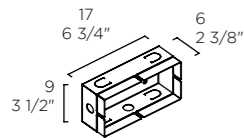

SD-802-803

concrete form/cassaforma SD 802-803

8000110

40,00 €

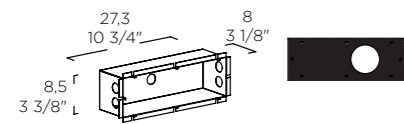

SD-902-903

concrete form/cassaforma SD 902-903

8000111

40,00 €

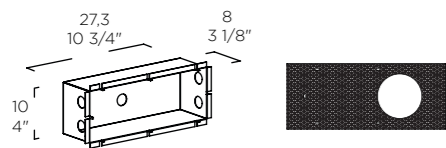

FINISHES GLOSSARY

GLOSSARIO FINITURE



AMBER
AMBRA



BLACK SFUMATO
NERO SFUMATO



BRUSHED NICKEL
NICHEL SPAZZOLATO



CAPPADOCIA GOLD
ORO CAPPADOCIA

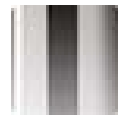

CHROME SFUMATO
CROMO SFUMATO

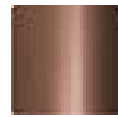

COPPER
RAME



GLOSS BLACK
NERO LUCIDO



GLOSS WHITE
BIANCO LUCIDO



GREY
GRIGIO



LIGHT GREY
GRIGIO CHIARO



GOLD
DORATO LUCIDO



GUNMETAL
CANNA DI FUCILE



ANODIZED ALUMINIUM
ALUMINIO ANODIZZATO



AQUAMARINE
ACQUAMARINA



BRUSHED STEEL
ACCIAIO SPAZZOLATO



CARRARA MARBLE
MARMO DI CARRARA



CHROMED
CROMATO



AMBER/AMBER GRANIGLIA
AMBRA/AMBRA GRANIGLIA



ANTHRACITE
ANTRACITE



BLACK
NERO



BLEACHED BEECH
FAGGIO SBIANCATO



BRUSHED ALUMINIUM
ALLUMINIO SPAZZOLATO

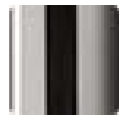

CHROME
CROMATO

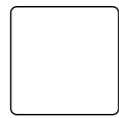

CRYSTAL
CRISTALLO

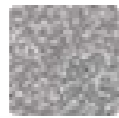

GALVANIZED METAL
METALLO ZINCATO



GLOSS HONEY
GIALLO PAGLIERINO

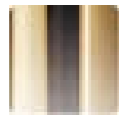

GOLD SFUMATO
ORO SFUMATO

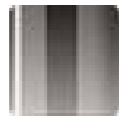

GUNMETAL SFUMATO
CANNA DI FUCILE SFUMATO



MOCHA
MOKA



NATURAL CARBON FIBER
FIBRA DI CARBONIO NATURALE

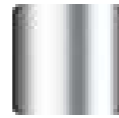

POLISHED ALUMINIUM
ALLUMINIO LUCIDO

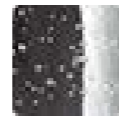

PULEGOSO/MIRRORED
PULEGOSO/SPECCHIO



ROSE GOLD SFUMATO
ORO ROSA SFUMATO



SATIN STEEL
ACCIAIO SATINATO



SMOKE GREY, WHITE, AMBER,
TOBACCO, WHITE, AMBER
FUMÉ, BIANCO AMBRA,
TABACCO, BIANCO, AMBRA



TITANIUM
TITANIO

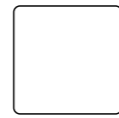

TRANSPARENT
TRASPARENTE



TRANSPARENT SILKY WHITE
BIANCO SETA



MIRROR
SPECCHIO

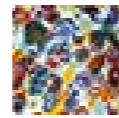

MULTICOLORED MURRINE
MURRINE MULTICOLORE



MULTICOLOR
MULTICOLORE



NATURAL OKOUME
OKUMÉ NATURALE

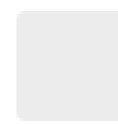

SATIN CRYSTAL
CRISTALLO SATINATO



SILVER
ARGENTO



SMOKE GREY, WHITE, SMOKE
GREY, WHITE, MIRROR
FUMÉ, BIANCO,
FUMÉ, BIANCO, SPECCHIO



TITANIUM GREY
GRIGIO TITANIO

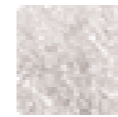

TRANSPARENT/SILVER LEAF
TRASPARENTE/FOGLIA ARGENTO

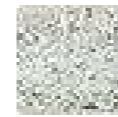

TRANSPARENT/GRANIGLIA
TRASPARENTE/GRANIGLIA

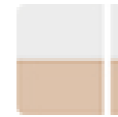

OFF: GLOSS WHITE, ON: SHADES
OF SAND
SPENTO-BIANCO LUCIDO,
ACCESO-NUANCE SABBIA



PLATINUM
PLATINO



POLISHED STEEL
ACCIAIO LUCIDO



SATIN NICKEL
NICKEL SATINATO



SMOKE GREY
FUMÉ



TEXTURED BLACK RAL 9004
NERO RAGGRINZANTE RAL 9004



TITANIUM GREY SFUMATO
GRIGIO TITANIO SFUMATO



TRANSPARENT BLACK
NERO TRASPARENTE

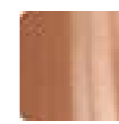

VARNISHED BRUSHED COPPER
RAME NATURALE SPAZZOLATO
VERNICIATO TRASPARENTE



WHITE
BIANCO



WHITE ONYX
ONICE BIANCO

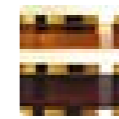

WHITE, GOLD, TRANSPARENT
SMOKE, WHITE, GOLD, BLACK
BIANCO, ORO, FUMÉ, BIANCO,
ORO, NERO



WHITE, ORANGE, TRANSPARENT,
WHITE, ORANGE, MIRROR
BIANCO, ARANCIO, TRASPARENTE,
BIANCO, ARANCIO, SPECCHIO



During 2018 the company renewed the certification for its quality control system in conformity with UNI EN ISO 9001:2015 standards. This evidence how the company processes and their interaction are all carried out to the strictest quality control standards for the products, service and customer satisfaction, which are priorities in all the company activities.

Nel 2018 l'azienda ha rinnovato la certificazione del sistema di gestione della qualità, operando in conformità ai requisiti della norma UNI EN ISO 9001: 2015. A testimonianza di come i processi aziendali e le loro interazioni si svolgono sempre secondo gli stessi rigorosi criteri, atti a garantire la qualità dei prodotti, dei servizi e la soddisfazione dei clienti, considerandoli interlocutori primari delle attività svolte.

CERTIFICATIONS AND TRADE MARKS/CERTIFICAZIONI E MARCHI

Our lighting fixtures are wired according to Class I specifications. Additional safety precautions against electric shocks are provided besides the insulation of the incoming feeder. All touchable metal components are connected to the grounding. Fixtures wired according to Class II are provided with double insulation, without grounding, while the Class III ones are safe because of the low voltage. High thermic resistance wires are used and halogen bulbs are fitted with glass protector. Epoxidic powders lacquering to guarantee perfect scratch resistance. For easier cleaning of glass diffusors some lukewarm water with vinegar is recommended.

Nei nostri apparecchi, cablati secondo le norme relative alla classe I, la protezione contro le folgorazioni si basa, oltre che sull'isolamento del cavo di alimentazione, su una misura di sicurezza supplementare, costituita dal collegamento delle parti metalliche accessibili ad un conduttore di protezione (messa a terra), in modo che tali parti non possano in ogni caso divenire pericolose. Nel caso di apparecchi cablati in classe II, la protezione viene garantita da misure di sicurezza supplementari, costituite da un doppio isolamento delle parti in tensione. Queste misure non comportano l'adozione di dispositivi per la messa a terra. Gli apparecchi appartenenti alla classe III basano la propria sicurezza sull'adozione di una tensione di alimentazione estremamente bassa. I nostri apparecchi sono corredati da cavi ad alta resistenza termica e, in ottemperanza alle norme di sicurezza contro lo scoppio delle lampadine alogene lineare, da schermi protettivi in pyrex. Le laccature sono eseguite con polveri epossidiche essiccate in forni ad alta temperatura, metodo che garantisce la massima resistenza ad urti ed abrasioni. Per facilitare le normali operazioni di pulizia dei vetri, consigliamo una soluzione di acqua tiepida ed aceto.



This mark guarantees that the product has passed all the tests established for electrical safety standards by the European Community
Questo marchio indica che il prodotto ha superato positivamente tutte le prove previste dalle normative per la sicurezza elettrica, richieste dalla Comunità Europea. Normative EN 60598-1 corrispondenti alle norme Italiane per la sicurezza elettrica CEI 34-21



This marking is used on products for export to the russian, Belarusian, kazakh market, which guarantees that the product conforms to the safety requirements of these countries
Questa marcatura e utilizzata per prodotti diretti al mercato russo, bielorusso, kazaco. Garantisce la conformità del prodotto ai requisiti di sicurezza: Russia, Bielorussia, Kazakistan



FIXTURE CLASS I - Safety is guaranteed when earthed
APPARECCHIO IN CLASSE I - La sicurezza viene garantita con la messa a terra



FIXTURE CLASS II - A fixture where protection against electric shock does not rely only on the main insulation but also further safety measures involving double insulation or reinforced insulation

APPARECCHIO IN CLASSE II - Apparecchio nel quale la protezione contro la scossa elettrica non si basa unicamente sull'isolamento principale ma anche sulle misure supplementari di sicurezza costituite dal doppio isolamento o dall'isolamento rinforzato.



FIXTURE CLASS III - A fixture where protection against electric shock depends on the very low and safe voltage supply, guaranteeing no higher voltage levels are generated. N.B. a Class III fixture does not necessarily require grounding protection

APPARECCHIO IN CLASSE III - Apparecchio in cui la protezione contro la scossa elettrica si basa sull'alimentazione a bassissima tensione di sicurezza e in cui non si generano tensioni superiori alla stessa.
Nota: un'apparecchio in classe III non deve essere provvisto di messa a terra di protezione



INDEX PROTECTION - A symbol that identifies the protection index against solid particles or liquids entering the fixture.
GRADO DI PROTEZIONE - Simbolo che identifica la classificazione secondo il grado di protezione contro la penetrazione di corpi solidi e liquidi



NOT COOL BEAM - Do not use cool beam light bulbs
NOT COOL BEAM - Divieto d'uso di lampade a luce fredda

LEUCOS su reserves the right to modify at any time without notice the technical and aesthetic characteristics of the elements printed in this price list

The colours shown in the price list are an indication only

Regardless of the patent protection, designs and patterns produced by LEUCOS and reported in this price list are protected by copyright

The registered brands quoted in the price list are the exclusive property of their respective owners

All technical details referring to the Retrofit LED 'wattage' are an indication only

Due to the ever-changing improvements of technology, Leucos srl reserves the right to update both the list of available products and their technical characteristics

It is forbidden to reproduce any part of this price list

LEUCOS su si riserva la facoltà di modificare in qualunque momento e senza preavviso le caratteristiche tecniche ed estetiche degli elementi illustrati nel presente listino

I colori riprodotti nel listino sono indicativi

Indipendentemente dalla tutela brevettuale, i disegni ed i modelli prodotti da LEUCOS e riportati in questo listino sono da considerarsi protetti da diritto di autore

I marchi registrati in questo listino sono di esclusiva proprietà dei rispettivi proprietari

I dati tecnici "wattaggio" riferiti alla sorgente Retrofit LED sono puramente indicativi

Stante la continua evoluzione delle tecnologie, Leucos srl si riserva di aggiornare sia la lista dei prodotti disponibili che le caratteristiche tecniche degli stessi.

È vietata la riproduzione anche parziale di questo listino



The list prices are not inclusive of the charges introduced by the law by decree dated 25th July 2005, n. 151 (Regulations 2002/95/CE, 2002/96/CE e 2003/108/CE relative to the use reduction of dangerous substances in the electrical and electronic equipment (AEE) as well as to the waste disposal). WEEE: Waste of electrical and electronic equipment

I prezzi indicati nel presente listino sono esclusi da oneri introdotti dal decreto legislativo 25 luglio 2005, n. 151 (attuazione delle direttive 2002/95/CE, 2002/96/CE e 2003/108/CE, relative alla riduzione dell'uso di sostanze pericolose nelle apparecchiature elettriche ed elettroniche (AEE), nonché allo smaltimento dei rifiuti). RAEE: Rifiuti di apparecchi elettrici ed elettronici = WEEE: Waste of electrical and electronic equipment.



According to the Commission Regulation (UE) N. 874/2012, from 1st march 2014 energy consumption labels are available at www.leucos.com

In base al Regolamento Delegato (UE) N. 874/2012, dal 1 marzo 2014 sono disponibili le etichette indicanti il consumo energetico al sito www.leucos.com

GENERAL TERMS AND CONDITIONS OF SALE

ART. 1 - GENERAL ASPECTS

1.1 The terms and conditions set out hereunder (the “LEUCOS General Terms and Conditions of Sale”) are an integral part of the offers and/or proposals made by Leucos (hereinafter “Seller”) and of the contracts concluded between Seller and any purchaser (hereinafter “Purchaser”) concerning the sale of lighting devices and components, available in the collections bearing the LEUCOS trademark and included in the related catalog, as created and modified from time to time (hereinafter the “Products”).

1.2 The LEUCOS General Terms and Conditions of Sale shall apply to all transactions concluded between Seller and Purchaser, without the need for an express reference thereto or for a specific agreement to this effect upon the conclusion of each transaction. All other terms and conditions shall only apply where confirmed in writing by Seller.

1.3 Seller reserves the right to amend, add to or vary the LEUCOS General Terms and Conditions of Sale, appending such variations to the offers or any correspondence sent to Purchaser in writing.

ART. 2 - PRODUCT AVAILABILITY

2.1 Purchaser is aware and accepts that the Products shall be solely those available when the contract is concluded and/or the order is confirmed by Seller.

2.2 Seller reserves the right not to fill an order if the Products can no longer be manufactured or supplied for any reason.

ART. 3 - CONCLUSION OF THE CONTRACT

3.1 Contracts governing the supply of Products shall be considered concluded when Purchaser receives confirmation of its order from Seller.

3.2 Orders and order confirmations must be drafted in written form and signed by Purchaser and may also be sent by fax or e-mail.

3.3 If an order is preceded by an offer by Seller, Purchaser must refer thereto for the issue of the order, it being understood, in any event, that the terms and conditions of supply specified in the offer shall become binding for Seller only if, and to the extent that, the order is subsequently confirmed by Seller in writing.

3.4 Orders and/or modifications of orders made orally or over the telephone shall be confirmed in writing by Purchaser, which shall then receive the pertinent order confirmation from Seller. If this does not occur, Seller assumes no liability for any errors or possible misunderstandings.

3.5 Purchaser shall be liable for the costs of any modifications or transformations to be applied to the Products, where possible.

3.6 Where the purchase and sale contracts provide for multiple deliveries over time, Seller reserves the right to make all modifications of an aesthetic, size and technical nature to the Products that prove necessary or appropriate, in accordance with their functional characteristics and applicable legislation, without this entitling Purchaser to make any demands or claims or any kind.

ART. 4 - PRICES AND PAYMENTS

4.1 Unless otherwise agreed, prices are stated in euro, inclusive of packaging, but exclusive of VAT, indirect taxes, excise taxes and any taxes for which Purchaser is liable, which shall be paid by the latter. In the event of exemption, Purchaser shall provide Seller with the appropriate documentation.

4.2 Seller may modify the prices of the Products at any time as a consequence of an increase in the costs of raw materials and labor. However, the Products shall not be delivered or offered at increased prices without prior notice.

4.3 Unless otherwise agreed, payments shall be made on Seller’s premises, in accordance with the agreed terms and conditions. The terms of payment shall begin to run from the date of the invoice.

4.5 In the event of agreed partial returns, the goods shall nonetheless be paid for in full. After receiving the payment from Purchaser, Seller shall issue a credit note for the return received in accordance with the same terms and conditions of payment applied to Purchaser in the contract.

ART. 5 - NON-PAYMENT OR DELAYED PAYMENT

5.1 Payments may not be delayed and/or withheld for any reason. Any complaints or claims shall not give rise to the right to refuse payment or to offsetting.

5.2 Notwithstanding all rights granted to Seller, in the event of delayed payment or non-payment according to the agreed terms, or of refusal to accept delivery of the Products purchased, and without prejudice to rights relating to ownership:

- late payment interest shall apply, in accordance with Legislative Decree 231/2002, with effect from the date on which the payment comes due;
- Seller may suspend delivery of the Products, suspend the warranty until resumption of payment, without prejudice to the applicable due date, and allocate the sums previously received to the accounts past due;
- the acceleration clause having come into effect, Seller shall be entitled to demand immediate payment of the residual amount due.

ART. 6 - DELIVERY TERMS

6.1 Unless otherwise agreed in writing, no delivery term indicated shall be binding for Seller. Unless otherwise agreed between the parties, delivery terms shall be indicative, as stated in the order confirmation.

6.2 Any liability relating to deliveries deriving from force majeure or other unforeseeable events – including, without limitation, those set out in Art. 12 hereunder – not attributable to Seller shall release Seller from its obligation to comply with the agreed delivery term, even if binding.

6.3 Regardless of the agreed delivery terms (carriage paid to designated port or carriage forward) and of shipping and insurance costs, delivery shall be considered to have been made, and risks transferred accordingly, in all cases and for all intents and purposes, when the goods are loaded onto the vehicle at the moment of departure from Seller’s facility.

6.4 If Purchaser does not collect the Products or accept delivery thereof, Seller shall be entitled, once 15 days have elapsed from notice, and without prejudice to the legal remedies, to terminate the contract and resell the Products not collected, informing Purchaser or the terms and conditions of sale, while definitively retaining the the advance and any installments of the price already paid by the Client, by way of penalty. The difference between the contractual price (plus the costs of storage and safekeeping) and the proceeds of resale to third parties shall be due from Client, and late payment interest shall accrue on this amount at the rate specified in Art. 5.2 a). The foregoing is without prejudice to Seller’s right to compensation for any additional damages suffered.

ART. 7 - RETENTION OF TITLE AND TRANSFER OF RISKS

7.1 Seller shall retain title to the Products until they have been paid for in full, along with all additional costs.

7.2 Once delivery has been made, Purchaser shall be liable for all damages that the Products may suffer or cause.

7.3 Until payment in full, the Products may not be resold without Seller’s prior written consent.

ART. 8 - WARRANTY TERMS

8.1 The Products are manufactured in accordance with applicable legislation and Seller offers a warranty for a period of 24 (twenty-four) months from the date of delivery.

8.2 All defects shall be reported according to the conditions indicated in Art. 14 below within eight (8) days of the date of delivery. In the event of latent defects, the period of eight (8) days begins when the defects are discovered.

8.3 If Purchaser is a “Consumer” as defined in Art. 3 of the Consumer Code (Legislative Decree 206/2005), any defects of conformity of the Product must be reported within two (2) months of discovery.

8.4 Seller shall not be liable for any defect in the Products due to drawings, designs or technical specifications provided by Purchaser, or for defects due to wear and tear, inappropriate or improper storage or use, negligence or unskilled use, tampering with or alteration of the Products by Purchaser or by third parties.

8.5 Seller shall not be liable for damages or losses of any kind or nature suffered by part or all of the Products during shipment, regardless of whether shipment is provided by a carrier engaged by third parties, by Purchaser or by Seller, which in this latter case renders no warranty in respect thereof, and shall be released from its delivery obligation by simply delivering the goods to the carrier.

8.6 If a complaint of flaws or defects proves to be justified, the warranty shall be limited to replacement or repair of the defective Products or components, expressly excluding any termination of the contract, reduction of the price, suspension of payment or suspension of the warranty. Replacement of the defective Products shall be at Seller’s discretion, following inspection in its laboratories.

ART. 9 - LIMITATION OF LIABILITY

9.1 Seller shall not be liable for direct, indirect and consequential damages, without any limitation whatsoever, suffered by property or persons during the use and/or maintenance of the Products sold. In such cases, Purchaser shall hold Seller harmless and immune from any claims, actions, procedures and/or complaints by harmed third parties against Seller.

9.2 In any event, Seller’s liability shall be limited to the cost of the defective products that gave rise to this liability, as quantified by the net price invoiced to Purchaser.

ART. 10 - INDUSTRIAL AND INTELLECTUAL PROPERTY RIGHTS

10.1 Trademarks, patents, designs, plans, prototypes, industrial secrets, know-how and all related industrial and intellectual property rights shall be the sole property of LEUCOS and shall remain its property ever after the sale of the Products.

10.2 Purchaser must obtain Seller’s prior written permission in order to use Seller’s trademarks and/or signs in its activities.

ART. 11 - TERMINATION

11.1 If Purchaser fails to make payment within the prescribed term or commits an ongoing or serious breach, without remedying it within 30 (thirty) business days from the date of notice to perform sent by LEUCOS, Seller may terminate the contract immediately, without prejudice to any further rights.

11.2 In any event, LEUCOS may terminate the contract immediately in the event of a bankruptcy declaration concerning Purchaser, liquidation, suspension of payments, attachment, insolvency or any other situation that may affect performance by Purchaser.

ART. 12 - FORCE MAJEURE

12.1 If performance of the contract or of any other obligation (other than payment) is obstructed, limited or prevented by events of force majeure that persist for more than three (3) months, each party may terminate the contract, without any liability.

12.2 “Event of force majeure” is defined as any event that is beyond the reasonable control of the interested party, including, without limitation, strikes, lock-ins, boycotts, wars, insurrections, civil wars, acts of vandalism, compliance with laws or government orders, statutes, provisions or directives, accidents, breakdowns of plants or machinery, fires, floods, difficulties, increases in labor or shipping costs or any other circumstances capable of jeopardizing the supply of the Products.

12.3 The interested party shall inform the other party directly of the occurrence of the event of force majeure of which it has become aware and that it believes may jeopardize the performance of the contract.

ART. 13 - PROCESSING OF PERSONAL DATA

13.1 Purchaser’s personal data shall be processed in accordance with Italian legislation governing the processing of personal data (Legislative Decree 196/2003). Seller informs Purchaser that Seller is the data controller and that Purchaser’s data shall be collected and processed solely for the performance of the contract.

13.2 Refer to the privacy policy statement on the website www.leucos.com for any further information.

ART. 14 - COMMUNICATIONS

With the exception of information of an operational nature, all communications shall be sent in writing, by fax, registered mail with return receipt, certified e-mail (PEC) or express courier to:
-registered office- CLANN srl, via del Commercio 22, 36060 Romano d’Ezzelino (VI) ITALY
-operational headquarter- LEUCOS a brand of Clann srl, via del Lavoro 22, 30030 Salzano (VE) ITALY
- PEC: clannsril@legalmail.it

ART. 15 - APPLICABLE LAW AND COURT OF JURISDICTION

15.1 These LEUCOS General Terms and Conditions of Sale, all related purchase and sale contracts and all matters that derive herefrom or are related hereto, shall be governed, construed and implemented in accordance with the laws and regulations in effect in Italy, with the express exclusion of the the Vienna Convention on the International Sale of Goods 1980.

15.2 Any disputes that arise between the parties in connection with the interpretation, validity and performance of these LEUCOS General Terms and Conditions of Sale and the related contracts entered into shall come before the sole jurisdiction of the Court of Venice, to the exclusion of all other courts.

15.3 It is understood that only Seller, at its discretion, shall be entitled to waive the jurisdiction of the sole court of jurisdiction, as defined in Art. 15.2 above, in order to take legal action against Purchaser, in its domicile and before the Court with jurisdiction there.

ART. 16 - FINAL PROVISIONS

16.1 The rights and obligations deriving from these LEUCOS General Terms and Conditions of Sale and related purchase and sale contracts may not be assigned without Seller’s prior written consent.

16.2 The invalidity of part or all of the provisions of these LEUCOS General Terms and Conditions of Sale shall not undermine the validity of the remaining provisions.

16.3 The rights and remedies of LEUCOS provided for in these LEUCOS General Terms and Conditions of Sale shall not jeopardize any other right or remedy available according to applicable law.

16.4 Any failure to exercise, or delayed exercise, by LEUCOS of its rights shall not constitute waiver or forfeiture of such rights.

16.5 Under no circumstances may the headings of the articles of these LEUCOS General Terms and Conditions be construed as limiting or extending the scope of the content of the particular sections to which they refer.

16.6 These LEUCOS General Terms and Conditions of Sale have been drafted in both Italian and English language versions. In the event of interpretative doubts, the version in Italian shall prevail.

16.7 These LEUCOS General Terms and Conditions of Sale shall enter into effect on January 1, 2018 and shall supersede previous versions.

16.8 Where justified, returns of goods must nonetheless be authorized in writing by Seller’s sales office, which shall issue the instructions to be followed.

The LEUCOS General Terms and Conditions of Sale and related purchase and sale contracts may not be assigned without Seller’s prior written consent.

16.9 The invalidity of part or all of the provisions of these LEUCOS General Terms and Conditions of Sale shall not undermine the validity of the remaining provisions.

Purchase to Articles 1341 and 1342 of the Italian Civil Code, Purchaser declares that it expressly approves the following clauses of the LEUCOS General Terms and Conditions of Sale: 1.3 (general aspects); 3 (conclusion of the contract); 6 (delivery terms); 8.5 - 8.6 (warranty terms); 9 (limitation of liability); 15 (applicable law and court of jurisdiction); and 16 (final provisions).

CONDIZIONI GENERALI DI VENDITA

ART. 1 - ASPETTI GENERALI

1.1 I termini e le condizioni qui di seguito indicati (le “Condizioni Generali di Vendita LEUCOS”) formano parte integrante delle offerte e/o proposte formulate da Leucos (di seguito “Venditore”) e dei contratti conclusi tra il Venditore e qualsivoglia Acquirente (di seguito “Acquirente”) riguardanti la vendita di apparecchi di illuminazione e componenti, disponibili nelle collezioni contrassegnate dal marchio LEUCOS e presenti nel relativo catalogo, di volta in volta creati e modificati (di seguito i “Prodotti”).

1.2 Le Condizioni Generali di Vendita LEUCOS si applicano a tutte le transazioni concluse tra il Venditore e l’Acquirente senza necessità che vi sia un espresso richiamo alle stesse o uno specifico accordo in tal senso alla conclusione di ogni singola transazione. Qualsiasi condizione o termine differente trova applicazione soltanto se confermato per iscritto da parte del Venditore.

1.3 Il Venditore si riserva il diritto di modificare, integrare o variare le Condizioni Generali di Vendita LEUCOS, allegando tali variazioni alle offerte ovvero a qualsivoglia corrispondenza inviata per iscritto all’Acquirente.

ART. 2 - DISPONIBILITA' PRODOTTI

2.1 L’ Acquirente è consapevole ed accetta che i Prodotti siano esclusivamente quelli disponibili al momento della conclusione del contratto e/o della conferma dell’ordine da parte del Venditore.

2.2 Il Venditore si riserva il diritto di non evadere l’ordine nel caso in cui i Prodotti non possano più, per qualunque motivo, essere fabbricati o forniti.

ART. 3 - CONCLUSIONE DEL CONTRATTO

3.1 Il contratto avente ad oggetto la fornitura dei Prodotti si intende concluso nel momento in cui l’Acquirente riceve dal Venditore la conferma del proprio ordine.

3.2 Gli ordini e le conferme d’ordine devono essere necessariamente redatti in forma scritta e sottoscritti dall’Acquirente e possono essere trasmessi anche a mezzo fax o posta elettronica.

3.3 Qualora l’ordine sia preceduto da un’offerta del Venditore, l’Acquirente dovrà fare riferimento ad essa per l’emissione dell’ordine, fermo restando che, in ogni caso, i termini e le condizioni di fornitura specificati nell’offerta diventeranno vincolanti per il Venditore solo se e nei limiti in cui l’ordine venga successivamente confermato per iscritto dal medesimo.

3.4 Gli ordini e/o le modifiche di ordini effettuati verbalmente o telefonicamente devono essere confermati per iscritto dall’Acquirente che riceverà, a sua volta, la relativa conferma d’ordine da parte del Venditore. In caso contrario il Venditore non si assume alcuna responsabilità con riguardo a eventuali errori o possibili fraintendimenti.

3.5 I costi relativi ad eventuali modifiche o trasformazioni da eseguirsi sui Prodotti, laddove possibili, saranno a carico dell’Acquirente.

3.6 Laddove i contratti di compravendita prevedano più consegne nel tempo, il Venditore si riserva la facoltà di apportare ai Prodotti tutte le modifiche di natura estetica, dimensionale e tecnica che, nel rispetto delle relative caratteristiche funzionali e della normativa vigente, dovessero rendersi necessarie od opportune, senza che per ciò l’Acquirente possa avanzare pretese o reclami di alcun tipo.

ART. 4 - PREZZI E PAGAMENTI

4.1 Salvo diversa pattuizione, i prezzi sono indicati in Euro, comprensivi di imballaggio, con esclusione di IVA, imposte indirette, tasse, accise, così come qualsivoglia imposta a carico dell’Acquirente che sarà corrisposta da quest’ultimo; in caso di esenzione, l’Acquirente fornirà al Venditore appropriata documentazione.

4.2 Il Venditore potrà in qualsiasi momento modificare i prezzi dei Prodotti in conseguenza dell’aumento di costi delle materie prime e della manodopera; tuttavia, i Prodotti non saranno consegnati ovvero offerti a prezzi aumentati senza previa comunicazione.

4.3 Salvo diversa pattuizione, i pagamenti saranno effettuati presso la sede del Venditore, nel rispetto dei termini e delle condizioni concordate; i termini di pagamento decorrono dalla data della fattura.

4.5 In caso di resi parziali concordati, la fornitura dovrà essere comunque pagata per intero. Ricevuto il pagamento da parte dell’Acquirente, il Venditore provvederà ad emettere nota di accredito sul reso ricevuto nel rispetto delle stesse condizioni e termini di pagamento concessi all’Acquirente nel contratto.

ART. 5 - MANCATO O RITARDATO PAGAMENTO

5.1 Per nessuna ragione i pagamenti potranno essere ritardati e/o trattenuti; eventuali reclami o contestazioni non daranno diritto al rifiuto del pagamento ovvero ad eventuali compensazioni.

5.2 Fatti salvi tutti i diritti riconosciuti al Venditore, in caso di ritardo o difetto di pagamento entro i termini convenuti, o di rifiuto di presa in consegna dei Prodotti acquistati e senza pregiudizio all’esercizio dei diritti afferenti alla proprietà:

a) saranno applicati gli interessi di mora, ai sensi del decreto legislativo n. 231/2002, a decorrere dalla data in cui sia maturato il diritto al pagamento;

b) il Venditore potrà sospendere la consegna dei Prodotti così come interrompere la garanzia fino alla sua ripresa, senza pregiudizio sulla relativa data di scadenza nonché imputare le somme fino a quel momento ricevute ai debiti scaduti;

c) l’Acquirente decadrà dal beneficio del termine con diritto per il Venditore di pretendere il pagamento immediato del debito residuo.

ART. 6 - TERMINI DI CONSEGNA

6.1 Se non diversamente concordato per iscritto, qualsiasi termine di consegna indicato non sarà vincolante per il Venditore. Salvo diverso accordo tra le parti, il termine di consegna è indicativo ed è quello precisato nella conferma d’ordine.

6.2 Qualsiasi responsabilità inerente le consegne derivante da forza maggiore o da altri eventi imprevedibili - elencati a titolo esemplificativo, ma non esaustivo, nel successivo art. 12 - non imputabili al Venditore, liberano quest’ultimo dall’obbligo di rispettare il termine di consegna pattuito anche se vincolante.

6.3 Indipendentemente da quanto pattuito in ordine alla resa (porto franco o assegnato) o ai costi di trasporto e di assicurazione, la consegna ed il conseguente trasferimento dei rischi si considereranno intervenuti, in ogni caso ed a tutti gli effetti, con il caricamento della merce sul mezzo di trasporto alla partenza presso lo stabilimento del Venditore.

6.4 Qualora l’acquirente non provveda al ritiro dei Prodotti o ad accettarne la consegna, il Venditore avrà la facoltà, trascorsi 15 giorni dalla diffida ed impregiudicati i rimedi previsti dalla legge, di risolvere il contratto e di rivendere al meglio i Prodotti non ritirati, comunicando all’Acquirente i termini e le condizioni di vendita, trattenendo in via definitiva e a titolo di penale, l’acconto e le eventuali rate di prezzo già versati dal Cliente. La differenza tra il prezzo contrattuale (maggiorato delle spese di custodia e conservazione) e quello ricavato dalla rivendita a terzi costituirà debito del Cliente, su cui maturano gli interessi di mora nella misura indicata all’art. 5.2, lett. a). È fatto comunque salvo il diritto del Venditore al risarcimento del maggior danno eventualmente sofferto.

ART. 7 - RISERVA DI PROPRIETA' E TRASFERIMENTO DEI RISCHI

7.1 Il Venditore conserva la proprietà dei Prodotti fino al completo pagamento degli stessi ivi compresi i costi accessori.

7.2 Intervenuta la consegna, l’Acquirente sarà responsabile per tutti i danni che i Prodotti potranno subire o causare.

7.3 Fino a che non sia intervenuto il completo pagamento, i Prodotti non potranno essere rivenduti senza il previo consenso scritto del Venditore.

ART. 8 - TERMINI DI GARANZIA

8.1 I Prodotti sono fabbricati nel rispetto della normativa applicabile ed il Venditore offre garanzia per un periodo di 24 (ventiquattro) mesi dalla data di consegna.

8.2 Qualsivoglia vizio deve essere denunciato con le modalità previste dal successivo art. 14 entro 8 (otto) giorni dalla data di consegna. In caso di vizi occulti il termine di 8 (otto) giorni inizia a decorrere dal momento della loro scoperta.

8.3 Qualora l’Acquirente sia un “Consumatore”, così come definito nell’art. 3 del Codice del Consumo (decreto legislativo n. 206/2005), la denuncia per l’eventuale difetto di conformità del Prodotto deve essere effettuata entro 2 (due) mesi dalla scoperta.

8.4 Il Venditore non è responsabile per qualsivoglia vizio dei Prodotti derivante da disegni, design o specifiche tecniche fornite dall’Acquirente, così come per i vizi derivanti da usura, inappropriato od inadatto magazzino o modalità d’uso, negligenza o imperizia, manomissione o alterazione dei Prodotti posti in essere dall’Acquirente o da terzi.

8.5 Il Venditore non è responsabile per danni o perdite di qualsiasi genere o natura occorsi alla totalità o parte dei Prodotti durante il trasporto, indipendentemente dal fatto che il trasporto si effettuato da un vettore incaricato da terzi, dall’Acquirente o dallo stesso Venditore, che in tale ultimo caso non assume nessuna garanzia in tal senso liberandosi dall’obbligo della consegna con la semplice rimessa al vettore.

8.6 Nel caso in cui un reclamo per difetti o vizi si riveli ben fondato, la garanzia sarà limitata alla sostituzione o alla riparazione dei Prodotti viziati o dei componenti difettosi con espressa esclusione di qualsivoglia risoluzione contrattuale, riduzione del prezzo, sospensione del pagamento o interruzione della garanzia. La sostituzione dei Prodotti difettosi sarà a discrezione del Venditore previa verifica presso i propri laboratori.

ART. 9 - LIMITAZIONE DELLA RESPONSABILITA'

9.1 Il Venditore non è responsabile per i danni diretti, indiretti e consequenziali senza limitazione alcuna, sofferti da cose o persone durante l’uso e/o la manutenzione dei Prodotti venduti. In tali casi l’Acquirente dovrà mantenere il Venditore esente ed immune da qualsivoglia eventuale domanda, azione, procedura e/o reclamo azionato da terzi danneggiati nei confronti del medesimo.

9.2 L’eventuale responsabilità del Venditore sarà, in ogni caso, limitata al costo dei prodotti difettosi che hanno dato origine a tale responsabilità così come quantificati dal prezzo netto fatturato all’Acquirente.

ART. 10 - DIRITTI DI PROPRIETA' INDUSTRIALE ED INTELLETTUALE

10.1 I marchi, brevetti, disegni, progetti, prototipi, segreti industriali, know-how così come qualsivoglia relativo diritto di proprietà industriale ed intellettuale sono di titolarità esclusiva di LEUCOS e rimangono di proprietà della stessa anche successivamente alla vendita dei Prodotti.

10.2 L’Acquirente per poter esporre i marchi e/o fregi del Venditore nell’ambito della sua attività deve ricevere per iscritto dal medesimo preventiva autorizzazione.

ART. 11 - RISOLUZIONE DEL CONTRATTO

11.1 Nel caso in cui l’Acquirente non effettui il pagamento entro il termine prescritto o si renda inadempiente in modo continuativo o grave senza porvi rimedio entro 30 (trenta) giorni lavorativi decorrenti dalla diffida inviata da LEUCOS, il Venditore potrà immediatamente risolvere il contratto, salvo ed impregiudicato ogni ulteriore diritto.

11.2 In ogni caso, LEUCOS potrà immediatamente risolvere il contratto, nel caso di dichiarazione di fallimento dell’Acquirente, liquidazione, sospensione dei pagamenti o pignoramento, insolvenza ovvero ogni altra situazione che possa incidere sull’adempimento dell’Acquirente.

ART. 12 - FORZA MAGGIORE

12.1 Se l’esecuzione del contratto o di ogni altra obbligazione (diversa dal pagamento) è ostacolata, limitata ovvero impedita da eventi di forza maggiore che persistano per più di 3 (tre) mesi, ciascuna parte potrà risolvere il contratto, senza responsabilità alcuna.

12.2 Per “Evento di forza maggiore” si intende ogni evento al di là del ragionevole controllo della parte interessata, inclusi, senza limitazione alcuna, sciopero, serrata, boicottaggio, guerra, insurrezione, guerra civile, atto vandalico, adeguamento a leggi o disposizioni governative, norme, regolamenti o direttive, incidente, guasto agli impianti o macchinari, incendio, inondazione, difficoltà, ovvero aumento dei costi della manodopera o dei trasporto nonché qualsivoglia altra circostanza in grado di compromettere la fornitura dei Prodotti.

12.3 La parte interessata informerà direttamente l’altra parte del verificarsi dell’evento di forza maggiore di cui abbia avuto conoscenza e che ritenga possa compromettere l’esecuzione del contratto.

ART. 13 - TRATTAMENTO DEI DATI PERSONALI

13.1 dati personali dell’Acquirente saranno trattati secondo quanto disposto dalla legge italiana in materia di trattamento dei dati personali (decreto legislativo n. 196/2003). Il Venditore informa l’Acquirente che il Venditore è il titolare del trattamento e che i dati personali dell’Acquirente vengono raccolti e trattati esclusivamente per l’esecuzione del contratto.

13.2 Per qualsivoglia ulteriore informazione si fa riferimento all’informativa sulla privacy presente nel sito www.leucos.com.

ART. 14 - COMUNICAZIONI

Fatta eccezione per le informazioni di carattere operativo, tutte le comunicazioni saranno trasmesse per iscritto, via fax, lettera raccomandata a/r o P.E.C. o corriere espresso a:
-sede legale- CLANN srl, via del Commercio 22, 36060 Romano d’Ezzelino (VI) ITALY
-sede operativa- LEUCOS a brand of Clann srl, via del Lavoro 22, 30030 Salzano (VE) ITALY
- PEC: clannsrl@legalmail.it

ART. 15 - LEGGE APPLICABILE E FORO COMPETENTE

15.1 Le presenti Condizioni Generali di Vendita LEUCOS, così come ogni relativo contratto di compravendita ed ogni questione che trae origine dagli stessi ovvero connessa, sarà disciplinata, interpretata, eseguita e retta dalla legge ed i regolamenti italiani in vigore, con espressa esclusione della Convenzione di Vienna del 1980 relativa ai contratti di vendita internazionale di beni.

15.2 Qualsiasi controversia insorta tra le parti a seguito dell’interpretazione, validità o esecuzione delle presenti Condizioni Generali di Vendita LEUCOS e dei relativi contratti stipulati sarà devoluta alla competenza esclusiva del Tribunale di Venezia, ogni altro Foro escluso.

15.3 Resta inteso tra le parti che soltanto il Venditore, a propria discrezione, avrà la facoltà di rinunciare alla competenza del Foro esclusivo, di cui al punto 15.2 che precede, per agire in giudizio nei confronti dell’Acquirente, al suo domicilio e presso il Tribunale ivi competente.

ART. 16 - DISPOSIZIONI FINALI

16.1 Diritti e obblighi derivanti dalle presenti Condizioni Generali di Vendita LEUCOS e i relativi contratti di compravendita non potranno essere ceduti senza il previo consenso scritto del Venditore.

16.2 L’invalidità in tutto o in parte di singole disposizioni delle presenti Condizioni Generali di Vendita LEUCOS non inficia la validità delle restanti previsioni.

16.3 I diritti o rimedi di LEUCOS previsti dalle presenti Condizioni Generali di Vendita LEUCOS non pregiudicano qualsivoglia altro diritto o rimedio disposto dalla legge applicabile.

16.4 Il difetto o il ritardo da parte di LEUCOS nell’esercizio dei propri diritti non costituisce rinuncia o perdita di tale diritto.

16.5 La rubricazione degli articoli delle presenti Condizioni Generali LEUCOS in alcun modo potrà essere interpretata quale limitazione ovvero estensione della portata del contenuto della particolare sezione alla quale si riferisce.

16.6 Le presenti Condizioni Generali di Vendita LEUCOS sono redatte in duplice lingua italiana e inglese. In caso sorgessero dubbi interpretativi prevarrà la versione in italiano.

16.7 Le presenti Condizioni Generali di Vendita LEUCOS entrano in vigore dall’1 gennaio 2018 e sostituiscono le precedenti.

16.8 In caso di giustificato motivo, i resi di merce dovranno comunque essere autorizzati per iscritto dall’ufficio commerciale del Venditore, che comunicherà le istruzioni cui attenersi.

Condizioni Generali di Vendita LEUCOS e i relativi contratti di compravendita non potranno essere ceduti senza il previo consenso scritto del Venditore.

16.9 L’invalidità in tutto o in parte di singole disposizioni delle presenti Condizioni Generali di Vendita LEUCOS non inficia la validità delle restanti previsioni.

Ai sensi e per gli effetti di cui agli articoli 1341 e 1342 del Codice Civile, l’Acquirente dichiara di approvare espressamente le seguenti clauseole delle Condizioni Generali di Vendita LEUCOS: 1.3 (aspetti generali); 3 (conclusione del contratto); 6 (termini di consegna); 8.5 – 8.6 (termini di garanzia); 9 (limitazione della responsabilità); 15 (legge applicabile e foro competente); 16 (disposizioni finali).

LEUCOS®

BRIGHT IN ELEGANCE

LEUCOS a brand of Clann srl

Operational headquarters:

Via del Lavoro, 22
30030 Salzano (VE) Italy
tel +39 041 5741111 fax +39 041 5741321
info@leucos.com - www.leucos.com

LEUCOS USA inc.

11 Mayfield Avenue Edison, NJ 08837 - USA
ph +1 (732) 225-0010 fax +1 (732) 225-0250
info@leucosusa.com - www.leucosusa.com

SHOWROOMS

Italy

Via del Commercio 22
36060 Romano d'Ezzelino (VI) Italy

USA

30 Broad St, 27th floor
New York, NY 10004, United States

1550 Biscayne Blvd, Suite 202
Miami, Florida 33132, United States

France *(opening soon)*

68 Rue des Archives
75003, Paris, France

Mexico *(opening soon)*

Av. Insurgentes Sur 1431 Sky Lobby,
Col. Insurgentes Mixcoac
03920 Delegación Benito Juárez CDMX, Mexico



www.leucos.com
www.leucosusa.com



9002981