

BAGA
L O V E L Y L I G H T

hand made in Italy
by

PATRIZIAGARGANTI
F i r e n z e

APRILE 2013

AUMENTO
INCREASE **3%**

Listino prezzi al pubblico 2013 iva esclusa

2013 Gross price list

LOVELYLIGHT

BAGA

LISTINO ANAGRAFICO

ARTICOLO	CATALOGO	PAG. LIST.	PAG. CAT.	PREZZO E	
		RIFERIMENTO	RIFERIMENTO	SOLO BASE	COMPLETO
531	25° ANNIVERSARY	81	173	405,00	745,00
532	25° ANNIVERSARY	87	172	585,00	985,00
533	25° ANNIVERSARY	87	174		798,00
534	25° ANNIVERSARY	87	171		521,00
535	25° ANNIVERSARY	87	170	550,00	915,00
538	25° ANNIVERSARY	87	175		690,00
552	25° ANNIVERSARY	87	165	909,00	1.120,00
553	25° ANNIVERSARY	88	163		1.106,00
560	25° ANNIVERSARY	88	167	1.012,00	1.176,00
561	25° ANNIVERSARY	88	95	682,00	778,00
563	25° ANNIVERSARY	109	197		815,00
567	25° ANNIVERSARY	81	96		149,00
568	25° ANNIVERSARY	81	96		149,00
571	25° ANNIVERSARY	81	96	203,00	268,00
572	25° ANNIVERSARY	81	96	203,00	268,00
592/F	25° ANNIVERSARY	109	231		517,00
592/V	25° ANNIVERSARY	109	231		517,00
593	25° ANNIVERSARY	109	231		517,00
594	25° ANNIVERSARY	109	198		665,00
596	CONTEMPORARY	47			461,00
597	25° ANNIVERSARY	99	103	997,00	1.465,00
598	25° ANNIVERSARY	99	99	997,00	1.465,00
599	25° ANNIVERSARY	99	100	1.111,00	1.735,00
600	25° ANNIVERSARY	93	101	642,00	798,00
601	25° ANNIVERSARY	81	106	250,00	335,00
602	25° ANNIVERSARY	82	106	250,00	335,00
603	25° ANNIVERSARY	82	105		156,00
604	25° ANNIVERSARY	82	105		156,00
605	25° ANNIVERSARY	88	169	1.360,00	1.680,00
606	25° ANNIVERSARY	88	104	781,00	927,00
607	25° ANNIVERSARY	110	235		2.428,00
608	25° ANNIVERSARY	110	236	1.360,00	1.780,00
609	25° ANNIVERSARY	110	236	1.360,00	1.780,00
611	25° ANNIVERSARY	93	237	512,00	592,00
613	25° ANNIVERSARY	93	134		436,00
614	25° ANNIVERSARY	93	134		462,00
615	25° ANNIVERSARY	88	136		890,00
616	25° ANNIVERSARY	110	221		896,00
617	25° ANNIVERSARY	110	219		1.310,00
618	25° ANNIVERSARY	110	219		1.310,00
619	25° ANNIVERSARY	111	192		996,00
620	25° ANNIVERSARY	93	131	482,00	625,00
623	25° ANNIVERSARY	103	122		685,00
624/BI	25° ANNIVERSARY	99	117	1.126,00	1.558,00
625	25° ANNIVERSARY	99	116		1.126,00
626/BI	25° ANNIVERSARY	93	119	476,00	620,00
627	25° ANNIVERSARY	93	118		476,00
628/BI	25° ANNIVERSARY	82	121	298,00	369,00
629/BI	25° ANNIVERSARY	82	121	298,00	369,00
630	25° ANNIVERSARY	82	120		142,00
631	25° ANNIVERSARY	83	121		142,00
634	25° ANNIVERSARY	83	114	555,00	770,00
635	25° ANNIVERSARY	89	115	855,00	1.135,00
637	25° ANNIVERSARY	111	249		805,00
638	25° ANNIVERSARY	111	233		4.870,00
640	25° ANNIVERSARY	94	178	1.165,00	1.285,00
641	25° ANNIVERSARY	94	178	1.165,00	1.285,00
642	25° ANNIVERSARY	94	180	1.165,00	1.285,00
643	25° ANNIVERSARY	94	180	1.165,00	1.285,00
644	25° ANNIVERSARY	94	179	1.165,00	1.285,00
645	25° ANNIVERSARY	94	179	1.165,00	1.285,00
646	25° ANNIVERSARY	94	181	1.165,00	1.285,00
647	25° ANNIVERSARY	94	181	1.165,00	1.285,00
656	25° ANNIVERSARY	94	182	438,00	498,00
657	25° ANNIVERSARY	94	182	438,00	498,00
658	25° ANNIVERSARY	94	183	438,00	498,00
659	25° ANNIVERSARY	94	183	438,00	498,00
661	25° ANNIVERSARY	83	132		530,00
662	25° ANNIVERSARY	95	111	168,00	264,00
663	25° ANNIVERSARY	95	110	268,00	460,00
666	25° ANNIVERSARY	99	109	859,00	1.435,00
668	25° ANNIVERSARY	83	107	191,00	263,00
668/BI	25° ANNIVERSARY	83	120	191,00	263,00
669	25° ANNIVERSARY	83	107	191,00	263,00
669/BI	25° ANNIVERSARY	39	69	191,00	263,00
670	25° ANNIVERSARY	111	224		878,00
671	25° ANNIVERSARY	111	228		2.980,00
673	25° ANNIVERSARY	111	229		3.120,00
674	25° ANNIVERSARY	112	222		2.160,00
675	25° ANNIVERSARY	112	226		2.210,00
676	25° ANNIVERSARY	112	230		524,00
677	25° ANNIVERSARY	112	230		624,00
678	25° ANNIVERSARY	89	127		475,00
679	25° ANNIVERSARY	89	127		475,00
680	25° ANNIVERSARY	83	124		265,00
681	25° ANNIVERSARY	84	125		286,00
683	CONTEMPORARY	29	261	1.117,00	1.325,00
684	25° ANNIVERSARY	89	123	670,00	950,00

ARTICOLO	CATALOGO	PAG. LIST.	PAG. CAT.	PREZZO E	
		RIFERIMENTO	RIFERIMENTO	SOLO BASE	COMPLETO
685	CONTEMPORARY	29	262	1.198,00	1.454,00
685/PN	PROGRESS	10	139	1.198,00	1.390,00
686	CONTEMPORARY	29	263	1.219,00	1.475,00
686/PA	PROGRESS	10	138	1.219,00	1.411,00
688	XXI CENTURY	49	92	240,00	364,00
689	XXI CENTURY	49	92	240,00	364,00
690	XXI CENTURY	49	90	314,00	468,00
691	XXI CENTURY	49	90	314,00	468,00
692	XXI CENTURY	49	93		175,00
693	XXI CENTURY	49	93		175,00
700	25° ANNIVERSARY	112	188		2.355,00
700/A	25° ANNIVERSARY	112	189	144,00	248,00
702	25° ANNIVERSARY	113	190		2.900,00
702/C	25° ANNIVERSARY	113	190		409,00
705	25° ANNIVERSARY	113	195		948,00
706	25° ANNIVERSARY	113	223		2.360,00
709	25° ANNIVERSARY	111	225		878,00
712	25° ANNIVERSARY	89	161	750,00	925,00
713	25° ANNIVERSARY	113	201		625,00
714	25° ANNIVERSARY	89	161		825,00
715	25° ANNIVERSARY	95	156	545,00	695,00
716	25° ANNIVERSARY	95	157	545,00	695,00
718	25° ANNIVERSARY	90	44	585,00	879,00
719	25° ANNIVERSARY	99	40	553,00	835,00
720	25° ANNIVERSARY	99	41	741,00	1.305,00
721	25° ANNIVERSARY	100	39	995,00	1.841,00
722	25° ANNIVERSARY	103	56		542,00
723	25° ANNIVERSARY	95	50	184,00	278,00
724	25° ANNIVERSARY	95	49	295,00	483,00
725	25° ANNIVERSARY	96	48	310,00	498,00
726	25° ANNIVERSARY	84	47	189,00	264,00
727	25° ANNIVERSARY	84	47	189,00	264,00
728	25° ANNIVERSARY	84	57		138,00
729	25° ANNIVERSARY	84	57		138,00
730	25° ANNIVERSARY	84	54	360,00	548,00
731	25° ANNIVERSARY	85	55	448,00	730,00
732	25° ANNIVERSARY	85	152		515,00
733	25° ANNIVERSARY	85	155		265,00
734	25° ANNIVERSARY	90	152		741,00
735	25° ANNIVERSARY	96	154		469,00
736	25° ANNIVERSARY	90	150		964,00
737	25° ANNIVERSARY	85	142	460,00	555,00
738	25° ANNIVERSARY	90	140	860,00	1.060,00
739	25° ANNIVERSARY	85	144	375,00	498,00
740	25° ANNIVERSARY	90	144	665,00	865,00
741	25° ANNIVERSARY	96	146	430,00	525,00
742	25° ANNIVERSARY	100	149	1.168,00	1.696,00
743	25° ANNIVERSARY	113	202		1.660,00
744	25° ANNIVERSARY	95	53	295,00	445,00
745	25° ANNIVERSARY	95	51	184,00	259,00
746	25° ANNIVERSARY	85	52	448,00	673,00
747	25° ANNIVERSARY	84	52	360,00	510,00
748	25° ANNIVERSARY	96	46	310,00	460,00
749	25° ANNIVERSARY	90	45	585,00	810,00
750	25° ANNIVERSARY	99	42	553,00	778,00
751	25° ANNIVERSARY	99	42	741,00	1.191,00
752	25° ANNIVERSARY	100	42	995,00	1.670,00
754	25° ANNIVERSARY	114	245		SU RICHIESTA
755	25° ANNIVERSARY	100	5	1.085,00	1.285,00
756	25° ANNIVERSARY	100	7	1.216,00	1.516,00
757	25° ANNIVERSARY	103	10		628,00
758	25° ANNIVERSARY	103	10		814,00
759	25° ANNIVERSARY	90	9		685,00
760	25° ANNIVERSARY	91	8	675,00	755,00
761	25° ANNIVERSARY	85	11	268,00	318,00
762	25° ANNIVERSARY	96	6	560,00	660,00
763	25° ANNIVERSARY	114	187		3.965,00
764	25° ANNIVERSARY	114	242		SU RICHIESTA
765	25° ANNIVERSARY	114	241		1.245,00
766	25° ANNIVERSARY	91	16	766,00	960,00
767	25° ANNIVERSARY	86	17	501,00	598,00
768	25° ANNIVERSARY	96	14	462,00	556,00
769	25° ANNIVERSARY	96	15	351,00	445,00
770	XXI CENTURY	73	341		3.965,00
780	25° ANNIVERSARY	86	66	1.164,00	1.604,00
782	XXI CENTURY	50	40	1.194,00	1.842,00
784	25° ANNIVERSARY	97	64	544,00	654,00
786	25° ANNIVERSARY	86	70	1.194,00	1.634,00
787	25° ANNIVERSARY	97	71	544,00	654,00
788	25° ANNIVERSARY	97	71	645,00	810,00
792	25° ANNIVERSARY	97	65	645,00	810,00
796	25° ANNIVERSARY	91	82	865,00	1.170,00
797	25° ANNIVERSARY	97	90		315,00
798	25° ANNIVERSARY	97	91		215,00
799	25° ANNIVERSARY	86	59	547,00	680,00
800	25° ANNIVERSARY	86	72	547,00	680,00
801	25° ANNIVERSARY	91	59	705,00	838,00
802	25° ANNIVERSARY	91	72	705,00	838,00

ARTICOLO	CATALOGO	PAG. LIST.	PAG. CAT.	PREZZO E	
		RIFERIMENTO	RIFERIMENTO	SOLO BASE	COMPLETO
803	25° ANNIVERSARY	86	20	438,00	694,00
804	25° ANNIVERSARY	86	21	438,00	694,00
805	25° ANNIVERSARY	86	20	453,00	709,00
806	25° ANNIVERSARY	86	21	453,00	709,00
807	25° ANNIVERSARY	91	22	975,00	1.370,00
808	25° ANNIVERSARY	91	23	975,00	1.370,00
809	25° ANNIVERSARY	97	24	510,00	786,00
810	25° ANNIVERSARY	97	24	510,00	786,00
811	25° ANNIVERSARY	86	20	364,00	580,00
812	25° ANNIVERSARY	86	21	364,00	580,00
813	25° ANNIVERSARY	100	33	706,00	1.120,00
814	25° ANNIVERSARY	100	33	706,00	1.120,00
815	25° ANNIVERSARY	100	32	1.237,00	2.065,00
816	25° ANNIVERSARY	100	32	1.237,00	2.065,00
817	25° ANNIVERSARY	101	69	2.273,00	2.885,00
818	25° ANNIVERSARY	101	35	2.273,00	3.857,00
819	25° ANNIVERSARY	101	35	2.273,00	3.857,00
820	25° ANNIVERSARY	101	60	2.273,00	2.885,00
822	25° ANNIVERSARY	91	29		1.395,00
823	25° ANNIVERSARY	91	29		1.395,00
824	25° ANNIVERSARY	101	68	1.152,00	1.560,00
825	25° ANNIVERSARY	101	62	1.152,00	1.560,00
827	25° ANNIVERSARY	97	74	337,00	405,00
828	25° ANNIVERSARY	97	74	337,00	405,00
829	25° ANNIVERSARY	98	75	337,00	405,00
830	25° ANNIVERSARY	98	75	337,00	405,00
831	25° ANNIVERSARY	98	27	337,00	513,00
832	25° ANNIVERSARY	98	27	337,00	513,00
834	25° ANNIVERSARY	97	26	337,00	513,00
835	25° ANNIVERSARY	97	26	337,00	513,00
837	25° ANNIVERSARY	101	79	836,00	996,00
838	25° ANNIVERSARY	92	76	685,00	825,00
841	25° ANNIVERSARY	101	85	1.370,00	1.735,00
842	25° ANNIVERSARY	101	86	1.370,00	1.735,00
843	25° ANNIVERSARY	103	88		698,00
844	25° ANNIVERSARY	103	89		698,00
845	25° ANNIVERSARY	103	31		370,00
846	25° ANNIVERSARY	103	30		370,00
847	XXI CENTURY	50	298	214,00	268,00
848	XXI CENTURY	50	298	214,00	268,00
849	XXI CENTURY	50	301	214,00	268,00
850	XXI CENTURY	50	301	214,00	268,00
851	XXI CENTURY	50	296	214,00	268,00
852	XXI CENTURY	50	297	214,00	268,00
853	XXI CENTURY	50	300	214,00	268,00
854	XXI CENTURY	50	300	214,00	268,00
855	25° ANNIVERSARY	114	217		1.890,00
856	25° ANNIVERSARY	114	207		1.270,00
857	25° ANNIVERSARY	115	209		1.955,00
858	25° ANNIVERSARY	115	215		3.470,00
859	25° ANNIVERSARY	115	215		3.470,00
860	25° ANNIVERSARY	115	215		2.770,00
861	25° ANNIVERSARY	115	205		2.772,00
862	25° ANNIVERSARY	115	204		2.772,00
863	25° ANNIVERSARY	115	204		1.872,00
864	25° ANNIVERSARY	115	210		3.490,00
865	25° ANNIVERSARY	115	210		3.490,00
866	25° ANNIVERSARY	115	210		2.790,00
867	25° ANNIVERSARY	115	247		SU RICHIESTA
872	25° ANNIVERSARY	115	216		SU RICHIESTA
873	25° ANNIVERSARY	115	216		SU RICHIESTA
874	25° ANNIVERSARY	102	61	1.412,00	1.820,00
875	25° ANNIVERSARY	102	69	1.412,00	1.820,00
876	25° ANNIVERSARY	102	34	1.412,00	2.240,00
877	25° ANNIVERSARY	102	34	1.412,00	2.240,00
879	XXI CENTURY	50	312	808,00	1.195,00
880	XXI CENTURY	50	314	737,00	975,00
881	XXI CENTURY	50	315	770,00	1.130,00
882	XXI CENTURY	56	285		835,00
883	XXI CENTURY	56	286		835,00
884	XXI CENTURY	59	284		468,00
885	XXI CENTURY	59	287		468,00
886	XXI CENTURY	59	324	396,00	615,00
887	XXI CENTURY	59	330	396,00	738,00
888	XXI CENTURY	59	326	374,00	520,00
889	XXI CENTURY	59	326	374,00	602,00
890	XXI CENTURY	64	323	1.552,00	1.990,00
891	XXI CENTURY	64	328	1.552,00	2.236,00
892	XXI CENTURY	50	325	294,00	420,00
893	XXI CENTURY	50	331	294,00	420,00
894	XXI CENTURY	50	325	294,00	420,00
895	XXI CENTURY	50	331	294,00	420,00
896	XXI CENTURY	51	325	332,00	480,00
897	XXI CENTURY	51	331	332,00	480,00
898	XXI CENTURY	59	304		488,00
899	XXI CENTURY	59	304		488,00
900	XXI CENTURY	59	305		488,00
901	XXI CENTURY	51	303		273,00

ARTICOLO	CATALOGO	PAG. LIST.	PAG. CAT.	PREZZO E	
		RIFERIMENTO	RIFERIMENTO	SOLO BASE	COMPLETO
902	XXI CENTURY	51	302		273,00
903	XXI CENTURY	51	302		273,00
904	XXI CENTURY	51	291		390,00
905	XXI CENTURY	51	290		390,00
906	XXI CENTURY	51	292		345,00
907	XXI CENTURY	51	292		345,00
908	XXI CENTURY	51	320	293,00	385,00
909	XXI CENTURY	51	321	293,00	409,00
910	XXI CENTURY	51	316	313,00	505,00
911	XXI CENTURY	51	318	304,00	396,00
912	XXI CENTURY	51	310		384,00
913	XXI CENTURY	59	332		466,00
914	XXI CENTURY	59	332		522,00
915	XXI CENTURY	60	334	598,00	681,00
917	XXI CENTURY	52	333		590,00
918	XXI CENTURY	56	307	586,00	690,00
919	XXI CENTURY	56	308	512,00	566,00
920	XXI CENTURY	56	280	934,00	1.060,00
921	XXI CENTURY	52	281	565,00	628,00
922	XXI CENTURY	60	282	555,00	618,00
923	XXI CENTURY	60	283	348,00	446,00
924	XXI CENTURY	56	272		948,00
930	XXI CENTURY	64	220	703,00	916,00
931	XXI CENTURY	60	221	423,00	565,00
932	XXI CENTURY	52	222	388,00	478,00
933	XXI CENTURY	56	218	669,00	808,00
940	XXI CENTURY	64	190	726,00	948,00
941	XXI CENTURY	60	191	437,00	585,00
942	XXI CENTURY	52	192	388,00	478,00
950	XXI CENTURY	64	196	748,00	931,00
951	XXI CENTURY	60	201	462,00	584,00
952	XXI CENTURY	52	199	388,00	478,00
960	XXI CENTURY	64	240	1.600,00	2.016,00
961	XXI CENTURY	60	245	502,00	658,00
962	XXI CENTURY	60	245	346,00	398,00
970	XXI CENTURY	64	249	1.600,00	2.016,00
971	XXI CENTURY	60	253	464,00	620,00
972	XXI CENTURY	60	253	323,00	375,00
980	XXI CENTURY	64	167	1.498,00	2.074,00
980/M	XXI CENTURY	64	172	1.498,00	2.074,00
981	XXI CENTURY	61	179	382,00	598,00
981/M	XXI CENTURY	61	179	382,00	598,00
982	XXI CENTURY	61	176	334,00	406,00
982/M	XXI CENTURY	61	176	334,00	406,00
983	XXI CENTURY	52	181	388,00	478,00
983/M	XXI CENTURY	52	180	388,00	478,00
984	XXI CENTURY	64	164	1.132,00	1.420,00
984/M	XXI CENTURY	64	164	1.132,00	1.420,00
985	XXI CENTURY	56	168	669,00	808,00
985/M	XXI CENTURY	56	169	669,00	808,00
986	XXI CENTURY	61	174	200,00	272,00
986/M	XXI CENTURY	61	174	200,00	272,00
990	XXI CENTURY	64	158	1.498,00	2.074,00
991	XXI CENTURY	61	154	330,00	402,00
992	XXI CENTURY	61	154	372,00	588,00
993	XXI CENTURY	61	159	200,00	272,00
994	XXI CENTURY	64	152	1.132,00	1.420,00
995	XXI CENTURY	56	157	669,00	808,00
1000	XXI CENTURY	61	184	356,00	408,00
1000/M	XXI CENTURY	61	184	356,00	408,00
1001	XXI CENTURY	62	185		172,00
1002	XXI CENTURY	61	243	356,00	408,00
1003	XXI CENTURY	62	242		172,00
1004	XXI CENTURY	61	160	356,00	408,00
1005	XXI CENTURY	62	163		172,00
1006	XXI CENTURY	61	202	356,00	408,00
1007	XXI CENTURY	62	203		172,00
1008	XXI CENTURY	61	206	406,00	458,00
1008/BI	XXI CENTURY	61	211	406,00	458,00
1009	XXI CENTURY	62	213		172,00
1010	XXI CENTURY	52	183	348,00	460,00
1010/M	XXI CENTURY	52	182	348,00	460,00
1011	XXI CENTURY	52	246	348,00	460,00
1012	XXI CENTURY	52	247	348,00	460,00
1013	XXI CENTURY	52	162	348,00	460,00
1014	XXI CENTURY	53	210	446,00	589,00
1015	XXI CENTURY	53	207	507,00	688,00
1016	XXI CENTURY	53	274	556,00	834,00
1017	XXI CENTURY	53	275	556,00	834,00
1018	XXI CENTURY	53	193	293,00	348,00
1019	XXI CENTURY	53	223	287,00	343,00
1020	XXI CENTURY	53	186	333,00	404,00
1020/M	XXI CENTURY	53	187	333,00	404,00
1021	XXI CENTURY	53	200	310,00	372,00
1022	XXI CENTURY	53	257	348,00	448,00
1022/AV	XXI CENTURY	53	256	348,00	448,00
1023	XXI CENTURY	53	256	348,00	448,00
1023/BI	XXI CENTURY	53	256	348,00	448,00

LOVELYLIGHT

BAGA

LISTINO ANAGRAFICO

ARTICOLO	CATALOGO	PAG. LIST.	PAG. CAT.	PREZZO E	
		RIFERIMENTO	RIFERIMENTO	SOLO BASE	COMPLETO
1025	XXI CENTURY	56	279		530,00
1026	XXI CENTURY	57	278		530,00
1027	XXI CENTURY	53	276	255,00	378,00
1028	XXI CENTURY	54	276	259,00	382,00
1029	XXI CENTURY	62	337	334,00	438,00
1030	XXI CENTURY	57	258	1.084,00	1.248,00
1030/AV	XXI CENTURY	57	258	1.084,00	1.248,00
1031	XXI CENTURY	54	263	476,00	588,00
1031/AV	XXI CENTURY	54	262	476,00	588,00
1032	XXI CENTURY	54	263	503,00	615,00
1032/AV	XXI CENTURY	54	262	503,00	615,00
1033	XXI CENTURY	54	263	409,00	508,00
1033/AV	XXI CENTURY	54	262	409,00	508,00
1034	XXI CENTURY	62	264	638,00	760,00
1034/AV	XXI CENTURY	62	264	638,00	760,00
1035	XXI CENTURY	64	266	897,00	1.080,00
1035/AV	XXI CENTURY	64	267	897,00	1.080,00
1037	XXI CENTURY	57	270		1.580,00
1037/AV	XXI CENTURY	57	271		1.580,00
1038	XXI CENTURY	65	261	2.441,00	3.206,00
1038/AV	XXI CENTURY	65	260	2.441,00	3.206,00
1039	XXI CENTURY	65	268	1.474,00	1.840,00
1039/AV	XXI CENTURY	65	269	1.474,00	1.840,00
1041	CONTEMPORARY	21	229	476,00	737,00
1042	CONTEMPORARY	21	229	503,00	764,00
1044	CONTEMPORARY	33	297	613,00	945,00
1045	CONTEMPORARY	39	9	828,00	1.326,00
1046	CONTEMPORARY	29	255	1.085,00	1.430,00
1050	XXI CENTURY	73	366		880,00
1051	XXI CENTURY	73	364		1.948,00
1052	XXI CENTURY	57	204	887,00	1.192,00
1052/AV	XXI CENTURY	57	205	887,00	1.192,00
1053	CONTEMPORARY	47			2.672,00
1054	XXI CENTURY	73	369		SU RICHIESTA
1056	CONTEMPORARY	47			SU RICHIESTA
1058	XXI CENTURY	73	370		1.078,00
1060	XXI CENTURY	57	16		438,00
1061	XXI CENTURY	57	16		438,00
1062	XXI CENTURY	65	19		878,00
1063	XXI CENTURY	65	18		878,00
1064	XXI CENTURY	54	21		905,00
1065	XXI CENTURY	54	20		905,00
1066	XXI CENTURY	65	251	998,00	1.264,00
1067	XXI CENTURY	65	219	998,00	1.264,00
1068	XXI CENTURY	65	227	998,00	1.264,00
1069	XXI CENTURY	65	234	795,00	990,00
1070	XXI CENTURY	65	232	795,00	990,00
1071	XXI CENTURY	65	170	795,00	990,00
1072	XXI CENTURY	54	236	778,00	1.148,00
1073	XXI CENTURY	54	226	778,00	1.148,00
1074	XXI CENTURY	54	215	778,00	1.148,00
1075	XXI CENTURY	54	230	778,00	1.148,00
1076	XXI CENTURY	65	216	1.058,00	1.484,00
1077	XXI CENTURY	66	228	1.157,00	1.745,00
1078	XXI CENTURY	66	238	1.157,00	1.745,00
1079	XXI CENTURY	65	195	1.092,00	1.458,00
1080	XXI CENTURY	66	146	3.862,00	5.566,00
1081	XXI CENTURY	66	140	3.862,00	5.566,00
1082	XXI CENTURY	62	150	1.976,00	2.624,00
1083	XXI CENTURY	62	143	1.976,00	2.624,00
1084	XXI CENTURY	58	148	1.442,00	1.822,00
1085	XXI CENTURY	58	142	1.442,00	1.822,00
1086	XXI CENTURY	55	149	1.004,00	1.364,00
1087	XXI CENTURY	55	138	1.004,00	1.364,00
1090	XXI CENTURY	66	37	1.532,00	2.396,00
1091	XXI CENTURY	62	43	646,00	1.078,00
1092	XXI CENTURY	63	42	196,00	268,00
1100	XXI CENTURY	66	74	1.472,00	2.504,00
1101	XXI CENTURY	62	77	646,00	1.162,00
1102	XXI CENTURY	63	76	196,00	268,00
1110	XXI CENTURY	66	47	1.472,00	2.336,00
1111	XXI CENTURY	63	49	196,00	268,00
1112	XXI CENTURY	62	48	646,00	1.078,00
1120	XXI CENTURY	66	88	1.750,00	2.494,00
1121	XXI CENTURY	63	91	196,00	320,00
1130	XXI CENTURY	66	97	1.813,00	2.245,00
1131	XXI CENTURY	63	94	196,00	268,00
1140	XXI CENTURY	66	63	1.813,00	2.368,00
1141	XXI CENTURY	63	67	196,00	288,00
1150	XXI CENTURY	66	28		2.086,00
1151	XXI CENTURY	63	31		408,00
1152	XXI CENTURY	66	30		342,00
1153	XXI CENTURY	55	31		474,00
1154	XXI CENTURY	58	31		716,00
1160	XXI CENTURY	66	22		2.086,00
1161	XXI CENTURY	63	27		408,00
1162	XXI CENTURY	66	25		342,00
1163	XXI CENTURY	55	24		474,00

ARTICOLO	CATALOGO	PAG. LIST.	PAG. CAT.	PREZZO E	
		RIFERIMENTO	RIFERIMENTO	SOLO BASE	COMPLETO
1164	XXI CENTURY	58	24		716,00
1170	XXI CENTURY	66	34		2.086,00
1171	XXI CENTURY	63	33		408,00
1172	XXI CENTURY	66	33		342,00
1173	XXI CENTURY	55	34		474,00
1174	XXI CENTURY	58	35		716,00
1180	XXI CENTURY	67	86	4.978,00	7.138,00
1181	XXI CENTURY	67	52	4.978,00	7.138,00
1182	CONTEMPORARY	39	107	3.742,00	5.182,00
1183	CONTEMPORARY	33	280	672,00	990,00
1184	CONTEMPORARY	39	106	3.742,00	5.182,00
1185	CONTEMPORARY	33	281	672,00	990,00
1186	CONTEMPORARY	39	7	3.742,00	5.182,00
1187	CONTEMPORARY	33	279	672,00	990,00
1188	CONTEMPORARY	39	5	4.762,00	6.062,00
1189	CONTEMPORARY	33	277	1.305,00	1.695,00
1190	XXI CENTURY	68	229		528,00
1191	XXI CENTURY	68	239		528,00
1192	XXI CENTURY	68	194		698,00
1193	XXI CENTURY	68			698,00
1194	XXI CENTURY	68	171		890,00
1195	XXI CENTURY	68	235		890,00
1196	XXI CENTURY	68	233		890,00
1197	XXI CENTURY	63	171	542,00	738,00
1198	XXI CENTURY	63	235	542,00	738,00
1199	XXI CENTURY	63	233	542,00	738,00
2000	XXI CENTURY	73	352		934,00
2001	XXI CENTURY	73	353		959,00
2002	XXI CENTURY	73	352		996,00
2003	XXI CENTURY	74	355		1.020,00
2004	XXI CENTURY	74	355		1.060,00
2005	XXI CENTURY	74	354		1.090,00
2006	XXI CENTURY	74	342		635,00
2007	XXI CENTURY	74	343		635,00
2008	XXI CENTURY	74	342		635,00
2009	XXI CENTURY	74	357		1.388,00
2010	XXI CENTURY	74	357		1.388,00
2011	XXI CENTURY	74	356		1.388,00
2012	XXI CENTURY	74	362		1.980,00
2013	XXI CENTURY	74	362		1.980,00
2014	XXI CENTURY	74	363		1.980,00
2015	XXI CENTURY	74	347		1.580,00
2016	XXI CENTURY	74	344		1.030,00
2017	XXI CENTURY	75	359		2.285,00
2018	XXI CENTURY	75	358		2.318,00
2019	XXI CENTURY	75	359		2.460,00
2020	XXI CENTURY	75	351		860,00
2021	XXI CENTURY	75	351		883,00
2022	XXI CENTURY	75	350		936,00
2023	XXI CENTURY	75			3.460,00
2024	XXI CENTURY	75			3.520,00
2025	XXI CENTURY	75			3.680,00
2030	CONTEMPORARY	47			SU RICHIESTA
2031	CONTEMPORARY	47			SU RICHIESTA
2034	CONTEMPORARY	47			SU RICHIESTA
2035	CONTEMPORARY	47			SU RICHIESTA
2036	CONTEMPORARY	47			SU RICHIESTA
2037	CONTEMPORARY	47			SU RICHIESTA
2050	CONTEMPORARY	39	93	1.038,00	1.518,00
2051	CONTEMPORARY	33	316	338,00	418,00
2052	CONTEMPORARY	33	314	338,00	418,00
2053	CONTEMPORARY	33	316	624,00	840,00
2054	CONTEMPORARY	34	314	554,00	698,00
2055	CONTEMPORARY	29	235	691,00	824,00
2056	CONTEMPORARY	21	231	582,00	715,00
2057	CONTEMPORARY	34	299	635,00	891,00
2058	CONTEMPORARY	21	225	166,00	498,00
2059	CONTEMPORARY	21	225	166,00	398,00
2060	CONTEMPORARY	39	32		4.380,00
2061	CONTEMPORARY	21		166,00	328,00
2062	CONTEMPORARY	22		166,00	328,00
2063	CONTEMPORARY	22		166,00	328,00
2064	CONTEMPORARY	22		166,00	328,00
2065	CONTEMPORARY	22	183	166,00	245,00
2066	CONTEMPORARY	22	183	166,00	245,00
2067	CONTEMPORARY	22	183	166,00	245,00
2068	CONTEMPORARY	23	183	166,00	245,00
2070	CONTEMPORARY	39	33		4.380,00
2071	CONTEMPORARY	21		166,00	328,00
2072	CONTEMPORARY	22		166,00	328,00
2073	CONTEMPORARY	22		166,00	328,00
2074	CONTEMPORARY	22		166,00	328,00
2075	CONTEMPORARY	23	187	166,00	245,00
2076	CONTEMPORARY	23	187	166,00	245,00
2077	CONTEMPORARY	23	187	166,00	245,00
2078	CONTEMPORARY	23	187	166,00	245,00
2080	CONTEMPORARY	39	35		4.380,00
2081	CONTEMPORARY	21	189	166,00	328,00

ARTICOLO	CATALOGO	PAG. LIST.	PAG. CAT.	PREZZO E	
		RIFERIMENTO	RIFERIMENTO	SOLO BASE	COMPLETO
2082	CONTEMPORARY	22	189	166,00	328,00
2083	CONTEMPORARY	22	189	166,00	328,00
2084	CONTEMPORARY	22	189	166,00	328,00
2090	CONTEMPORARY	39	95	1.750,00	2.362,00
2091	CONTEMPORARY	34	98	200,00	302,00
2100	CONTEMPORARY	27			742,00
2101	CONTEMPORARY	27			742,00
2102	CONTEMPORARY	27	153		742,00
2104	CONTEMPORARY	40	149		834,00
2105	CONTEMPORARY	40	148		834,00
2106	CONTEMPORARY	40	151		834,00
2108	CONTEMPORARY	28			734,00
2109	CONTEMPORARY	28			734,00
2110	CONTEMPORARY	28	155		754,00
2112	CONTEMPORARY	28			1.172,00
2113	CONTEMPORARY	28	159		1.172,00
2114	CONTEMPORARY	28	161		1.192,00
2116	CONTEMPORARY	28	175	890,00	1.380,00
2117	CONTEMPORARY	28	174	890,00	1.200,00
2118	CONTEMPORARY	28	177	890,00	1.470,00
2125	CONTEMPORARY	25	179	890,00	1.356,00
2140	CONTEMPORARY	34	303	191,00	270,00
2141	CONTEMPORARY	35	305		348,00
2142	CONTEMPORARY	34	310	191,00	316,00
2143	CONTEMPORARY	35	308	191,00	350,00
2143/V	CONTEMPORARY	35	310	191,00	350,00
2144	CONTEMPORARY	40	139		198,00
2145	CONTEMPORARY	40	137		232,00
2145/V	CONTEMPORARY	40	136		232,00
2146	CONTEMPORARY	25	207	301,00	380,00
2147	CONTEMPORARY	25	209	343,00	422,00
2148	CONTEMPORARY	25	208	320,00	399,00
2150	CONTEMPORARY	46	39		3.116,00
2151	CONTEMPORARY	46			3.116,00
2152	CONTEMPORARY	46	41		3.156,00
2153	CONTEMPORARY	46			2.868,00
2154	CONTEMPORARY	46			2.868,00
2155	CONTEMPORARY	46			2.868,00
2160	CONTEMPORARY	46			4.140,00
2161	CONTEMPORARY	46	71		4.140,00
2162	CONTEMPORARY	46	73		4.140,00
2163	CONTEMPORARY	46			3.739,00
2164	CONTEMPORARY	46			3.739,00
2165	CONTEMPORARY	46			3.739,00
2170	CONTEMPORARY	46			7.364,00
2171	CONTEMPORARY	46	66		7.364,00
2172	CONTEMPORARY	46			7.364,00
2173	CONTEMPORARY	46			7.046,00
2174	CONTEMPORARY	46			7.046,00
2175	CONTEMPORARY	46			7.046,00
2178	COLLECTIONS BOOK	14	23		14.874,00
2180	CONTEMPORARY	44	74		2.688,00
2181	CONTEMPORARY	44			2.688,00
2182	CONTEMPORARY	44	77		2.688,00
2183	CONTEMPORARY	44	75		2.696,00
2184	CONTEMPORARY	44			2.696,00
2185	CONTEMPORARY	44			2.696,00
2190	CONTEMPORARY	40	83	2.508,00	2.756,00
2191	CONTEMPORARY	40	81	2.508,00	2.748,00
2192	CONTEMPORARY	40		2.508,00	2.748,00
2193	CONTEMPORARY	40		2.326,00	2.574,00
2194	CONTEMPORARY	40	80	2.326,00	2.574,00
2195	CONTEMPORARY	40		2.326,00	2.574,00
2200	CONTEMPORARY	25	173	1.382,00	1.698,00
2201	CONTEMPORARY	25		1.382,00	1.698,00
2202	CONTEMPORARY	25	171	1.382,00	1.698,00
2203	CONTEMPORARY	25		1.262,00	1.578,00
2204	CONTEMPORARY	25	170	1.262,00	1.578,00
2205	CONTEMPORARY	25		1.262,00	1.578,00
2210	CONTEMPORARY	35	295	278,00	356,00
2211	CONTEMPORARY	35		278,00	325,00
2212	CONTEMPORARY	35	294	278,00	325,00
2213	CONTEMPORARY	35		261,00	340,00
2214	CONTEMPORARY	35		261,00	325,00
2215	CONTEMPORARY	35		261,00	340,00
2220	CONTEMPORARY	35		379,00	458,00
2221	CONTEMPORARY	35	293	379,00	426,00
2222	CONTEMPORARY	35		379,00	426,00
2223	CONTEMPORARY	35		356,00	435,00
2224	CONTEMPORARY	35		356,00	403,00
2225	CONTEMPORARY	35	292	356,00	435,00
2230	CONTEMPORARY	36	289	436,00	594,00
2231	CONTEMPORARY	36		436,00	530,00
2232	CONTEMPORARY	36		436,00	530,00
2233	CONTEMPORARY	36	288	426,00	584,00
2234	CONTEMPORARY	36		426,00	520,00
2235	CONTEMPORARY	36		426,00	584,00
2240	CONTEMPORARY	36	290	578,00	815,00

ARTICOLO	CATALOGO	PAG. LIST.	PAG. CAT.	PREZZO E	
		RIFERIMENTO	RIFERIMENTO	SOLO BASE	COMPLETO
2241	CONTEMPORARY	36		578,00	719,00
2242	CONTEMPORARY	36		578,00	719,00
2243	CONTEMPORARY	36		566,00	803,00
2244	CONTEMPORARY	36	291	566,00	707,00
2245	CONTEMPORARY	36		566,00	803,00
2250	CONTEMPORARY	41	48	2.462,00	2.936,00
2251	CONTEMPORARY	41		2.462,00	2.810,00
2252	CONTEMPORARY	41	49	2.462,00	2.810,00
2253	CONTEMPORARY	41		2.074,00	2.548,00
2254	CONTEMPORARY	41	51	2.074,00	2.422,00
2255	CONTEMPORARY	41		2.074,00	2.548,00
2260	CONTEMPORARY	41	59	1.362,00	1.599,00
2261	CONTEMPORARY	41		1.362,00	1.536,00
2262	CONTEMPORARY	41	57	1.362,00	1.536,00
2263	CONTEMPORARY	41	55	1.218,00	1.455,00
2264	CONTEMPORARY	41	56	1.218,00	1.392,00
2265	CONTEMPORARY	41		1.218,00	1.455,00
2270	CONTEMPORARY	42			1.310,00
2271	CONTEMPORARY	42			1.310,00
2272	CONTEMPORARY	42			1.310,00
2273	CONTEMPORARY	42			1.179,00
2274	CONTEMPORARY	42	61		1.179,00
2275	CONTEMPORARY	42	63		1.179,00
2282	CONTEMPORARY	42	89		3.712,00
2284	CONTEMPORARY	42	87		3.668,00
2292	CONTEMPORARY	26	167		643,00
2294	CONTEMPORARY	26	165		643,00
2302	CONTEMPORARY	26	167		643,00
2304	CONTEMPORARY	26	165		643,00
2312	CONTEMPORARY	29	239		1.290,00
2314	CONTEMPORARY	29	241		1.215,00
2316	CONTEMPORARY	30		595,00	723,00
2317	CONTEMPORARY	30	243	520,00	648,00
2318	CONTEMPORARY	30		520,00	648,00
2322	CONTEMPORARY	30	239		1.290,00
2324	CONTEMPORARY	30	241		1.215,00
2326	CONTEMPORARY	30		595,00	723,00
2327	CONTEMPORARY	30	243	520,00	648,00
2328	CONTEMPORARY	30		520,00	648,00
2336	CONTEMPORARY	30		595,00	723,00
2337	CONTEMPORARY	30	245	520,00	648,00
2338	CONTEMPORARY	30		520,00	648,00
2346	CONTEMPORARY	30		595,00	723,00
2347	CONTEMPORARY	30	245	520,00	648,00
2348	CONTEMPORARY	30		520,00	648,00
2350	CONTEMPORARY	42		4.380,00	5.328,00
2351	CONTEMPORARY	42		4.380,00	5.076,00
2352	CONTEMPORARY	42		4.380,00	5.076,00
2353	CONTEMPORARY	42		4.178,00	5.126,00
2354	CONTEMPORARY	42	45	4.178,00	4.874,00
2355	CONTEMPORARY	42		4.178,00	5.126,00
2362	CONTEMPORARY	26	215		1.095,00
2372	CONTEMPORARY	43	100		2.196,00
2374	CONTEMPORARY	43	101		1.734,00
2382	CONTEMPORARY	26	221	699,00	838,00
2384	CONTEMPORARY	26	219	619,00	758,00
2404	CONTEMPORARY	43	15	6.840,00	9.684,00
2404/N	CONTEMPORARY	43	13	6.840,00	8.928,00
2405	CONTEMPORARY	43		6.890,00	9.950,00
2414	CONTEMPORARY	43		3.530,00	4.952,00
2414/N	CONTEMPORARY	43		3.530,00	4.574,00
2415	CONTEMPORARY	43	19	3.560,00	5.090,00
2424	CONTEMPORARY	43		2.252,00	2.774,00
2424/N	CONTEMPORARY	43	21	2.252,00	2.963,00
2425	CONTEMPORARY	43		2.306,00	3.071,00
2426	CONTEMPORARY	43	25	3.269,00	3.980,00
2434	CONTEMPORARY	31	267	1.880,00	2.576,00
2434/N	CONTEMPORARY	31		1.880,00	2.828,00
2435	CONTEMPORARY	31		1.880,00	2.900,00
2444	CONTEMPORARY	37	273	992,00	1.476,00
2444/N	CONTEMPORARY	37	271	992,00	1.358,00
2445	CONTEMPORARY	37		992,00	1.468,00
2446	CONTEMPORARY	37	275	1.514,00	1.988,00
2450/A	CONTEMPORARY	27		556,00	872,00
2450/C	CONTEMPORARY	27		556,00	1.204,00
2450/P	CONTEMPORARY	27		556,00	872,00
2450/R	CONTEMPORARY	27		556,00	872,00
2451/A	CONTEMPORARY	27		556,00	872,00
2451/C	CONTEMPORARY	27		556,00	1.204,00
2451/P	CONTEMPORARY	27		556,00	872,00
2451/R	CONTEMPORARY	27		556,00	872,00
2452/A	CONTEMPORARY	27		606,00	922,00
2452/C	CONTEMPORARY	27	199	606,00	1.254,00
2452/P	CONTEMPORARY	27	195	606,00	922,00
2452/R	CONTEMPORARY	27		606,00	922,00
2453/A	CONTEMPORARY	27		516,00	832,00
2453/C	CONTEMPORARY	27		516,00	1.164,00
2453/P	CONTEMPORARY	27		516,00	832,00

LOVELY LIGHT

BAGA

LISTINO ANAGRAFICO

ARTICOLO	CATALOGO	PAG. LIST.	PAG. CAT.	PREZZO E	
		RIFERIMENTO	RIFERIMENTO	SOLO BASE	COMPLETO
2453/R	CONTEMPORARY	27		516,00	832,00
2454/A	CONTEMPORARY	27	196	516,00	832,00
2454/C	CONTEMPORARY	27	198	516,00	1.164,00
2454/P	CONTEMPORARY	27	194	516,00	832,00
2454/R	CONTEMPORARY	27	193	516,00	832,00
2455/A	CONTEMPORARY	27	197	516,00	832,00
2455/C	CONTEMPORARY	27		516,00	1.164,00
2455/P	CONTEMPORARY	27		516,00	832,00
2455/R	CONTEMPORARY	27	192	516,00	832,00
2460/A	CONTEMPORARY	31		880,00	1.196,00
2460/C	CONTEMPORARY	32		880,00	1.528,00
2460/P	CONTEMPORARY	31		880,00	1.196,00
2460/R	CONTEMPORARY	31		880,00	1.196,00
2461/A	CONTEMPORARY	31		880,00	1.196,00
2461/C	CONTEMPORARY	32		880,00	1.528,00
2461/P	CONTEMPORARY	31		880,00	1.196,00
2461/R	CONTEMPORARY	31		880,00	1.196,00
2462/A	CONTEMPORARY	31		930,00	1.296,00
2462/C	CONTEMPORARY	32		930,00	1.578,00
2462/P	CONTEMPORARY	31		930,00	1.296,00
2462/R	CONTEMPORARY	31		930,00	1.296,00
2463/A	CONTEMPORARY	31		740,00	1.056,00
2463/C	CONTEMPORARY	32		740,00	1.388,00
2463/P	CONTEMPORARY	31		740,00	1.056,00
2463/R	CONTEMPORARY	31		740,00	1.056,00
2464/A	CONTEMPORARY	31	247	740,00	1.056,00
2464/C	CONTEMPORARY	32	253	740,00	1.388,00
2464/P	CONTEMPORARY	31	251	740,00	1.056,00
2464/R	CONTEMPORARY	31	249	740,00	1.056,00
2465/A	CONTEMPORARY	31		740,00	1.056,00
2465/C	CONTEMPORARY	32		740,00	1.388,00
2465/P	CONTEMPORARY	31		740,00	1.056,00
2465/R	CONTEMPORARY	31		740,00	1.056,00
2472	CONTEMPORARY	43	111		828,00
2482	CONTEMPORARY	32	259		1.788,00
2492	CONTEMPORARY	27	213		1.480,00
3081	CONTEMPORARY	44	29	3.862,00	7.742,00
3083	CONTEMPORARY	37	285	1.976,00	3.272,00
3087	CONTEMPORARY	28	203	1.004,00	1.814,00
3101	PROGRESS	14		2.435,00	2.858,00
3103	PROGRESS	14		2.211,00	2.634,00
3104	PROGRESS	14	51	2.211,00	2.634,00
3111	PROGRESS	14	53	1.853,00	2.135,00
3113	PROGRESS	14		1.708,00	1.990,00
3114	PROGRESS	14		1.708,00	1.990,00
3121	PROGRESS	14	57	1.384,00	1.525,00
3123	PROGRESS	14	55	1.135,00	1.276,00
3124	PROGRESS	14		1.135,00	1.276,00
3131	PROGRESS	12		704,00	836,00
3133	PROGRESS	12	71	653,00	794,00
3134	PROGRESS	12	73	653,00	794,00
3141	PROGRESS	12	69	572,00	666,00
3143	PROGRESS	12	67	525,00	619,00
3144	PROGRESS	12		525,00	619,00
3150	PROGRESS	14	11		4.298,00
3151	PROGRESS	14	5		4.218,00
3154	PROGRESS	14	7		4.160,00
3156	PROGRESS	15	93		3.126,00
3157	PROGRESS	15			3.054,00
3158	PROGRESS	15			2.944,00
3160	PROGRESS	15			2.220,00
3161	PROGRESS	15			2.180,00
3164	PROGRESS	15	13		2.160,00
3170	PROGRESS	15			1.470,00
3171	PROGRESS	15	15		1.380,00
3174	PROGRESS	15			1.320,00
3180	PROGRESS	12	83		1.187,00
3181	PROGRESS	12			1.180,00
3184	PROGRESS	12	85		1.170,00
3190	PROGRESS	12	89		862,00
3191	PROGRESS	12	87		818,00
3194	PROGRESS	12			775,00
3200	PROGRESS	15	95		1.265,00
3201	PROGRESS	15			1.215,00
3204	PROGRESS	15	97		1.155,00
3210	PROGRESS	15	99		910,00
3211	PROGRESS	15			840,00
3214	PROGRESS	15			834,00
3220	PROGRESS	15		1.593,00	1.965,00
3224	PROGRESS	15	31	1.512,00	1.886,00
3230	PROGRESS	16	33	1.318,00	1.666,00
3234	PROGRESS	16		1.246,00	1.594,00
3240sx	PROGRESS	12	102	284,00	342,00
3240dx	PROGRESS	12	103	284,00	342,00
3244sx	PROGRESS	13	104	260,00	318,00
3244dx	PROGRESS	13	105	260,00	318,00
3250	PROGRESS	13	109	346,00	404,00
3254	PROGRESS	13	111	309,00	367,00

ARTICOLO	CATALOGO	PAG. LIST.	PAG. CAT.	PREZZO E	
		RIFERIMENTO	RIFERIMENTO	SOLO BASE	COMPLETO
3260	PROGRESS	16	19	2.952,00	3.996,00
3264	PROGRESS	16	21	2.624,00	3.668,00
3266	COLLECTIONS BOOK	16	16	4.756,00	6.196,00
3268	COLLECTIONS BOOK	16	17	4.550,00	5.990,00
3270	PROGRESS	16	27	1.934,00	2.630,00
3274	PROGRESS	16	25	1.842,00	2.538,00
3280	PROGRESS	13	77	962,00	1.310,00
3284	PROGRESS	13	79	932,00	1.280,00
3286	COLLECTIONS BOOK	13	46	1.450,00	1.990,00
3288	COLLECTIONS BOOK	13	47	1.360,00	1.900,00
3291	PROGRESS	16	61	874,00	1.106,00
3294	PROGRESS	16	63	816,00	1.048,00
3301	PROGRESS	9	147	638,00	754,00
3304	PROGRESS	9		564,00	680,00
3311	PROGRESS	9	145	842,00	1.074,00
3314	PROGRESS	9		788,00	1.020,00
3321	PROGRESS	10	143	1.330,00	1.562,00
3324	PROGRESS	10	142	1.166,00	1.398,00
3331	PROGRESS	19	149		294,00
3334	PROGRESS	19	148		256,00
3341	PROGRESS	19	151		209,00
3344	PROGRESS	19	151		186,00
3351	PROGRESS	19	151		209,00
3354	PROGRESS	19	151		186,00
3361	PROGRESS	16	39		1.522,00
3364	PROGRESS	16	41		1.362,00
3371	PROGRESS	17	43		1.357,00
3374	PROGRESS	17	42		1.198,00
3381	PROGRESS	17	47		1.226,00
3384	PROGRESS	17	45		1.094,00
3390	PROGRESS	17	35		2.652,00
3402	PROGRESS	10	121	1.596,00	1.692,00
3404	PROGRESS	10	120	1.518,00	1.614,00
3412	PROGRESS	10	122	1.627,00	1.748,00
3414	PROGRESS	10	123	1.531,00	1.652,00
3422	PROGRESS	10	127	1.980,00	2.076,00
3424	PROGRESS	10	126	1.902,00	1.998,00
3432	PROGRESS	11	128	2.011,00	2.132,00
3434	PROGRESS	11	129	1.915,00	2.036,00
3442	PROGRESS	11	133	1.149,00	1.245,00
3444	PROGRESS	11	132	1.029,00	1.125,00
3452	PROGRESS	11	134	1.533,00	1.629,00
3454	PROGRESS	11	135	1.413,00	1.509,00
3464	PROGRESS	9	115	1.156,00	1.270,00
3474	PROGRESS	11	117	1.331,00	1.445,00
3481	PROGRESS	19	154		475,00
3484	PROGRESS	19	155		380,00
3491	PROGRESS	19	156		798,00
3494	PROGRESS	19	157		595,00
3502	COLLECTIONS BOOK	11	77	2.685,00	2.781,00
5002	CONTEMPORARY	21		166,00	328,00
5003	CONTEMPORARY	21		166,00	328,00
5004	CONTEMPORARY	21		166,00	328,00
5012	CONTEMPORARY	22		166,00	328,00
5013	CONTEMPORARY	22		166,00	328,00
5014	CONTEMPORARY	22		166,00	328,00
5022	CONTEMPORARY	22		166,00	328,00
5023	CONTEMPORARY	22		166,00	328,00
5024	CONTEMPORARY	22		166,00	328,00
5032	CONTEMPORARY	22		166,00	328,00
5033	CONTEMPORARY	22		166,00	328,00
5034	CONTEMPORARY	22		166,00	328,00
5040	CONTEMPORARY	22		166,00	245,00
5041	CONTEMPORARY	22		166,00	245,00
5042	CONTEMPORARY	22		166,00	245,00
5043	CONTEMPORARY	22		166,00	245,00
5044	CONTEMPORARY	22		166,00	245,00
5050	CONTEMPORARY	22		166,00	245,00
5051	CONTEMPORARY	22		166,00	245,00
5052	CONTEMPORARY	22		166,00	245,00
5053	CONTEMPORARY	22		166,00	245,00
5054	CONTEMPORARY	22		166,00	245,00
5060	CONTEMPORARY	22		166,00	245,00
5061	CONTEMPORARY	22		166,00	245,00
5062	CONTEMPORARY	22		166,00	245,00
5063	CONTEMPORARY	22		166,00	245,00
5064	CONTEMPORARY	22		166,00	245,00
5070	CONTEMPORARY	23		166,00	245,00
5071	CONTEMPORARY	23		166,00	245,00
5072	CONTEMPORARY	23		166,00	245,00
5073	CONTEMPORARY	23		166,00	245,00
5074	CONTEMPORARY	23		166,00	245,00
5080	CONTEMPORARY	24		166,00	245,00
5081	CONTEMPORARY	24		166,00	245,00
5082	CONTEMPORARY	24		166,00	245,00
5083	CONTEMPORARY	24		166,00	245,00
5084	CONTEMPORARY	24		166,00	245,00
5085	CONTEMPORARY	24		166,00	245,00

ARTICOLO	CATALOGO	PAG. LIST.	PAG. CAT.	PREZZO E	
		RIFERIMENTO	RIFERIMENTO	SOLO BASE	COMPLETO
5090	CONTEMPORARY	24		166,00	245,00
5091	CONTEMPORARY	24		166,00	245,00
5092	CONTEMPORARY	24		166,00	245,00
5093	CONTEMPORARY	24		166,00	245,00
5094	CONTEMPORARY	24		166,00	245,00
5095	CONTEMPORARY	24		166,00	245,00
5100	CONTEMPORARY	24		166,00	245,00
5101	CONTEMPORARY	24		166,00	245,00
5102	CONTEMPORARY	24		166,00	245,00
5103	CONTEMPORARY	24		166,00	245,00
5104	CONTEMPORARY	24		166,00	245,00
5105	CONTEMPORARY	24		166,00	245,00
5110	CONTEMPORARY	25		166,00	245,00
5111	CONTEMPORARY	25		166,00	245,00
5112	CONTEMPORARY	25		166,00	245,00
5113	CONTEMPORARY	25		166,00	245,00
5114	CONTEMPORARY	25		166,00	245,00
5115	CONTEMPORARY	25		166,00	245,00
5120	CONTEMPORARY	23	185	166,00	245,00
5121	CONTEMPORARY	23		166,00	245,00
5122	CONTEMPORARY	23		166,00	245,00
5123	CONTEMPORARY	23		166,00	245,00
5124	CONTEMPORARY	23		166,00	245,00
5125	CONTEMPORARY	23		166,00	245,00
5130	CONTEMPORARY	24	185	166,00	245,00
5131	CONTEMPORARY	24		166,00	245,00
5132	CONTEMPORARY	24		166,00	245,00
5133	CONTEMPORARY	24		166,00	245,00
5134	CONTEMPORARY	24		166,00	245,00
5135	CONTEMPORARY	24		166,00	245,00
5140	CONTEMPORARY	24	185	166,00	245,00
5141	CONTEMPORARY	24		166,00	245,00
5142	CONTEMPORARY	24		166,00	245,00
5143	CONTEMPORARY	24		166,00	245,00
5144	CONTEMPORARY	24		166,00	245,00
5145	CONTEMPORARY	24		166,00	245,00
5150	CONTEMPORARY	24	185	166,00	245,00
5151	CONTEMPORARY	24		166,00	245,00
5152	CONTEMPORARY	24		166,00	245,00
5153	CONTEMPORARY	24		166,00	245,00
5154	CONTEMPORARY	24		166,00	245,00
5155	CONTEMPORARY	24		166,00	245,00
5160	CONTEMPORARY	23		166,00	245,00
5162	CONTEMPORARY	23		166,00	245,00
5163	CONTEMPORARY	23		166,00	245,00
5164	CONTEMPORARY	23		166,00	245,00
5165	CONTEMPORARY	23		166,00	245,00
5170	CONTEMPORARY	23		166,00	245,00
5172	CONTEMPORARY	23		166,00	245,00
5173	CONTEMPORARY	23		166,00	245,00
5174	CONTEMPORARY	23		166,00	245,00
5175	CONTEMPORARY	23		166,00	245,00
5180	CONTEMPORARY	23		166,00	245,00
5182	CONTEMPORARY	23		166,00	245,00
5183	CONTEMPORARY	23		166,00	245,00
5184	CONTEMPORARY	23		166,00	245,00
5185	CONTEMPORARY	23		166,00	245,00
5190	CONTEMPORARY	23		166,00	245,00
5192	CONTEMPORARY	23		166,00	245,00
5193	CONTEMPORARY	23		166,00	245,00
5194	CONTEMPORARY	23		166,00	245,00
5195	CONTEMPORARY	23		166,00	245,00
6011	CONTEMPORARY	30		520,00	648,00
6013	CONTEMPORARY	30		520,00	648,00
6015	CONTEMPORARY	30		520,00	648,00
6021	CONTEMPORARY	30		520,00	648,00
6023	CONTEMPORARY	30		520,00	648,00
6025	CONTEMPORARY	30		520,00	648,00
6030	CONTEMPORARY	31		520,00	648,00
6031	CONTEMPORARY	31		520,00	648,00
6032	CONTEMPORARY	31		595,00	723,00
6033	CONTEMPORARY	31		520,00	648,00
6034	CONTEMPORARY	31		520,00	648,00
6035	CONTEMPORARY	31		520,00	648,00
6040	CONTEMPORARY	31		520,00	648,00
6041	CONTEMPORARY	31		520,00	648,00
6042	CONTEMPORARY	31		595,00	723,00
6043	CONTEMPORARY	31		520,00	648,00
6044	CONTEMPORARY	31		520,00	648,00
6045	CONTEMPORARY	31		520,00	648,00
6051	CONTEMPORARY	30		520,00	648,00
6053	CONTEMPORARY	30		520,00	648,00
6055	CONTEMPORARY	30		520,00	648,00
6061	CONTEMPORARY	30		520,00	648,00
6063	CONTEMPORARY	30		520,00	648,00
6065	CONTEMPORARY	30		520,00	648,00
AP20	25° ANNIVERSARY	108	292	163,00	385,00
AP21	25° ANNIVERSARY	108	292	163,00	385,00

ARTICOLO	CATALOGO	PAG. LIST.	PAG. CAT.	PREZZO E	
		RIFERIMENTO	RIFERIMENTO	SOLO BASE	COMPLETO
AP22	25° ANNIVERSARY	108	292	217,00	515,00
AP23	25° ANNIVERSARY	108	294	217,00	420,00
AP24	25° ANNIVERSARY	108	294	217,00	420,00
AP25	25° ANNIVERSARY	108	294	308,00	560,00
AP26	25° ANNIVERSARY	108	296	262,00	468,00
AP27	25° ANNIVERSARY	108	296	262,00	468,00
AP28	25° ANNIVERSARY	108	296	378,00	610,00
CM19	25° ANNIVERSARY	104	322		660,00
CM22	25° ANNIVERSARY	104	323		362,00
CM273	25° ANNIVERSARY	104	318		894,00
CM284/2	25° ANNIVERSARY	104	319		1.380,00
CM284/3	25° ANNIVERSARY	104	319		895,00
CM284/4	25° ANNIVERSARY	104	319		645,00
CM287	25° ANNIVERSARY	105	321		1.965,00
CM292	25° ANNIVERSARY	105	316		1.838,00
CM355	25° ANNIVERSARY	105	317		1.920,00
CM365	25° ANNIVERSARY	105	325		323,00
CM373	25° ANNIVERSARY	105	307	529,00	965,00
CM374	25° ANNIVERSARY	105	307	280,00	564,00
CM375	25° ANNIVERSARY	106	309	642,00	920,00
CM376	25° ANNIVERSARY	106	301	362,00	638,00
CM377	25° ANNIVERSARY	106	301	362,00	638,00
CM378	25° ANNIVERSARY	106	299	597,00	875,00
CM379	25° ANNIVERSARY	106	299	295,00	520,00
CM381	25° ANNIVERSARY	106	311	684,00	930,00
CM401	25° ANNIVERSARY	107	324	370,00	510,00
CM401/O	25° ANNIVERSARY	107	324		210,00
CM402	25° ANNIVERSARY	107	324	385,00	580,00
CM402/O	25° ANNIVERSARY	107	324		237,00
CM403	25° ANNIVERSARY	107	325	550,00	795,00
CM403/O	25° ANNIVERSARY	107	325		385,00
CM404	25° ANNIVERSARY	107	305	688,00	936,00
CM405	25° ANNIVERSARY	107	303	855,00	1.085,00
CM435	25° ANNIVERSARY	107	313		1.737,00
CM436	25° ANNIVERSARY	108	312		2.578,00
CM437	25° ANNIVERSARY	108	314		555,00
CM438	25° ANNIVERSARY	108	315		866,00
CM492	XXI CENTURY	69	136		2.220,00
CM493	XXI CENTURY	69	137		2.220,00
CM494	XXI CENTURY	69	136		2.220,00
CM495	XXI CENTURY	69	136		2.220,00
CM496	XXI CENTURY	69	136		2.220,00
CM497	XXI CENTURY	69	136		2.220,00
CM498	XXI CENTURY	69	131	1.285,00	1.820,00
CM499	XXI CENTURY	69	58	1.285,00	1.675,00
CM500	XXI CENTURY	69	73	1.285,00	1.675,00
CM501	XXI CENTURY	69	119	1.285,00	1.675,00
CM502	XXI CENTURY	69	68	1.285,00	1.820,00
CM503	XXI CENTURY	69	101	1.285,00	1.820,00
CM504	XXI CENTURY	69	126	648,00	931,00
CM505	XXI CENTURY	69	115	648,00	931,00
CM506	XXI CENTURY	69	69	648,00	931,00
CM507	XXI CENTURY	70	83	920,00	1.203,00
CM508	XXI CENTURY	70	55	920,00	1.203,00
CM509	XXI CENTURY	70	124	920,00	1.203,00
CM510	XXI CENTURY	70	45	726,00	996,00
CM511	XXI CENTURY	70	129	726,00	996,00
CM512	XXI CENTURY	70	66	726,00	996,00
CM513	XXI CENTURY	70	78	628,00	886,00
CM514	XXI CENTURY	70	122	628,00	886,00
CM515	XXI CENTURY	70	98	628,00	886,00
CM516	XXI CENTURY	71	78	304,00	497,00
CM517	XXI CENTURY	71	111	304,00	497,00
CM518	XXI CENTURY	71	98	304,00	497,00
CM519	XXI CENTURY	71	57	713,00	996,00
CM520	XXI CENTURY	71	81	713,00	996,00
CM521	XXI CENTURY	71	65	713,00	996,00
CM522	XXI CENTURY	71	57	350,00	548,00
CM523	XXI CENTURY	71	81	350,00	548,00
CM524	XXI CENTURY	71	65	350,00	548,00
CM525	XXI CENTURY	72	44	247,00	445,00
CM526	XXI CENTURY	72	54	247,00	445,00
CM527	XXI CENTURY	72	71	247,00	445,00
CM528	XXI CENTURY	71	124	713,00	996,00
CM530	XXI CENTURY	69	100	648,00	931,00
CM531	XXI CENTURY	69	61	648,00	931,00
CM532	XXI CENTURY	69	83	648,00	931,00
CM533	XXI CENTURY	70	121	920,00	1.203,00
CM534	XXI CENTURY	70	109	920,00	1.203,00
CM535	XXI CENTURY	70	105	920,00	1.203,00
CM536	XXI CENTURY	70	106	726,00	996,00
CM537	XXI CENTURY	70	51	726,00	996,00
CM538	XXI CENTURY	70	123	726,00	996,00
CM539	XXI CENTURY	70	110	628,00	886,00
CM540	XXI CENTURY	70	56	628,00	886,00
CM541	XXI CENTURY	70	132	628,00	886,00
CM542	XXI CENTURY	71	56	304,00	497,00
CM543	XXI CENTURY	71	122	304,00	497,00



P r o g r e s s

BAGA
L O V E L Y L I G H T

LAMPADARE DA TAVOLO

PIANTANE

APPLIQUES

LAMPADARI E PLAFONIERE

PORTACANDELE

LOVELY LIGHT

BAGA

ARTICOLO PAG. CAT. FINITURA PARALUME PENDENTI PREZZO €
RIFERIMENTO SOLO BASE COMPLETO

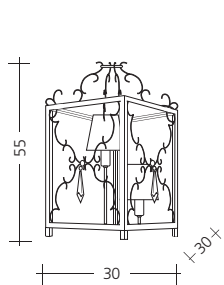

ø12X8 - H.11

 2x
 40W E.14
 NON FORNITE

 0,08
 Kg 7 (NETTO)

3301

147

ARGENTO FOGLIA

PELLE AVORIO

CRISTALLI TRASPARENTI
E NERI

638,00

754,00

3304

PIOMBO

PELLE NERA

CRISTALLI TRASPARENTI
E NERI

564,00

680,00

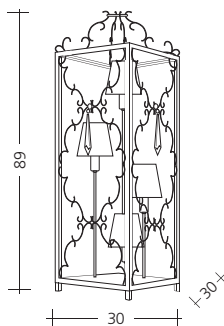

ø12X8 - H.11

 4x
 40W E.14
 NON FORNITE

 0,19
 Kg 8,5 (NETTO)

3311

145

ARGENTO FOGLIA

PELLE AVORIO

CRISTALLI TRASPARENTI
E NERI

842,00

1.074,00

3314

PIOMBO

PELLE NERA

CRISTALLI TRASPARENTI
E NERI

788,00

1.020,00

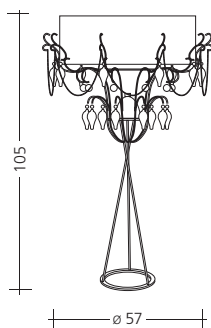

ø48 - H.16

 9x
 40W E.14
 NON FORNITE

 0,64
 Kg 6,2 (NETTO)

3464

115

PIOMBO

PELLE NERA

CRISTALLI TRASPARENTI
E NERI, CATENELLE
NICHEL

1.156,00

1.270,00

LAMPADARE DA TAVOLO

PIANTANE











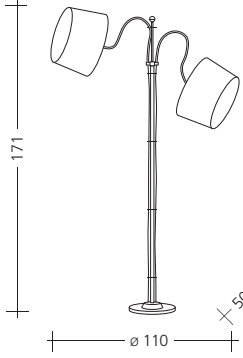



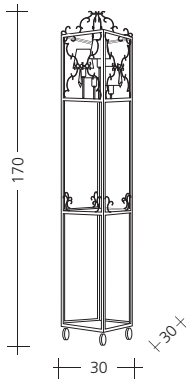



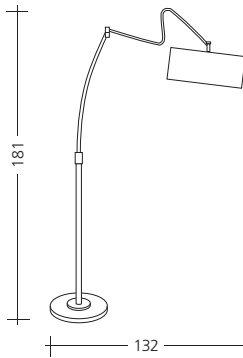

APPLIQUES

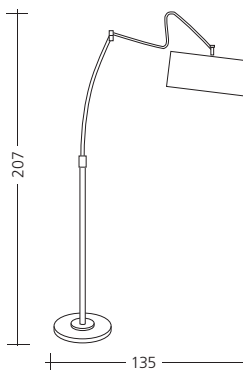
LAMPADARI E PLAFONIERE

PORTACANDELE

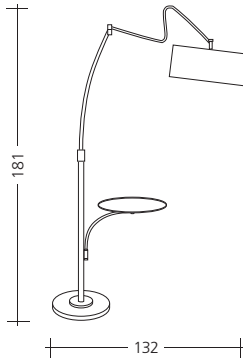
LOVELY LIGHT

BAGA

		ARTICOLO	PAG. CAT. RIFERIMENTO	FINITURA	PARALUME	PENDENTI	PREZZO €	
							SOLO BASE	COMPLETO
 <p>171</p> <p>ø 110</p> <p>+50</p>	 <p>ø44 - H.17</p>	685/PN	139	PIOMBO E NICHEL	PELLE NERA		1.198,00	1.390,00
	 <p>2x 100W E.27 NON FORNITE</p>							
	 <p>0,43</p>	686/PA	138	NICHEL	PELLE AVORIO		1.198,00	1.411,00
	 <p>0,52</p>							
	<p>Kg 11,2 (NETTO)</p>							
 <p>170</p> <p>30</p> <p>+30</p>	 <p>ø12X8 - H.11</p>	3321	143	ARGENTO FOGLIA	PELLE AVORIO	CRISTALLI TRASPARENTI E NERI	1.330,00	1.562,00
	 <p>4x 40W E.14 NON FORNITE</p>							
	 <p>0,34</p>	3324	142	PIOMBO	PELLE NERA	CRISTALLI TRASPARENTI E NERI	1.166,00	1.398,00
	<p>Kg 16,5 (NETTO)</p>							
 <p>181</p> <p>132</p>	 <p>ø44 - H.17</p>	3402	121	NICHEL	PELLE AVORIO		1.596,00	1.692,00
	 <p>1x 100W E.27 NON FORNITA</p>							
	 <p>0,34</p>	3404	120	PIOMBO E NICHEL	PELLE NERA		1.518,00	1.614,00
	 <p>0,34</p>							
	<p>Kg 18,5 (NETTO)</p>							
 <p>207</p> <p>135</p>	 <p>ø50 - H.18</p>	3412	122	NICHEL	PELLE AVORIO		1.627,00	1.748,00
	 <p>4x 40W E.14 NON FORNITE</p>							
	 <p>0,34</p>	3414	123	PIOMBO E NICHEL	PELLE NERA		1.531,00	1.652,00
	 <p>0,34</p>							
	<p>Kg 20 (NETTO)</p>							
 <p>181</p> <p>132</p>	 <p>ø44 - H.17</p>	3422	127	NICHEL	PELLE AVORIO		1.980,00	2.076,00
	 <p>1x 100W E.27 NON FORNITA</p>							
	 <p>0,34</p>	3424	126	PIOMBO E NICHEL	PELLE NERA		1.902,00	1.998,00
	 <p>0,34</p>							
	<p>Kg 22 (NETTO)</p>							

LOVELY LIGHT

BAGA

ARTICOLO PAG. CAT. RIFERIMENTO FINITURA PARALUME PENDENTI PREZZO € SOLO BASE COMPLETO

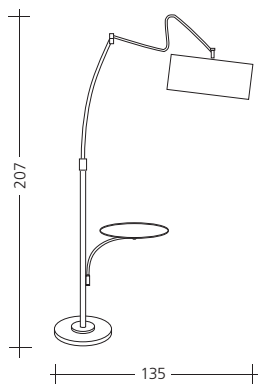

ø50 - H.18
4x
40W E.14
NON FORNITE
0,34 0,34
Kg 23 (NETTO)

3432

128

NICHEL

PELLE AVORIO

2.011,00

2.132,00

3434

129

PIOMBO E NICHEL

PELLE NERA

1.915,00

2.036,00

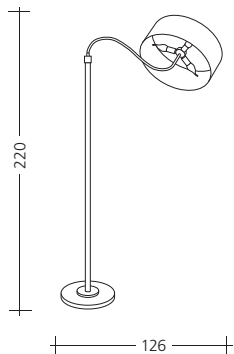

ø44 - H.18
3x
40W E.14
NON FORNITE
0,52
Kg 20 (NETTO)

3442

133

NICHEL

PELLE AVORIO

1.149,00

1.245,00

3444

132

PIOMBO E NICHEL

PELLE NERA

1.029,00

1.125,00

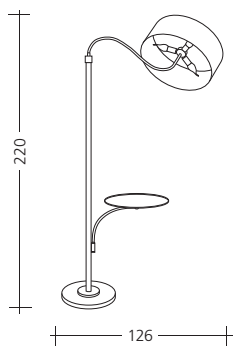

ø44 - H.18
3x
40W E.14
NON FORNITE
0,52
Kg 22 (NETTO)

3452

134

NICHEL

PELLE AVORIO

1.533,00

1.629,00

3454

135

PIOMBO E NICHEL

PELLE NERA

1.413,00

1.509,00

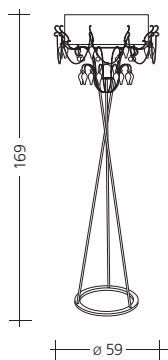

ø48 - H.16
9x
40W E.14
NON FORNITE
0,54 0,34
Kg 11,5 (NETTO)

3474

117

PIOMBO

PELLE NERA

CRISTALLI TRASPARENTI
E NERI
CATENELLE NICHEL

1.331,00

1.445,00

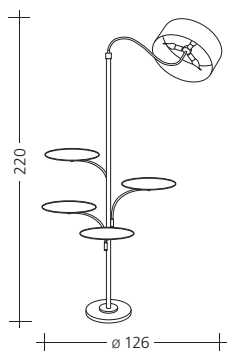

ø44 - H.18
3x
40W E.14
NON FORNITE
0,52 0,43
Kg 28 (NETTO)

3502

77

NICHEL

PELLE NERA

COLL. BOOK

2.685,00

2.781,00











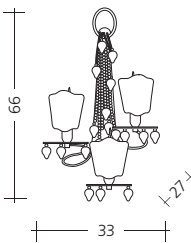



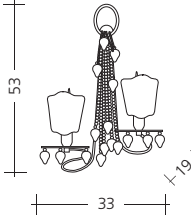



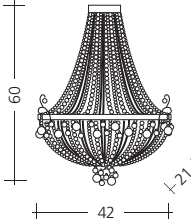



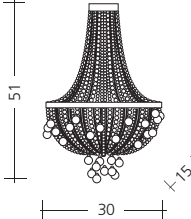

LAMPADARE DA TAVOLO

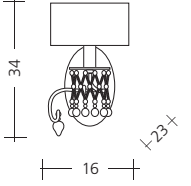
PIANTANE

APPLIQUES

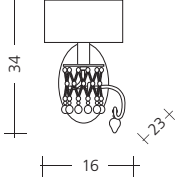
LAMPADARI E PLAFONIERE

PORTACANDELE

		ARTICOLO	PAG. CAT. RIFERIMENTO	FINITURA	PARALUME	PENDENTI	PREZZO €	
							SOLO BASE	COMPLETO
 <p>66 33 L-27+</p>	 ø10 - H.12 3131			ARGENTO FOGLIA	VENTOLE IN PELLE AVORIO	CRISTALLI TRASPARENTI E NERI	704,00	836,00
	 3x 40W E.14 NON FORNITE 3133	71	AVORIO	VENTOLE IN PELLE AVORIO	CRISTALLI TRASPARENTI	653,00	794,00	
	 0,22 3134 KG 2,6 (NETTO)	73	PIOMBO	VENTOLE IN PELLE NERA	CRISTALLI TRASPARENTI E NERI	653,00	794,00	
 <p>53 33 L-19+</p>	 ø10 - H.12 3141	69	ARGENTO	VENTOLE IN PELLE AVORIO	CRISTALLI TRASPARENTI E NERI	572,00	666,00	
	 2x 40W E.14 NON FORNITE 3143	67	AVORIO	VENTOLE IN PELLE AVORIO	CRISTALLI TRASPARENTI	525,00	619,00	
	 0,22 3144 KG 2 (NETTO)		PIOMBO	VENTOLE IN PELLE NERA	CRISTALLI TRASPARENTI E NERI	525,00	619,00	
 <p>60 42 L-21+</p>	 5x 40W E.14 NON FORNITE 3180	83	ORO FOGLIA		CRISTALLI TRASPARENTI ED AMBRA		1.187,00	
	 5x 40W E.14 NON FORNITE 3181		ARGENTO FOGLIA		CRISTALLI TRASPARENTI, NERI E MELANGE AMETISTA		1.180,00	
	 0,22 3184 KG 5,2 (NETTO)	85	PIOMBO		CRISTALLI TRASPARENTI E NERI		1.170,00	
 <p>51 30 L-15+</p>	 3x 40W E.14 NON FORNITE 3190	89	ORO FOGLIA		CRISTALLI TRASPARENTI ED AMBRA		862,00	
	 3x 40W E.14 NON FORNITE 3191	87	ARGENTO FOGLIA		CRISTALLI TRASPARENTI, NERI E MELANGE AMETISTA		818,00	
	 0,22 3194 KG 3,5 (NETTO)		PIOMBO		CRISTALLI TRASPARENTI E NERI		775,00	
 <p>34 16 L-23+</p>	 ø16 - H.10 3240 sx	102	ORO FOGLIA	PVC ARGENTO CON FRANGIA AVORIO	CRISTALLI TRASPARENTI ED AMBRA	284,00	342,00	
	 1x 40W E.14 NON FORNITA 3240 sx							
	 0,08 3240 sx KG 1,2 (NETTO)							
 <p>34 16 L-23+</p>	 ø16 - H.10 3240 dx	103	ORO FOGLIA	PVC ARGENTO CON FRANGIA AVORIO	CRISTALLI TRASPARENTI ED AMBRA	284,00	342,00	
	 1x 40W E.14 NON FORNITA 3240 dx							
	 0,08 3240 dx KG 1,2 (NETTO)							

LOVELY LIGHT

BAGA

ARTICOLO PAG. CAT. RIFERIMENTO FINITURA PARALUME PENDENTI PREZZO € SOLO BASE COMPLETO

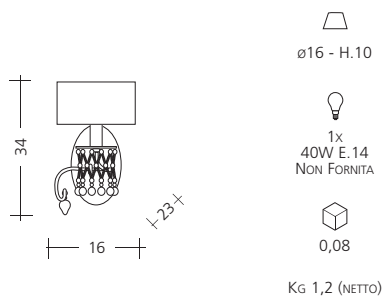

3244 SX

104

PIOMBO

PVC ARGENTO
CON FRANGIA AVORIO

CRISTALLI TRASPARENTI
E NERI

260,00

318,00

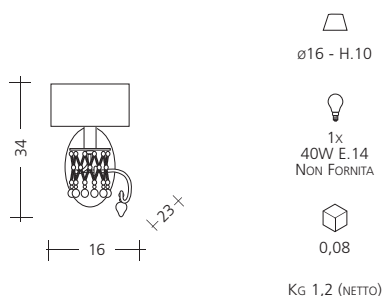

3244 DX

105

PIOMBO

PVC ARGENTO
CON FRANGIA AVORIO

CRISTALLI TRASPARENTI
E NERI

260,00

318,00

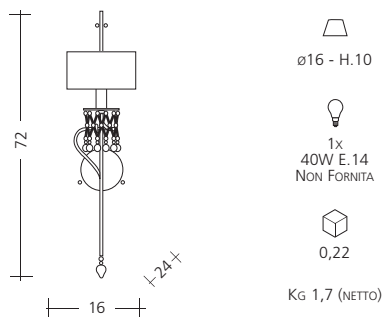

3250

109

ORO FOGLIA

PVC ARGENTO
CON FRANGIA AVORIO

CRISTALLI TRASPARENTI
ED AMBRA

346,00

404,00

3254

111

PIOMBO CON
DETTAGLI ARGENTO
FOGLIA

PVC ARGENTO
CON FRANGIA AVORIO

CRISTALLI TRASPARENTI
E NERI

309,00

367,00

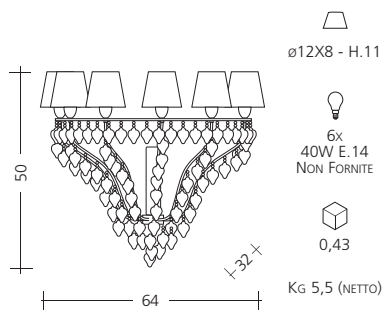

3280

77

ORO FOGLIA

PELLE NERA

CRISTALLI TRASPARENTI
ED AMBRA

962,00

1.310,00

3284

79

PIOMBO

PELLE NERA

CRISTALLI TRASPARENTI
E NERI

932,00

1.280,00

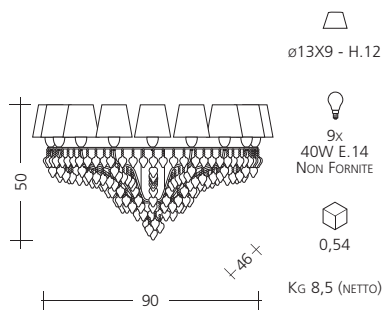

3286

46

ORO FOGLIA
COLL. BOOK

PELLE NERA

CRISTALLI TRASPARENTI
ED AMBRA

1.450,00

1.990,00

3288

47

PIOMBO
COLL. BOOK

PELLE NERA

CRISTALLI TRASPARENTI
E NERI

1.360,00

1.900,00

LAMPADARE DA TAVOLO

PIANTANE

APPLIQUES

LAMPADARI E PLAFONIERE

PORTACANDELE

LOVELY LIGHT

BAGA

ARTICOLO PAG. CAT. FINITURA PARALUME PENDENTI PREZZO €
SOLO BASE COMPLETO

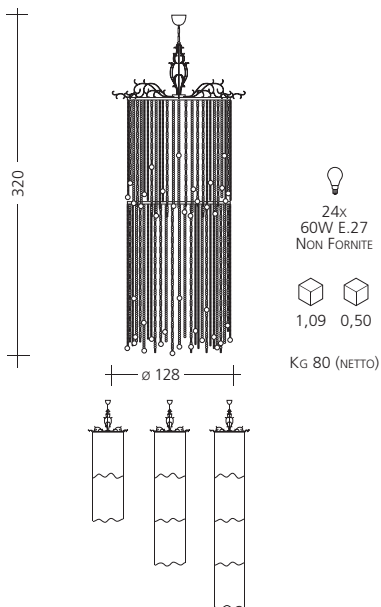

REALIZZABILE SU PROGETTO, CON DIAMETRO VARIABILE
E ALTEZZA MODULARE FINITURE E CRISTALLI DA
CONCORDARE

2178

23 PIOMBO
COLL. BOOK

CRISTALLI TRASPARENTI
PENDENTI NERI

14.874,00

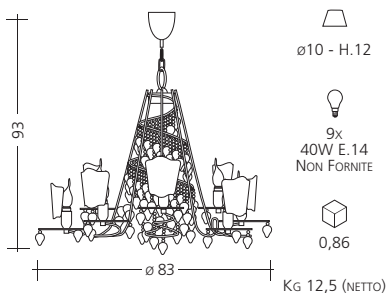

3101

ARGENTO FOGLIA

VENTOLE IN PELLE AVORIO

CRISTALLI TRASPARENTI
E NERI

2.435,00

2.858,00

3103

AVORIO

VENTOLE IN PELLE AVORIO

CRISTALLI TRASPARENTI

2.211,00

2.634,00

3104

51

PIOMBO

VENTOLE IN PELLE NERA

CRISTALLI TRASPARENTI
E NERI

2.211,00

2.634,00

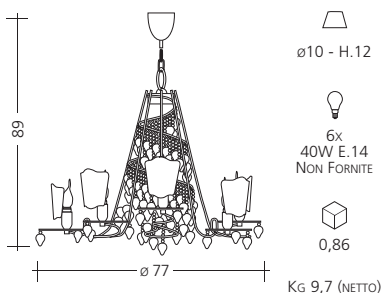

3111

53

ARGENTO FOGLIA

VENTOLE IN PELLE AVORIO

CRISTALLI TRASPARENTI
E NERI

1.853,00

2.135,00

3113

AVORIO

VENTOLE IN PELLE AVORIO

CRISTALLI TRASPARENTI

1.708,00

1.990,00

3114

PIOMBO

VENTOLE IN PELLE NERA

CRISTALLI TRASPARENTI
E NERI

1.708,00

1.990,00

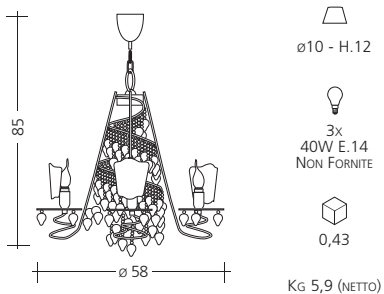

3121

57

ARGENTO FOGLIA

VENTOLE IN PELLE AVORIO

CRISTALLI TRASPARENTI
E NERI

1.384,00

1.525,00

3123

55

AVORIO

VENTOLE IN PELLE AVORIO

CRISTALLI TRASPARENTI

1.135,00

1.276,00

3124

PIOMBO

VENTOLE IN PELLE NERA

CRISTALLI TRASPARENTI
E NERI

1.135,00

1.276,00

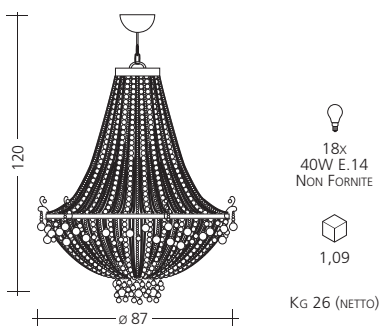

3150

11

ORO FOGLIA

CRISTALLI TRASPARENTI
ED AMBRA

4.298,00

3151

5

ARGENTO FOGLIA

CRISTALLI TRASPARENTI,
NERI E MELANGE AMETISTA

4.218,00

3154

7

PIOMBO

CRISTALLI TRASPARENTI
E NERI

4.160,00

LOVELY LIGHT

BAGA

ARTICOLO PAG. CAT. RIFERIMENTO FINITURA PARALUME PENDENTI PREZZO € SOLO BASE COMPLETO

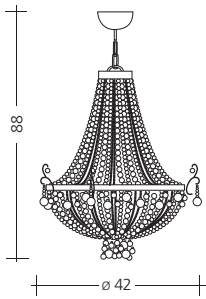

8x
40W E.14
NON FORNITE



0,40

KG 10,5 (NETTO)

3160

ORO FOGLIA

CRISTALLI TRASPARENTI
ED AMBRA

2.220,00

3161

ARGENTO FOGLIA

CRISTALLI TRASPARENTI,
NERI E MELANGE AMETISTA

2.180,00

3164

13

PIOMBO

CRISTALLI TRASPARENTI
E NERI

2.160,00

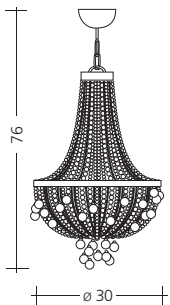

3x
40W E.14
NON FORNITE



0,19

KG 5,5 (NETTO)

3170

ORO FOGLIA

CRISTALLI TRASPARENTI
ED AMBRA

1.470,00

3171

15

ARGENTO FOGLIA

CRISTALLI TRASPARENTI,
NERI E MELANGE AMETISTA

1.380,00

3174

PIOMBO

CRISTALLI TRASPARENTI
E NERI

1.320,00

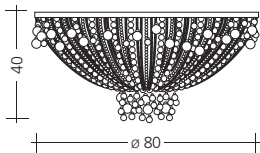

9x
40W E.14
NON FORNITE



0,50

KG 13 (NETTO)

3156

93

ORO FOGLIA

CRISTALLI TRASPARENTI
ED AMBRA

3.126,00

3157

ARGENTO FOGLIA

CRISTALLI TRASPARENTI,
NERI E MELANGE AMETISTA

3.054,00

3158

PIOMBO

CRISTALLI TRASPARENTI
E NERI

2.944,00

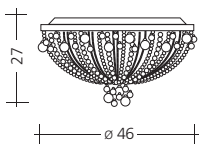

4x
40W E.14
NON FORNITE



0,17

KG 4,7 (NETTO)

3200

95

ORO FOGLIA

CRISTALLI TRASPARENTI
ED AMBRA

1.265,00

3201

ARGENTO FOGLIA

CRISTALLI TRASPARENTI,
NERI E MELANGE AMETISTA

1.215,00

3204

97

PIOMBO

CRISTALLI TRASPARENTI
E NERI

1.155,00

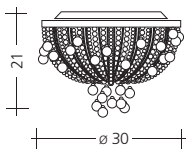

3x
40W E.14
NON FORNITE



0,08

KG 4 (NETTO)

3210

99

ORO FOGLIA

CRISTALLI TRASPARENTI
ED AMBRA

910,00

3211

ARGENTO FOGLIA

CRISTALLI TRASPARENTI,
NERI E MELANGE AMETISTA

840,00

3214

PIOMBO

CRISTALLI TRASPARENTI
E NERI

834,00

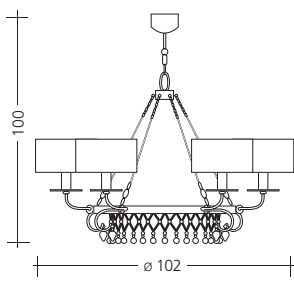

ø18 - H.11

6x
40W E.14
NON FORNITE



0,50

KG 8,5 (NETTO)

3220

ORO FOGLIA

PVC ARGENTO
CON FRANGIA AVORIO

CRISTALLI TRASPARENTI
ED AMBRA

1.593,00

1.965,00

3224

31

PIOMBO CON
DETTAGLI ARGENTO
FOGLIA

PVC ARGENTO
CON FRANGIA AVORIO

CRISTALLI TRASPARENTI
E NERI

1.512,00

1.886,00











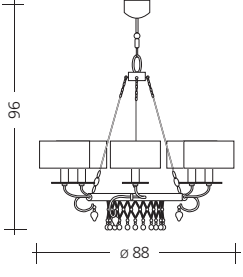



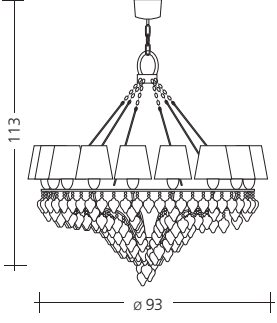



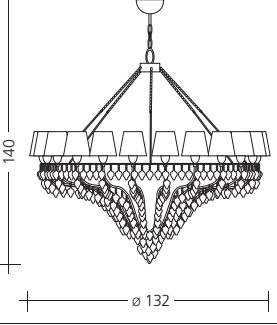



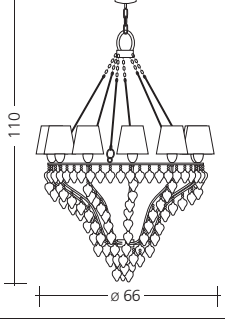

LAMPADARE DA TAVOLO

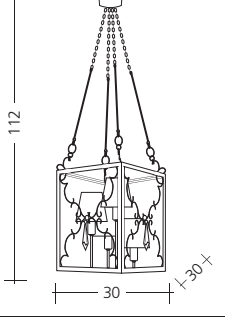
PIANTANE

APPLIQUES

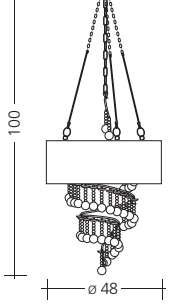
LAMPADARI E PLAFONIERE

PORTACANDELE

		ARTICOLO	PAG. CAT. RIFERIMENTO	FINITURA	PARALUME	PENDENTI	PREZZO €	
							SOLO BASE	COMPLETO
 <p>96</p> <p>ø 88</p>	 ø16 - H.10	3230	33	ORO FOGLIA	PVC ARGENTO CON FRANGIA AVORIO	CRISTALLI TRASPARENTI ED AMBRA	1.318,00	1.666,00
	 6x 40W E.14 NON FORNITE	 0,50 Kg 6,8 (NETTO)	3234		PIOMBO CON DETTAGLI ARGENTO FOGLIA	PVC ARGENTO CON FRANGIA AVORIO	CRISTALLI TRASPARENTI E NERI	1.246,00
 <p>113</p> <p>ø 93</p>	 ø12x8 - H.11	3260	19	ORO FOGLIA	PELLE NERA	CRISTALLI TRASPARENTI ED AMBRA	2.952,00	3.996,00
	 18x 40W E.14 NON FORNITE	 0,86 Kg 18 (NETTO)	3264	21	PIOMBO CON DETTAGLI NICHEL	PELLE NERA	CRISTALLI TRASPARENTI E NERI	2.624,00
 <p>140</p> <p>ø 132</p>	 ø13x9 - H.12	3266	16	ORO FOGLIA	PELLE NERA	CRISTALLI TRASPARENTI ED AMBRA	4.756,00	6.196,00
	 24x 40W E.14 NON FORNITE	 1,37 Kg 38 (NETTO)	3268	17	PIOMBO CON DETTAGLI NICHEL	PELLE NERA	CRISTALLI TRASPARENTI E NERI	4.550,00
 <p>110</p> <p>ø 66</p>	 ø12x8 - H.11	3270	27	ORO FOGLIA	PELLE NERA	CRISTALLI TRASPARENTI ED AMBRA	1.934,00	2.630,00
	 12x 40W E.14 NON FORNITE	 0,43 Kg 11,7 (NETTO)	3274	25	PIOMBO CON DETTAGLI NICHEL	PELLE NERA	CRISTALLI TRASPARENTI E NERI	1.842,00
 <p>112</p> <p>30</p> <p>30x</p>	 ø12x8 - H.11	3291	61	ARGENTO FOGLIA	PELLE AVORIO	CRISTALLI TRASPARENTI E NERI	874,00	1.106,00
	 4x 40W E.14 NON FORNITE	 0,08 Kg 5,8 (NETTO)	3294	63	PIOMBO CON DETTAGLI ARGENTO FOGLIA	PELLE NERA	CRISTALLI TRASPARENTI E NERI	816,00
 <p>100</p> <p>ø 48</p>	 ø48 - H.16	3361	39	ARGENTO FOGLIA	PELLE NERA	CRISTALLI TRASPARENTI E NERI		1.522,00
	 5x 40W E.14 NON FORNITE	 0,54 Kg 7,5 (NETTO)	3364	41	PIOMBO CON DETTAGLI ARGENTO FOGLIA	PVC ARGENTO	CRISTALLI TRASPARENTI	

LOVELY LIGHT

BAGA

ARTICOLO PAG. CAT. RIFERIMENTO FINITURA PARALUME PENDENTI PREZZO € SOLO BASE COMPLETO

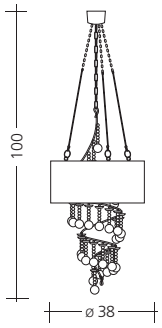

 ø38 - H.16

 3x
 40W E.14
 NON FORNITE

 0,54
 Kg 4,8 (NETTO)

3371

43

ARGENTO FOGLIA

PELLE NERA

CRISTALLI TRASPARENTI
E NERI

1.357,00

3374

42

PIOMBO CON
DETTAGLI ARGENTO
FOGLIA

PVC ARGENTO

CRISTALLI TRASPARENTI

1.198,00

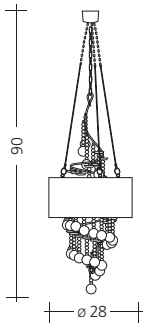

 ø28 - H.14

 1x
 40W E.27
 NON FORNITE

 0,54
 Kg 5,2 (NETTO)

3381

47

ARGENTO FOGLIA

PELLE NERA

CRISTALLI TRASPARENTI
E NERI

1.226,00

3384

45



PIOMBO CON
DETTAGLI ARGENTO
FOGLIA

PVC ARGENTO

CRISTALLI TRASPARENTI

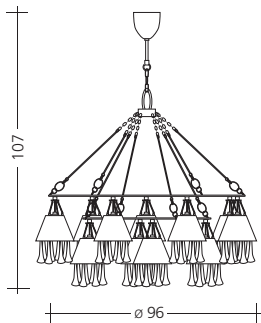
1.094,00



 ø15x7 - H.20

 15x
 40W E.14
 NON FORNITE

 0,50
 Kg 18 (NETTO)

3390

35

PIOMBO CON
DETTAGLI OTTONE

OTTONE CON
CRISTALLI MELANGE
AMETISTA

2.652,00

LAMPADARE DA TAVOLO

PIANTANE

APPLIQUES

LAMPADARI E PLAFONIERE

PORTACANDELE

LOVELYLIGHT

BAGA

ARTICOLO PAG. CAT. FINITURA PARALUME PENDENTI PREZZO €
RIFERIMENTO SOLO BASE COMPLETO

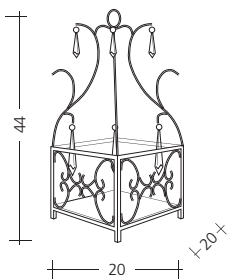

0,08
Kg 1,9 (NETTO)

3331 149 ARGENTO FOGLIA CRISTALLI TRASPARENTI E NERI **294,00**

3334 148 PIOMBO CRISTALLI TRASPARENTI E NERI **256,00**

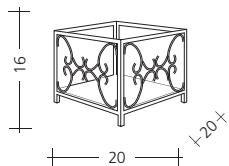

0,08
Kg 1,8 (NETTO)

3341 151 ARGENTO FOGLIA **209,00**

3344 151 PIOMBO **186,00**

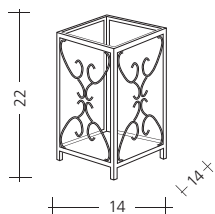

0,08
Kg 1,9 (NETTO)

3351 151 ARGENTO FOGLIA **209,00**

3354 151 PIOMBO **186,00**

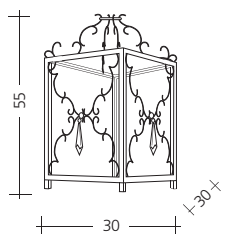

0,08
Kg 5,4 (NETTO)

3481 154 ARGENTO FOGLIA CRISTALLI TRASPARENTI E NERI **475,00**

3484 155 PIOMBO CRISTALLI TRASPARENTI E NERI **380,00**

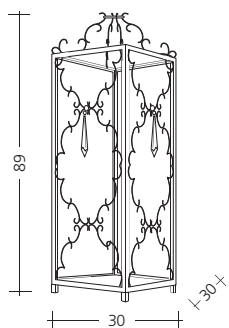

0,19
Kg 7 (NETTO)

3491 156 ARGENTO FOGLIA CRISTALLI TRASPARENTI E NERI **798,00**

3494 157 PIOMBO CRISTALLI TRASPARENTI E NERI **595,00**

LAMPADARE DA TAVOLO

PIANTANE

APPLIQUES

LAMPADARI E PLAFONIERE

PORTACANDELE

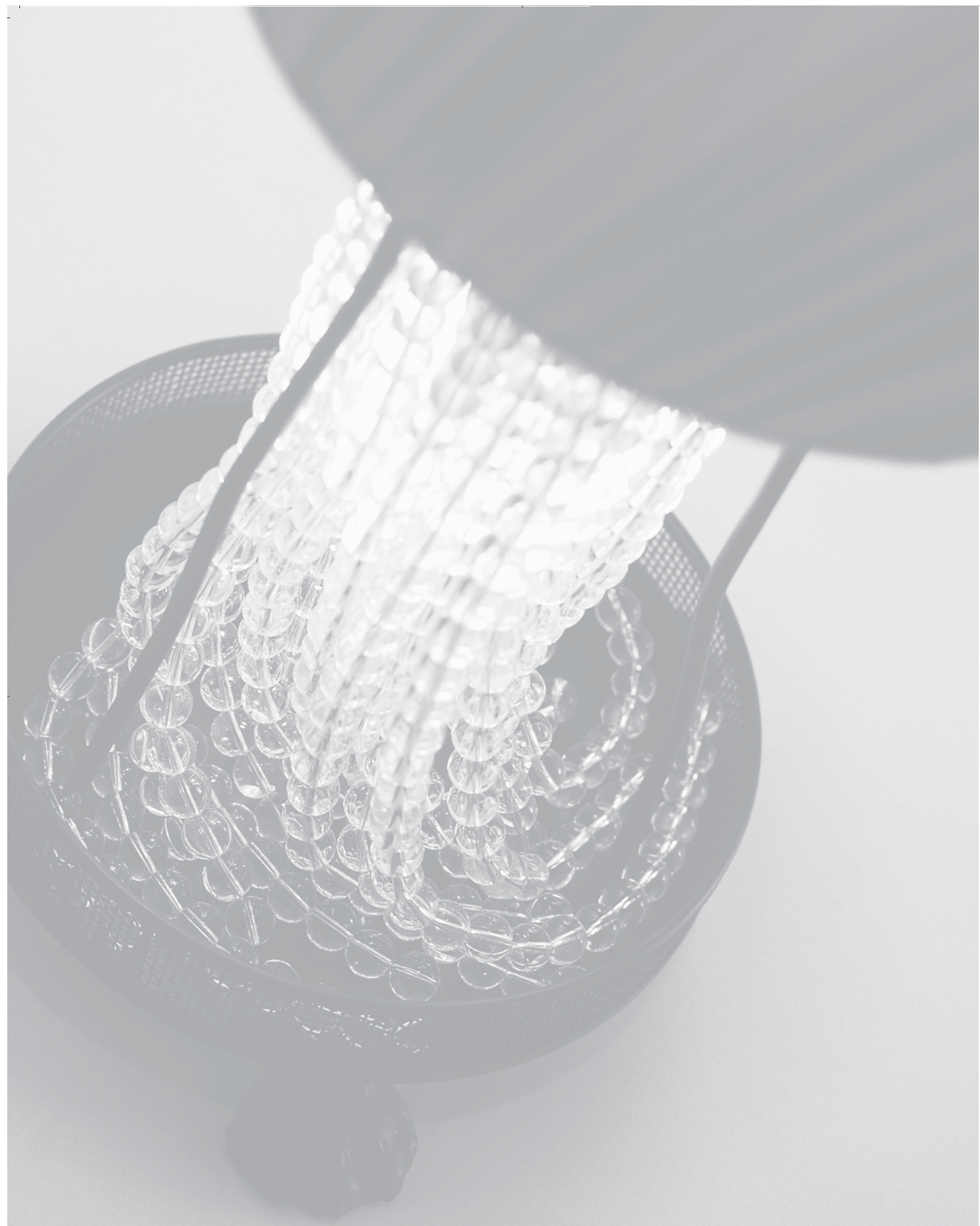

contemporary

COMPLEMENTI

LAMPADARI E PLAFONIERE

APPLIQUES

PIANTANE

LAMPADE DA TAVOLO

LOVELY LIGHT

BAGA

ARTICOLO PAG. CAT. FINITURA PARALUME PENDENTI PREZZO €
RIFERIMENTO SOLO BASE COMPLETO

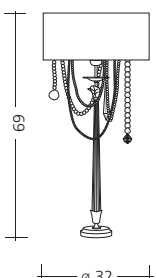
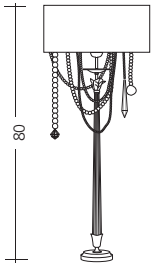
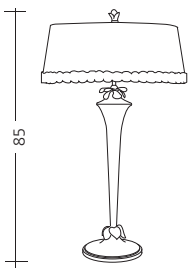
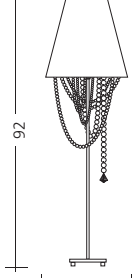
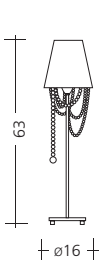
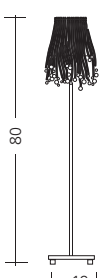
 <p>ø 32x32 - H. 14</p> <p>1x 40W E.14 NON FORNITA</p> <p>0,17</p> <p>Kg 2,2 (NETTO)</p>	<p>1041</p>	<p>229</p>	<p>NICHEL PARTICOLARI ARGENTO FOGLIA</p>	<p>TULLE AVORIO ARRICCIATO E CRISTALLI TRASPARENTI</p>	<p>476,00</p>	<p>737,00</p>
 <p>ø 32x32 - H. 14</p> <p>1x 40W E.14 NON FORNITA</p> <p>0,17</p> <p>Kg 2,2 (NETTO)</p>	<p>1042</p>	<p>229</p>	<p>NICHEL PARTICOLARI ARGENTO FOGLIA</p>	<p>TULLE AVORIO ARRICCIATO E CRISTALLI TRASPARENTI</p>	<p>503,00</p>	<p>764,00</p>
 <p>ø50x44 - H.18</p> <p>2x 60W E.27 NON FORNITE</p> <p>0,43</p> <p>Kg 4,3 (NETTO)</p>	<p>2056</p>	<p>231</p>	<p>AVORIO PARTICOLARI ARGENTO FOGLIA</p>	<p>CARTA BIANCA INTRECCIATA</p>	<p>582,00</p>	<p>715,00</p>
 <p>ø28X14 - H.28</p> <p>1x 40W E.14 FORNITA</p> <p>0,17</p> <p>Kg 2 (NETTO)</p>	<p>2058</p>	<p>225</p>	<p>ROSSO</p>	<p>TULLE AVORIO ARRICCIATO E CRISTALLI TRASPARENTI</p>	<p>166,00</p>	<p>498,00</p>
 <p>ø16X10 - H.16</p> <p>1x 40W E.14 FORNITA</p> <p>0,17</p> <p>Kg 1,5 (NETTO)</p>	<p>2059</p>	<p>225</p>	<p>ROSSO</p>	<p>TULLE AVORIO ARRICCIATO E CRISTALLI TRASPARENTI</p>	<p>166,00</p>	<p>398,00</p>
 <p>ø14X10 - H.24</p> <p>1x 40W E.14 FORNITA</p> <p>0,17</p> <p>Kg 2,3 (NETTO)</p>	<p>2081 2071 5002 5003 5004 2061</p>	<p>189</p>	<p>ORO FOGLIA ARGENTO FOGLIA NICHEL AVORIO PIOMBO ROSSO</p>	<p>CRISTALLI TRASPARENTI CRISTALLI TRASPARENTI CRISTALLI TRASPARENTI CRISTALLI TRASPARENTI CRISTALLI TRASPARENTI CRISTALLI TRASPARENTI</p>	<p>166,00 166,00 166,00 166,00 166,00 166,00</p>	<p>328,00 328,00 328,00 328,00 328,00 328,00</p>











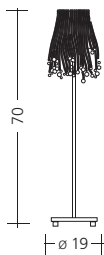



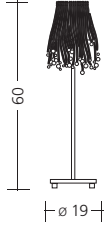



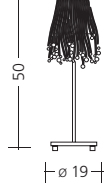



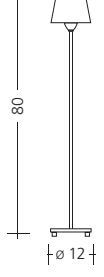

LAMPADARE DA TAVOLO

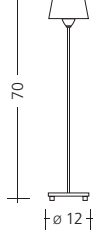
PIANTANE

APPLIQUES

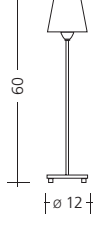
LAMPADARI E PLAFONIERE

COMPLEMENTI

		ARTICOLO	PAG. CAT. RIFERIMENTO	FINITURA	PARALUME	PENDENTI	PREZZO €	
							SOLO BASE	COMPLETO
 <p>70 ∅ 19</p>	 ∅14X10 - H.24  1x 40W E.14 FORNITE  0,17 KG 2,2 (NETTO)	2082	189	ORO FOGLIA	CRISTALLI TRASPARENTI		166,00	328,00
		2072		ARGENTO FOGLIA	CRISTALLI TRASPARENTI		166,00	328,00
		5012		NICHEL	CRISTALLI TRASPARENTI		166,00	328,00
		5013		AVORIO	CRISTALLI TRASPARENTI		166,00	328,00
		5014		PIOMBO	CRISTALLI TRASPARENTI		166,00	328,00
		2062		ROSSO	CRISTALLI TRASPARENTI		166,00	328,00
 <p>60 ∅ 19</p>	 ∅14X10 - H.24  1x 40W E.14 FORNITE  0,17 KG 2,1 (NETTO)	2083	189	ORO FOGLIA	CRISTALLI TRASPARENTI		166,00	328,00
		2073		ARGENTO FOGLIA	CRISTALLI TRASPARENTI		166,00	328,00
		5022		NICHEL	CRISTALLI TRASPARENTI		166,00	328,00
		5023		AVORIO	CRISTALLI TRASPARENTI		166,00	328,00
		5024		PIOMBO	CRISTALLI TRASPARENTI		166,00	328,00
		2063		ROSSO	CRISTALLI TRASPARENTI		166,00	328,00
 <p>50 ∅ 19</p>	 ∅14X10 - H.24  1x 40W E.14 FORNITE  0,17 KG 2 (NETTO)	2084	189	ORO FOGLIA	CRISTALLI TRASPARENTI		166,00	328,00
		2074		ARGENTO FOGLIA	CRISTALLI TRASPARENTI		166,00	328,00
		5032		NICHEL	CRISTALLI TRASPARENTI		166,00	328,00
		5033		AVORIO	CRISTALLI TRASPARENTI		166,00	328,00
		5034		PIOMBO	CRISTALLI TRASPARENTI		166,00	328,00
		2064		ROSSO	CRISTALLI TRASPARENTI		166,00	328,00
 <p>80 ∅ 12</p>	 ∅12X8 - H.11  1x 40W E.14 FORNITE  0,17 KG 1,8 (NETTO)	5040		ORO FOGLIA	TESSUTO ROSSO ARRICCIATO		166,00	245,00
		5041		ARGENTO FOGLIA	TESSUTO ROSSO ARRICCIATO		166,00	245,00
		5042		NICHEL	TESSUTO ROSSO ARRICCIATO		166,00	245,00
		5043		AVORIO	TESSUTO ROSSO ARRICCIATO		166,00	245,00
		5044		PIOMBO	TESSUTO ROSSO ARRICCIATO		166,00	245,00
		2065	183	ROSSO	TESSUTO ROSSO ARRICCIATO		166,00	245,00
 <p>70 ∅ 12</p>	 ∅12X8 - H.11  1x 40W E.14 NON FORNITE  0,17 KG 1,7 (NETTO)	5050		ORO FOGLIA	TESSUTO ROSSO ARRICCIATO		166,00	245,00
		5051		ARGENTO FOGLIA	TESSUTO ROSSO ARRICCIATO		166,00	245,00
		5052		NICHEL	TESSUTO ROSSO ARRICCIATO		166,00	245,00
		5053		AVORIO	TESSUTO ROSSO ARRICCIATO		166,00	245,00
		5054		PIOMBO	TESSUTO ROSSO ARRICCIATO		166,00	245,00
		2066	183	ROSSO	TESSUTO ROSSO ARRICCIATO		166,00	245,00
 <p>60 ∅ 12</p>	 ∅12X8 - H.11  1x 40W E.14 NON FORNITE  0,17 KG 1,6 (NETTO)	5060		ORO FOGLIA	TESSUTO ROSSO ARRICCIATO		166,00	245,00
		5061		ARGENTO FOGLIA	TESSUTO ROSSO ARRICCIATO		166,00	245,00
		5062		NICHEL	TESSUTO ROSSO ARRICCIATO		166,00	245,00
		5063		AVORIO	TESSUTO ROSSO ARRICCIATO		166,00	245,00
		5064		PIOMBO	TESSUTO ROSSO ARRICCIATO		166,00	245,00
		2067	183	ROSSO	TESSUTO ROSSO ARRICCIATO		166,00	245,00

LOVELY LIGHT

BAGA

ARTICOLO PAG. CAT. FINITURA PARALUME PENDENTI PREZZO €
RIFERIMENTO SOLO BASE COMPLETO

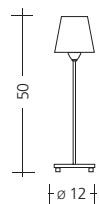

∅12X8 - H.11

1x
40W E.14
NON FORNITA

0,17

KG 1,5 (NETTO)

5070		ORO FOGLIA	TESSUTO ROSSO ARRICCIATO		166,00	245,00
5071		ARGENTO FOGLIA	TESSUTO ROSSO ARRICCIATO		166,00	245,00
5072		NICHEL	TESSUTO ROSSO ARRICCIATO		166,00	245,00
5073		AVORIO	TESSUTO ROSSO ARRICCIATO		166,00	245,00
5074		PIOMBO	TESSUTO ROSSO ARRICCIATO		166,00	245,00
2068	183	ROSSO	TESSUTO ROSSO ARRICCIATO		166,00	245,00

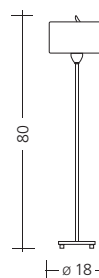

∅18X18 - H.10

1x
40W E.14
FORNITA

0,17

KG 1,8 (NETTO)

5160		ORO FOGLIA	TULLE AVORIO ARRICCIATO		166,00	245,00
2075	187	ARGENTO FOGLIA	TULLE AVORIO ARRICCIATO		166,00	245,00
5162		NICHEL	TULLE AVORIO ARRICCIATO		166,00	245,00
5163		AVORIO	TULLE AVORIO ARRICCIATO		166,00	245,00
5164		PIOMBO	TULLE AVORIO ARRICCIATO		166,00	245,00
5165		ROSSO	TULLE AVORIO ARRICCIATO		166,00	245,00

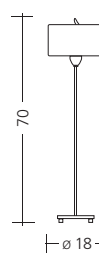

∅18X18 - H.10

1x
40W E.14
FORNITA

0,17

KG 1,7 (NETTO)

5170		ORO FOGLIA	TULLE AVORIO ARRICCIATO		166,00	245,00
2076	187	ARGENTO FOGLIA	TULLE AVORIO ARRICCIATO		166,00	245,00
5172		NICHEL	TULLE AVORIO ARRICCIATO		166,00	245,00
5173		AVORIO	TULLE AVORIO ARRICCIATO		166,00	245,00
5174		PIOMBO	TULLE AVORIO ARRICCIATO		166,00	245,00
5175		ROSSO	TULLE AVORIO ARRICCIATO		166,00	245,00

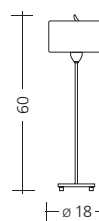

∅18X18 - H.10

1x
40W E.14
FORNITA

0,17

KG 1,6 (NETTO)

5180		ORO FOGLIA	TULLE AVORIO ARRICCIATO		166,00	245,00
2077	187	ARGENTO FOGLIA	TULLE AVORIO ARRICCIATO		166,00	245,00
5182		NICHEL	TULLE AVORIO ARRICCIATO		166,00	245,00
5183		AVORIO	TULLE AVORIO ARRICCIATO		166,00	245,00
5184		PIOMBO	TULLE AVORIO ARRICCIATO		166,00	245,00
5185		ROSSO	TULLE AVORIO ARRICCIATO		166,00	245,00

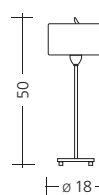

∅18X18 - H.10

1x
40W E.14
FORNITA

0,17

KG 1,5 (NETTO)

5190		ORO FOGLIA	TULLE AVORIO ARRICCIATO		166,00	245,00
2078	187	ARGENTO FOGLIA	TULLE AVORIO ARRICCIATO		166,00	245,00
5192		NICHEL	TULLE AVORIO ARRICCIATO		166,00	245,00
5193		AVORIO	TULLE AVORIO ARRICCIATO		166,00	245,00
5194		PIOMBO	TULLE AVORIO ARRICCIATO		166,00	245,00
5195		ROSSO	TULLE AVORIO ARRICCIATO		166,00	245,00

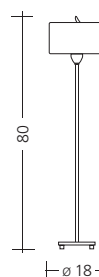

∅18X18 - H.10

1x
40W E.14
FORNITA

0,17

KG 1,8 (NETTO)

5120	185	ORO FOGLIA	TESSUTO ROSSO ARRICCIATO		166,00	245,00
5121		ARGENTO FOGLIA	TESSUTO ROSSO ARRICCIATO		166,00	245,00
5122		NICHEL	TESSUTO ROSSO ARRICCIATO		166,00	245,00
5123		AVORIO	TESSUTO ROSSO ARRICCIATO		166,00	245,00
5124		PIOMBO	TESSUTO ROSSO ARRICCIATO		166,00	245,00
5125		ROSSO	TESSUTO ROSSO ARRICCIATO		166,00	245,00

LAMPADARE DA TAVOLO

PIANTANE















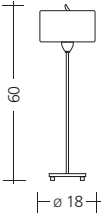



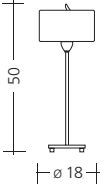



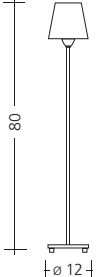

APPLIQUES

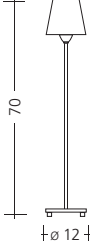
LAMPADARI E PLAFONIERE

COMPLEMENTI

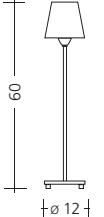
LOVELY LIGHT

BAGA

		ARTICOLO	PAG. CAT. RIFERIMENTO	FINITURA	PARALUME	PENDENTI	PREZZO €	
							SOLO BASE	COMPLETO
 <p>70 ∅ 18</p>	 ∅18X18 - H.10	5130	185	ORO FOGLIA	TESSUTO ROSSO ARRICCIATO		166,00	245,00
		5131		ARGENTO FOGLIA	TESSUTO ROSSO ARRICCIATO		166,00	245,00
	 1x 40W E.14 FORNITA	5132		NICHEL	TESSUTO ROSSO ARRICCIATO		166,00	245,00
		5133		AVORIO	TESSUTO ROSSO ARRICCIATO		166,00	245,00
	 0,17	5134		PIOMBO	TESSUTO ROSSO ARRICCIATO		166,00	245,00
		5135		ROSSO	TESSUTO ROSSO ARRICCIATO		166,00	245,00
							Kg 1,7 (NETTO)	
 <p>60 ∅ 18</p>	 ∅18X18 - H.10	5140	185	ORO FOGLIA	TESSUTO ROSSO ARRICCIATO		166,00	245,00
		5141		ARGENTO FOGLIA	TESSUTO ROSSO ARRICCIATO		166,00	245,00
	 1x 40W E.14 FORNITA	5142		NICHEL	TESSUTO ROSSO ARRICCIATO		166,00	245,00
		5143		AVORIO	TESSUTO ROSSO ARRICCIATO		166,00	245,00
	 0,17	5144		PIOMBO	TESSUTO ROSSO ARRICCIATO		166,00	245,00
		5145		ROSSO	TESSUTO ROSSO ARRICCIATO		166,00	245,00
							Kg 1,6 (NETTO)	
 <p>50 ∅ 18</p>	 ∅18X18 - H.10	5150	185	ORO FOGLIA	TESSUTO ROSSO ARRICCIATO		166,00	245,00
		5151		ARGENTO FOGLIA	TESSUTO ROSSO ARRICCIATO		166,00	245,00
	 1x 40W E.14 FORNITA	5152		NICHEL	TESSUTO ROSSO ARRICCIATO		166,00	245,00
		5153		AVORIO	TESSUTO ROSSO ARRICCIATO		166,00	245,00
	 0,17	5154		PIOMBO	TESSUTO ROSSO ARRICCIATO		166,00	245,00
		5155		ROSSO	TESSUTO ROSSO ARRICCIATO		166,00	245,00
							Kg 1,5 (NETTO)	
 <p>80 ∅ 12</p>	 ∅12X8 - H.11	5080		ORO FOGLIA	TULLE AVORIO ARRICCIATO		166,00	245,00
		5081		ARGENTO FOGLIA	TULLE AVORIO ARRICCIATO		166,00	245,00
	 1x 40W E.14 FORNITA	5082		NICHEL	TULLE AVORIO ARRICCIATO		166,00	245,00
		5083		AVORIO	TULLE AVORIO ARRICCIATO		166,00	245,00
	 0,17	5084		PIOMBO	TULLE AVORIO ARRICCIATO		166,00	245,00
		5085		ROSSO	TULLE AVORIO ARRICCIATO		166,00	245,00
							Kg 1,8 (NETTO)	
 <p>70 ∅ 12</p>	 ∅12X8 - H.11	5090		ORO FOGLIA	TULLE AVORIO ARRICCIATO		166,00	245,00
		5091		ARGENTO FOGLIA	TULLE AVORIO ARRICCIATO		166,00	245,00
	 1x 40W E.14 NON FORNITA	5092		NICHEL	TULLE AVORIO ARRICCIATO		166,00	245,00
		5093		AVORIO	TULLE AVORIO ARRICCIATO		166,00	245,00
	 0,17	5094		PIOMBO	TULLE AVORIO ARRICCIATO		166,00	245,00
		5095		ROSSO	TULLE AVORIO ARRICCIATO		166,00	245,00
							Kg 1,7 (NETTO)	
 <p>60 ∅ 12</p>	 ∅12X8 - H.11	5100		ORO FOGLIA	TULLE AVORIO ARRICCIATO		166,00	245,00
		5101		ARGENTO FOGLIA	TULLE AVORIO ARRICCIATO		166,00	245,00
	 1x 40W E.14 FORNITA	5102		NICHEL	TULLE AVORIO ARRICCIATO		166,00	245,00
		5103		AVORIO	TULLE AVORIO ARRICCIATO		166,00	245,00
	 0,17	5104		PIOMBO	TULLE AVORIO ARRICCIATO		166,00	245,00
		5105		ROSSO	TULLE AVORIO ARRICCIATO		166,00	245,00
							Kg 1,6 (NETTO)	

LOVELY LIGHT

BAGA

ARTICOLO PAG. CAT. RIFERIMENTO FINITURA PARALUME PENDENTI PREZZO € SOLO BASE COMPLETO

LAMPADARE DA TAVOLO

PIANTANE

APPLIQUES

LAMPADARI E PLAFONIERE

COMPLEMENTI

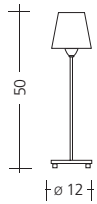



 ø12X8 - H.11

 1x
 40W E.14
 FORNITA

 0,17
 Kg 1,5 (NETTO)

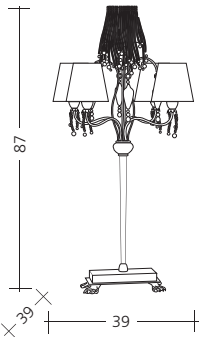
5110		ORO FOGLIA	TULLE AVORIO ARRICCIATO		166,00	245,00
5111		ARGENTO FOGLIA	TULLE AVORIO ARRICCIATO		166,00	245,00
5112		NICHEL	TULLE AVORIO ARRICCIATO		166,00	245,00
5113		AVORIO	TULLE AVORIO ARRICCIATO		166,00	245,00
5114		PIOMBO	TULLE AVORIO ARRICCIATO		166,00	245,00
5115		ROSSO	TULLE AVORIO ARRICCIATO		166,00	245,00





 ø12X8 - H.11

 5x
 40W E.14
 NON FORNITA

 0,40
 Kg 4,3 (NETTO)

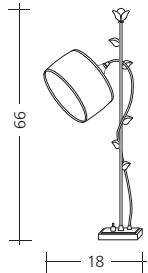
2125	179	ROSSO	TESSUTO ROSSO ARRICCIATO E CRISTALLI TRASPARENTI	CRISTALLI TRASPARENTI E PENDENTI COLOR ROSSO	890,00	1.356,00
-------------	-----	-------	--	--	--------	----------







 ø18X18 - H.10

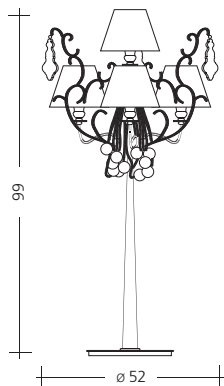









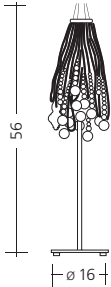

 1x
 40W E.14
 NON FORNITA

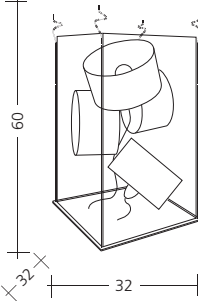
 0,17
 Kg 1,5 (NETTO)

2146	207	ORO FOGLIA	TULLE AVORIO ARRICCIATO	CRISTALLO TRASPARENTE	301,00	380,00
2147	209	NICHEL	TESSUTO ROSSO ARRICCIATO	CRISTALLO TRASPARENTE	343,00	422,00
2148	208	ARGENTO FOGLIA PARTICOLARI NICHEL	TESSUTO ROSSO ARRICCIATO	CRISTALLO TRASPARENTE	320,00	399,00

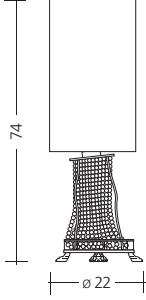

 ø12X8 - H.11

 ø16X9 - H.12

 4x
 40W E.14
 NON FORNITE

 0,64
 Kg 7,9 (NETTO)

2200	173	ORO FOGLIA	TULLE AVORIO ARRICCIATO	PENDENTI IN CRISTALLO COLOR AMBRA E PERLINE IN CRISTALLO TRASPARENTE	1.382,00	1.698,00
2201		ARGENTO FOGLIA	PVC	PENDENTI IN CRISTALLO TRASPARENTE E PERLINE IN CRISTALLO TRASPARENTE	1.382,00	1.698,00
2202	171	NICHEL	CARTA GIORNALE	PENDENTI IN METACRILATO TRASPARENTE E PERLINE IN CRISTALLO TRASPARENTE	1.382,00	1.698,00
2203		AVORIO	TULLE AVORIO ARRICCIATO	PENDENTI IN METACRILATO TRASPARENTE E PERLINE IN CRISTALLO TRASPARENTE	1.262,00	1.578,00
2204	170	PIOMBO	TESSUTO ROSSO ARRICCIATO	PENDENTI IN METACRILATO NERO E PERLINE IN CRISTALLO TRASPARENTE	1.262,00	1.578,00
2205		ROSSO	TULLE AVORIO ARRICCIATO	PENDENTI IN CRISTALLO COLOR ROSSO E PERLINE IN CRISTALLO TRASPARENTE	1.262,00	1.578,00

		ARTICOLO	PAG. CAT. RIFERIMENTO	FINITURA	PARALUME	PENDENTI	PREZZO €	
							SOLO BASE	COMPLETO
 <p>66 ø 16</p>	 1x 60W E14 ALOGENA FORNITA  0,17 Kg 2,4 (NETTO)	2292	167	NICHEL		PENDENTI IN CRISTALLO TRASPARENTE E PERLINE IN CRISTALLO TRASPARENTE		643,00
		2294	165	PIOMBO		PENDENTI IN METACRILATO NERO, IN CRISTALLO TRASPARENTE E PERLINE IN CRISTALLO TRASPARENTE		643,00
 <p>56 ø 16</p>	 1x 60W E14 ALOGENA FORNITA  0,17 Kg 2,3 (NETTO)	2302	167	NICHEL		PENDENTI IN CRISTALLO TRASPARENTE E PERLINE IN CRISTALLO TRASPARENTE		643,00
		2304	165	PIOMBO		PENDENTI IN METACRILATO NERO, IN CRISTALLO TRASPARENTE E PERLINE IN CRISTALLO TRASPARENTE		643,00
 <p>60 32 32</p>	 ø18X18 - H.10  4x 40W E.14 NON FORNITE  0,20 Kg 9,2 (NETTO)	2362	215	NICHEL PLEXIGLASS TRASPARENTE	<i>TESSUTO ROSSO ARRICCIATO</i>			1.095,00
 <p>74 ø 22</p>	 ø22X22 - H.38  1x 40W E.14  1x 60W E.27 NON FORNITE  0,22 Kg 4,1 (NETTO)	2382	221	NICHEL	<i>TULLE AVORIO ARRICCIATO</i>	CRISTALLI TRASPARENTI	699,00	838,00
		2384	219	PIOMBO	<i>TESSUTO ROSSO ARRICCIATO</i>	CRISTALLI TRASPARENTI	619,00	758,00

LOVELY LIGHT

BAGA

ARTICOLO PAG. CAT. RIFERIMENTO FINITURA PARALUME PENDENTI PREZZO € SOLO BASE COMPLETO

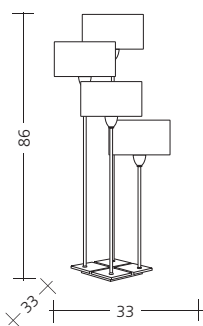

Ø18X18 - H.10

4x
40W E.14
NON FORNITE

0,54

Kg 3,4 (NETTO)

2450/R		ORO FOGLIA	CILINDRO IN TESSUTO ROSSO ARRICCIATO		556,00	872,00
2451/R		ARGENTO FOGLIA	CILINDRO IN TESSUTO ROSSO ARRICCIATO		556,00	872,00
2452/R		NICHEL	CILINDRO IN TESSUTO ROSSO ARRICCIATO		606,00	922,00
2453/R		AVORIO	CILINDRO IN TESSUTO ROSSO ARRICCIATO		516,00	832,00
2454/R	193	PIOMBO	CILINDRO IN TESSUTO ROSSO ARRICCIATO		516,00	832,00
2455/R	192	ROSSO	CILINDRO IN TESSUTO ROSSO ARRICCIATO		516,00	832,00

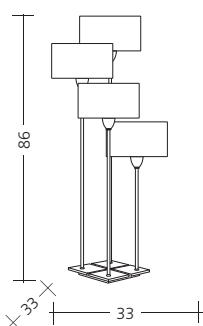

Ø18X18 - H.10

4x
40W E.14
NON FORNITE

0,54

Kg 3,4 (NETTO)

2450/A		ORO FOGLIA	CILINDRO IN TULLE AVORIO ARRICCIATO		556,00	872,00
2451/A		ARGENTO FOGLIA	CILINDRO IN TULLE AVORIO ARRICCIATO		556,00	872,00
2452/A		NICHEL	CILINDRO IN TULLE AVORIO ARRICCIATO		606,00	922,00
2453/A		AVORIO	CILINDRO IN TULLE AVORIO ARRICCIATO		516,00	832,00
2454/A	196	PIOMBO	CILINDRO IN TULLE AVORIO ARRICCIATO		516,00	832,00
2455/A	197	ROSSO	CILINDRO IN TULLE AVORIO ARRICCIATO		516,00	832,00

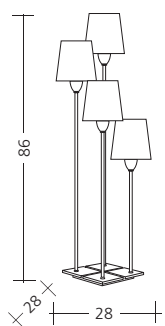

Ø12X8 - H.11

4x
40W E.14
NON FORNITE

0,54

Kg 3,4 (NETTO)

2450/P		ORO FOGLIA	CONO IN TESSUTO ROSSO ARRICCIATO		556,00	872,00
2451/P		ARGENTO FOGLIA	CONO IN TESSUTO ROSSO ARRICCIATO		556,00	872,00
2452/P	195	NICHEL	CONO IN TESSUTO ROSSO ARRICCIATO		606,00	922,00
2453/P		AVORIO	CONO IN TESSUTO ROSSO ARRICCIATO		516,00	832,00
2454/P	194	PIOMBO	CONO IN TESSUTO ROSSO ARRICCIATO		516,00	832,00
2455/P		ROSSO	CONO IN TESSUTO ROSSO ARRICCIATO		516,00	832,00

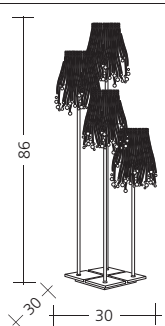

Ø14X10 - H.24

4x
40W E.14
NON FORNITE

0,54

Kg 7,3 (NETTO)

2450/C		ORO FOGLIA	CRISTALLI TRASPARENTI		556,00	1.204,00
2451/C		ARGENTO FOGLIA	CRISTALLI TRASPARENTI		556,00	1.204,00
2452/C	199	NICHEL	CRISTALLI TRASPARENTI		606,00	1.254,00
2453/C		AVORIO	CRISTALLI TRASPARENTI		516,00	1.164,00
2454/C	198	PIOMBO	CRISTALLI TRASPARENTI		516,00	1.164,00
2455/C		ROSSO	CRISTALLI TRASPARENTI		516,00	1.164,00

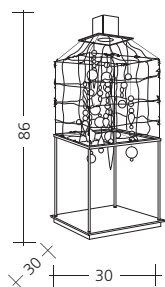

1x
75W GU10
FORNITA

0,19

Kg 5,7 (NETTO)

2492	213	NICHEL PARTICOLARI FERRO	CRISTALLI TRASPARENTI PENDENTI COLORATI			1.480,00
------	-----	-----------------------------	--	--	--	----------

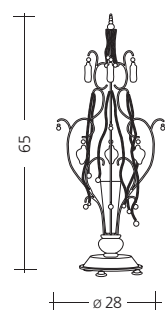

1x
60W G9
FORNITA

0,17

Kg 3,1 (NETTO)

2100		ORO FOGLIA	PENDENTI COLOR AMBRA CON CRISTALLI TRASPARENTI			742,00
2101		ROSSO	PENDENTI COLOR ROSSO CON CRISTALLI TRASPARENTI			742,00
2102	153	ARGENTO FOGLIA	PENDENTI E CRISTALLI TRASPARENTI			742,00

LAMPADARE DA TAVOLO

PIANTANE

APPLIQUES

LAMPADARI E PLAFONIERE

COMPLEMENTI

LOVELY LIGHT

BAGA

ARTICOLO PAG. CAT. RIFERIMENTO FINITURA PARALUME PENDENTI PREZZO € SOLO BASE COMPLETO

LAMPADE DA TAVOLO

PIANTANE

APPLIQUES

LAMPADARI E PLAFONIERE

COMPLEMENTI

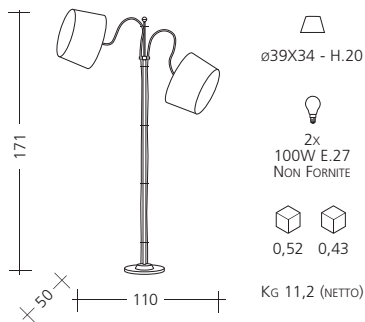

683

261

OTTONE
PARTICOLARI FERRO

PAGLIA

1.117,00

1.325,00

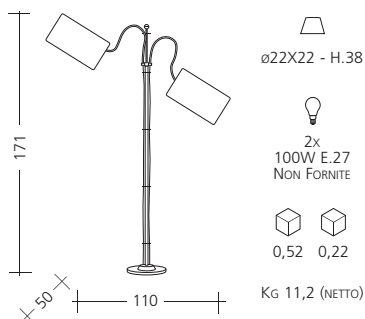

685

262

PIOMBO
PARTICOLARI NICHEL

TESSUTO ROSSO
ARRICCIATO

1.198,00

1.454,00

686

263

NICHEL

TULLE AVORIO
ARRICCIATO

1.219,00

1.475,00

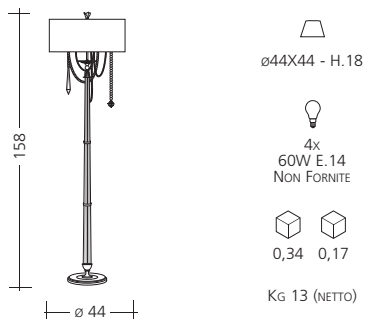

1046

255

NICHEL PARTICOLARI
ARGENTO FOGLIA

TULLE AVORIO
ARRICCIATO E
CRISTALLI TRASPARENTI

1.085,00

1.430,00

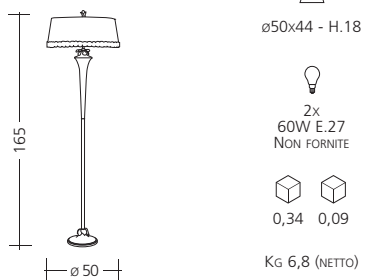

2055

235

AVORIO
PARTICOLARI
ARGENTO FOGLIA

CARTA BIANCA
INTRECCIATA

691,00

824,00

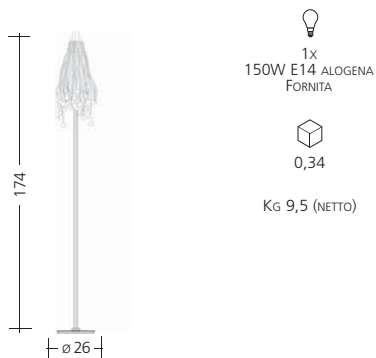

2312

239

NICHEL

PENDENTI IN CRISTALLO
TRASPARENTE
E PERLINE IN CRISTALLO
TRASPARENTE

1.290,00











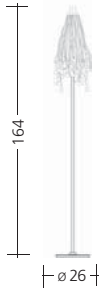

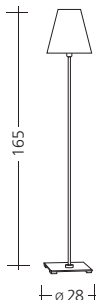



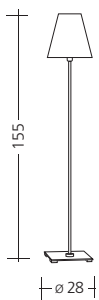

2314

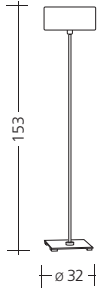
241

PIOMBO

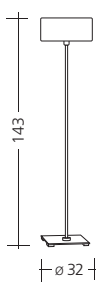
PENDENTI IN METACRILATO
NERO,
IN CRISTALLO TRASPARENTE
E PERLINE
IN CRISTALLO TRASPARENTE

1.215,00

		ARTICOLO	PAG. CAT. RIFERIMENTO	FINITURA	PARALUME	PENDENTI	PREZZO €	
							SOLO BASE	COMPLETO
	 1x 150W E14 ALOGENA FORNITA  0,34 KG 9,3 (NETTO)	2322	239	NICHEL		PENDENTI IN CRISTALLO TRASPARENTE E PERLINE IN CRISTALLO TRASPARENTE		1.290,00
		2324	241	PIOMBO		PENDENTI IN METACRILATO NERO, IN CRISTALLO TRASPARENTE E PERLINE IN CRISTALLO TRASPARENTE		1.215,00
	 ø28X14 - H.28  1x 60W E.14 NON FORNITA  0,34 KG 6,8 (NETTO)	2317	243	ORO FOGLIA	TULLE AVORIO ARRICCIATO		520,00	648,00
		6061		ARGENTO FOGLIA	TULLE AVORIO ARRICCIATO		520,00	648,00
		2316		NICHEL	TULLE AVORIO ARRICCIATO		595,00	723,00
		6063		AVORIO	TULLE AVORIO ARRICCIATO		520,00	648,00
		2318		PIOMBO	TULLE AVORIO ARRICCIATO		520,00	648,00
		6065		ROSSO	TULLE AVORIO ARRICCIATO		520,00	648,00
	 ø28X14 - H.28  1x 60W E.14 NON FORNITA  0,34 KG 6,5 (NETTO)	2327	245	ORO FOGLIA	TULLE AVORIO ARRICCIATO		520,00	648,00
		6051		ARGENTO FOGLIA	TULLE AVORIO ARRICCIATO		520,00	648,00
		2326		NICHEL	TULLE AVORIO ARRICCIATO		595,00	723,00
		6053		AVORIO	TULLE AVORIO ARRICCIATO		520,00	648,00
		2328		PIOMBO	TULLE AVORIO ARRICCIATO		520,00	648,00
		6055		ROSSO	TULLE AVORIO ARRICCIATO		520,00	648,00
	 ø32X32 - H.14  1x 60W E.14 NON FORNITA  0,34 KG 6,8 (NETTO)	2337	245	ORO FOGLIA	TULLE AVORIO ARRICCIATO		520,00	648,00
		6021		ARGENTO FOGLIA	TULLE AVORIO ARRICCIATO		520,00	648,00
		2336		NICHEL	TULLE AVORIO ARRICCIATO		595,00	723,00
		6023		AVORIO	TULLE AVORIO ARRICCIATO		520,00	648,00
		2338		PIOMBO	TULLE AVORIO ARRICCIATO		520,00	648,00
		6025		ROSSO	TULLE AVORIO ARRICCIATO		520,00	648,00
	 ø32X32 - H.14  1x 60W E.14 NON FORNITA  0,34 KG 6,5 (NETTO)	2347	245	ORO FOGLIA	TULLE AVORIO ARRICCIATO		520,00	648,00
		6011		ARGENTO FOGLIA	TULLE AVORIO ARRICCIATO		520,00	648,00
		2346		NICHEL	TULLE AVORIO ARRICCIATO		595,00	723,00
		6013		AVORIO	TULLE AVORIO ARRICCIATO		520,00	648,00
		2348		PIOMBO	TULLE AVORIO ARRICCIATO		520,00	648,00
		6015		ROSSO	TULLE AVORIO ARRICCIATO		520,00	648,00

LOVELY LIGHT

BAGA

ARTICOLO PAG. CAT. RIFERIMENTO FINITURA PARALUME PENDENTI PREZZO € SOLO BASE COMPLETO

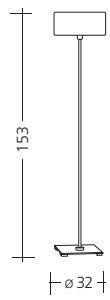

 $\varnothing 32 \times 32$ - H.14
 1x 60W E.14 NON FORNITA
 0,34
 Kg 6,8 (NETTO)

6040		ORO FOGLIA	TESSUTO ROSSO ARRICCIATO		520,00	648,00
6041		ARGENTO FOGLIA	TESSUTO ROSSO ARRICCIATO		520,00	648,00
6042		NICHEL	TESSUTO ROSSO ARRICCIATO		595,00	723,00
6043		AVORIO	TESSUTO ROSSO ARRICCIATO		520,00	648,00
6044		PIOMBO	TESSUTO ROSSO ARRICCIATO		520,00	648,00
6045		ROSSO	TESSUTO ROSSO ARRICCIATO		520,00	648,00

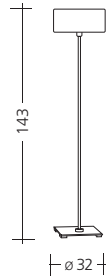

 $\varnothing 32 \times 32$ - H.14
 1x 60W E.14 NON FORNITA
 0,34
 Kg 6,5 (NETTO)

6030		ORO FOGLIA	TESSUTO ROSSO ARRICCIATO		520,00	648,00
6031		ARGENTO FOGLIA	TESSUTO ROSSO ARRICCIATO		520,00	648,00
6032		NICHEL	TESSUTO ROSSO ARRICCIATO		595,00	723,00
6033		AVORIO	TESSUTO ROSSO ARRICCIATO		520,00	648,00
6034		PIOMBO	TESSUTO ROSSO ARRICCIATO		520,00	648,00
6035		ROSSO	TESSUTO ROSSO ARRICCIATO		520,00	648,00

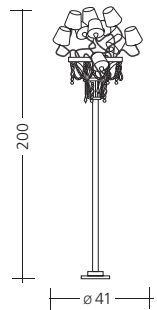

 $\varnothing 16 \times 9$ - H.12
 $\varnothing 12 \times 8$ - H.11
 12x 40W E.14 NON FORNITE
 0,52
 Kg 21 (NETTO)

2434/N		PIOMBO FLESSIBILI NICHEL	TESSUTO NERO INTERNO ALLUMINIO	CRISTALLI TRASPARENTI PENDENTI TRASPARENTI E METACRILATO NERO	1.880,00	2.576,00
2434	267	PIOMBO FLESSIBILI NICHEL	TESSUTO ROSSO ARRICCIATO	CRISTALLI TRASPARENTI PENDENTI TRASPARENTI E METACRILATO NERO	1.880,00	2.828,00
2435		ROSSO FLESSIBILI NICHEL	RETE NERA ELASTICIZZATA	CRISTALLI TRASPARENTI PENDENTI ROSSO E AMETISTA	1.880,00	2.900,00

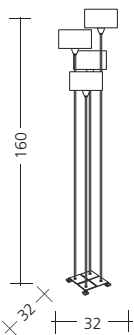

 $\varnothing 18 \times 18$ - H.10
 4x 40W E.14 NON FORNITE
 0,34
 Kg 4,7 (NETTO)

2460/R		ORO FOGLIA	CILINDRO IN TESSUTO ROSSO ARRICCIATO		880,00	1.196,00
2461/R		ARGENTO FOGLIA	CILINDRO IN TESSUTO ROSSO ARRICCIATO		880,00	1.196,00
2462/R		NICHEL	CILINDRO IN TESSUTO ROSSO ARRICCIATO		930,00	1.246,00
2463/R		AVORIO	CILINDRO IN TESSUTO ROSSO ARRICCIATO		740,00	1.056,00
2464/R	249	PIOMBO	CILINDRO IN TESSUTO ROSSO ARRICCIATO		740,00	1.056,00
2465/R		ROSSO	CILINDRO IN TESSUTO ROSSO ARRICCIATO		740,00	1.056,00

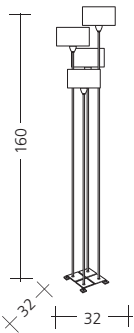

 $\varnothing 18 \times 18$ - H.10
 4x 40W E.14 NON FORNITE
 0,34
 Kg 4,7 (NETTO)

2460/A		ORO FOGLIA	CILINDRO IN TULLE AVORIO ARRICCIATO		880,00	1.196,00
2461/A		ARGENTO FOGLIA	CILINDRO IN TULLE AVORIO ARRICCIATO		880,00	1.196,00
2462/A		NICHEL	CILINDRO IN TULLE AVORIO ARRICCIATO		930,00	1.296,00
2463/A		AVORIO	CILINDRO IN TULLE AVORIO ARRICCIATO		740,00	1.056,00
2464/A	247	PIOMBO	CILINDRO IN TULLE AVORIO ARRICCIATO		740,00	1.056,00
2465/A		ROSSO	CILINDRO IN TULLE AVORIO ARRICCIATO		740,00	1.056,00

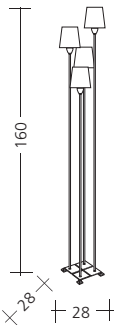

 $\varnothing 12 \times 8$ - H.11
 4x 40W E.14 NON FORNITE
 0,34
 Kg 4,7 (NETTO)

2460/P		ORO FOGLIA	CONO IN TESSUTO ROSSO ARRICCIATO		880,00	1.196,00
2461/P		ARGENTO FOGLIA	CONO IN TESSUTO ROSSO ARRICCIATO		880,00	1.196,00
2462/P		NICHEL	CONO IN TESSUTO ROSSO ARRICCIATO		930,00	1.296,00
2463/P		AVORIO	CONO IN TESSUTO ROSSO ARRICCIATO		740,00	1.056,00
2464/P	251	PIOMBO	CONO IN TESSUTO ROSSO ARRICCIATO		740,00	1.056,00
2465/P		ROSSO	CONO IN TESSUTO ROSSO ARRICCIATO		740,00	1.056,00

LAMPADARE DA TAVOLO

PIANTANE

APPLIQUES

LAMPADARI E PLAFONIERE

COMPLEMENTI

LOVELY LIGHT

BAGA

ARTICOLO PAG. CAT. RIFERIMENTO FINITURA PARALUME PENDENTI PREZZO € SOLO BASE COMPLETO

LAMPADE DA TAVOLO

PIANTANE

APPLIQUES

LAMPADARI E PLAFONIERE

COMPLEMENTI

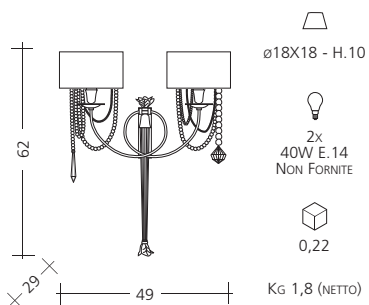

ø18x18 - H.10
2x
40W E.14
NON FORNITE
0,22
Kg 1,8 (NETTO)

1044

297

NICHEL PARTICOLARI
ARGENTO FOGLIA

TULLE AVORIO
ARRICCIATO E
CRISTALLI TRASPARENTI

613,00

945,00

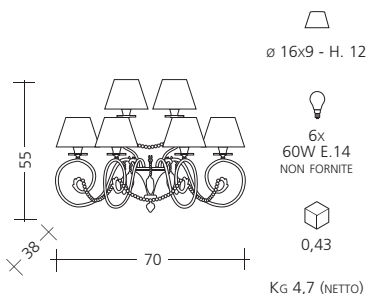

ø 16x9 - H. 12
6x
60W E. 14
NON FORNITE
0,43
Kg 4,7 (NETTO)

1185

281

ARGENTO FOGLIA

CARTA NERA
INTRECCIATA

PENDENTI COLOR AMETISTA
CON PERLE TRASPARENTI

672,00

990,00

1183

280

ORO FOGLIA

CARTA NATURALE
INTRECCIATA

PENDENTI COLOR AMETISTA
CON PERLE TRASPARENTI

672,00

990,00

1187

279

ROSSO

TESSUTO BIANCO

PENDENTI COLOR ROSSO
CON PERLE TRASPARENTI

672,00

990,00

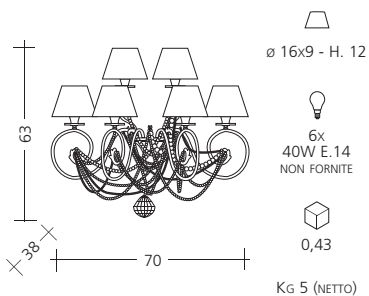

ø 16x9 - H. 12
6x
40W E. 14
NON FORNITE
0,43
Kg 5 (NETTO)

1189

277

ROSSO

TULLE AVORIO
ARRICCIATO

CRISTALLI TRASPARENTI

1.305,00

1.695,00

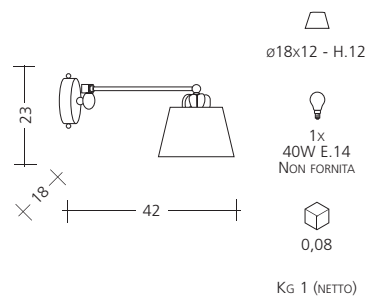

ø18x12 - H.12
1x
40W E.14
NON FORNITA
0,08
Kg 1 (NETTO)

2051

316

AVORIO / NICHEL
PARTICOLARI
ARGENTO FOGLIA

CARTA BIANCA
INTRECCIATA

338,00

418,00

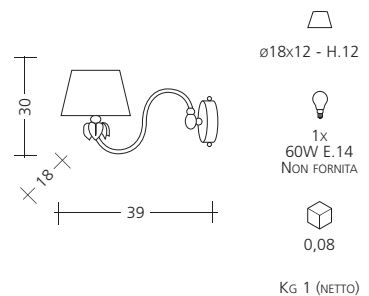

ø18x12 - H.12
1x
60W E.14
NON FORNITA
0,08
Kg 1 (NETTO)

2052

314

AVORIO / NICHEL
PARTICOLARI
ARGENTO FOGLIA

CARTA BIANCA
INTRECCIATA

338,00

418,00

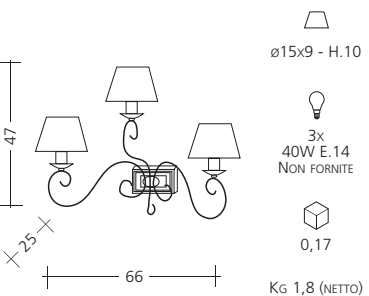

ø15x9 - H.10
3x
40W E. 14
NON FORNITE
0,17
Kg 1,8 (NETTO)

2053

316

AVORIO / NICHEL

CARTA BIANCA
INTRECCIATA

624,00

840,00

	ARTICOLO	PAG. CAT. RIFERIMENTO	FINITURA	PARALUME	PENDENTI	PREZZO € SOLO BASE	PREZZO € COMPLETO
	2054	314	AVORIO / NICHEL	CARTA BIANCA INTRECCIATA		554,00	698,00
	2057	299	NICHEL	TULLE AVORIO ARRICCIATO	CRISTALLI TRASPARENTI	635,00	891,00
	2091	98	ROSSO	TESSUTO NERO	PENDENTI COLOR ROSSO E CRISTALLI TRASPARENTI	200,00	302,00
	1121	98	AVORIO ANTICATO	RETE SIMILPELLE BIANCA	CRISTALLI TRASPARENTI	196,00	320,00
	1131	98	ARGENTO FOGLIA	CARTA BEIGE E NERA INTRECCIATA	CRISTALLI TRASPARENTI	196,00	268,00
	1141	98	ORO FOGLIA	TAFFETÀ VERDE E AVORIO	CRISTALLI TRASPARENTI E AMETISTA	196,00	288,00
	2140	303	NICHEL	TESSUTO ROSSO ARRICCIATO		191,00	270,00
	2142	310	NICHEL	SETA BIANCA E CRISTALLI TRASPARENTI		191,00	316,00

LOVELY LIGHT

BAGA

ARTICOLO PAG. CAT. RIFERIMENTO FINITURA PARALUME PENDENTI PREZZO € SOLO BASE COMPLETO

LAMPADE DA TAVOLO

PIANTANE

APPLIQUES

LAMPADARI E PLAFONIERE

COMPLEMENTI

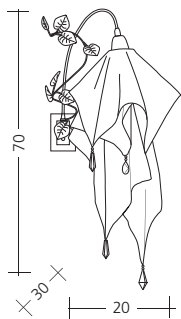

ø10x6 - H.12
1x 40W E.14 NON FORNITA
0,08
KG 1 (NETTO)

2143
2143/V

308
310
NICHEL
NICHEL

SETA IN TRE COLORI (ROSSO, ARANCIO E BIANCO) E CRISTALLI TRASPARENTI
SETA IN TRE COLORI (VERDE, ARANCIO E BIANCO) E CRISTALLI TRASPARENTI

191,00
191,00
350,00
350,00

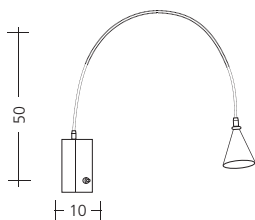

1x 1 W LED FORNITA
0,08
KG 1 (NETTO)

2141

305
NICHEL

DIFFUSORE IN METALLO CON POLICARBONATO

348,00

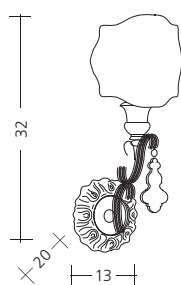

ø12x8 - H.11
ø13 - H.13
1x 40W E.14 NON FORNITA
0,08
KG 1,1 (NETTO)

2210
2211
2212
2213
2214
2215

295
ARGENTO FOGLIA
294
NICHEL
AVORIO
PIOMBO
ROSSO

PARALUME TULLE AVORIO ARRICCIATO
VENTOLA IN PVC
VENTOLA IN CARTA GIORNALE
PARALUME TULLE AVORIO ARRICCIATO
VENTOLA IN PVC
PARALUME TULLE AVORIO ARRICCIATO

PENDENTI IN CRISTALLO COLOR AMBRA E PERLINE IN CRISTALLO TRASPARENTE
PENDENTI IN CRISTALLO TRASPARENTE E PERLINE IN CRISTALLO TRASPARENTE
PENDENTI IN METACRILATO TRASPARENTE E PERLINE IN CRISTALLO TRASPARENTE
PENDENTI IN METACRILATO TRASPARENTE E PERLINE IN CRISTALLO TRASPARENTE
PENDENTI IN METACRILATO NERO E PERLINE IN CRISTALLO TRASPARENTE
PENDENTI IN CRISTALLO COLOR ROSSO E PERLINE IN CRISTALLO TRASPARENTE

278,00
278,00
278,00
261,00
261,00
261,00
356,00
325,00
325,00
340,00
325,00
340,00

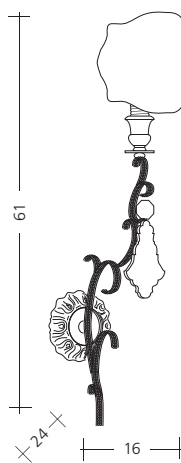

ø16 - H.15
ø12x8 - H.11
1x 40W E.14 NON FORNITA
0,17
KG 1,4 (NETTO)

2220
2221
2222
2223
2224
2225

Oro FOGLIA
ARGENTO FOGLIA
NICHEL
AVORIO
PIOMBO
ROSSO

PARALUME TULLE AVORIO ARRICCIATO
VENTOLA IN PVC
VENTOLA IN CARTA GIORNALE
PARALUME TULLE AVORIO ARRICCIATO
VENTOLA IN PVC
PARALUME TULLE AVORIO ARRICCIATO

PENDENTI IN CRISTALLO COLOR AMBRA E PERLINE IN CRISTALLO TRASPARENTE
PENDENTI IN CRISTALLO TRASPARENTE E PERLINE IN CRISTALLO TRASPARENTE
PENDENTI IN METACRILATO TRASPARENTE E PERLINE IN CRISTALLO TRASPARENTE
PENDENTI IN METACRILATO TRASPARENTE E PERLINE IN CRISTALLO TRASPARENTE
PENDENTI IN METACRILATO NERO E PERLINE IN CRISTALLO TRASPARENTE
PENDENTI IN CRISTALLO COLOR ROSSO E PERLINE IN CRISTALLO TRASPARENTE

379,00
379,00
379,00
356,00
356,00
356,00
458,00
426,00
426,00
435,00
403,00
435,00

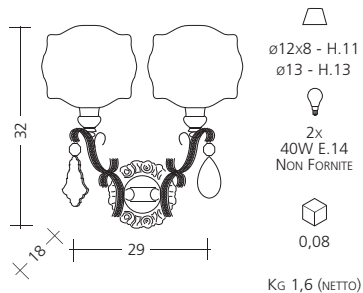

2230	289	ORO FOGLIA	PARALUME TULLE AVORIO ARRICCIATO	PENDENTI IN CRISTALLO COLOR AMBRA E PERLINE IN CRISTALLO TRASPARENTE	436,00	594,00
2231		ARGENTO FOGLIA	VENTOLA IN PVC	PENDENTI IN CRISTALLO TRASPARENTE E PERLINE IN CRISTALLO TRASPARENTE	436,00	530,00
2232		NICHEL	VENTOLA IN CARTA GIORNALE	PENDENTI IN METACRILATO TRASPARENTE E PERLINE IN CRISTALLO TRASPARENTE	436,00	530,00
2233	288	AVORIO	PARALUME TULLE AVORIO ARRICCIATO	PENDENTI IN METACRILATO TRASPARENTE E PERLINE IN CRISTALLO TRASPARENTE	426,00	584,00
2234		PIOMBO	VENTOLA IN PVC	PENDENTI IN METACRILATO NERO, CRISTALLO TRASPARENTE E PERLINE IN CRISTALLO TRASPARENTE	426,00	520,00
2235		ROSSO	PARALUME TULLE AVORIO ARRICCIATO	PENDENTI IN CRISTALLO COLOR ROSSO E PERLINE IN CRISTALLO TRASPARENTE	426,00	584,00

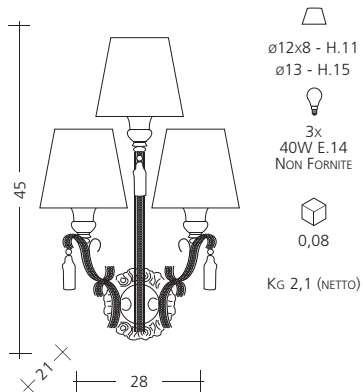

2240	290	ORO FOGLIA	PARALUME TULLE AVORIO ARRICCIATO	PENDENTI IN CRISTALLO COLOR AMBRA E PERLINE IN CRISTALLO TRASPARENTE	578,00	815,00
2241		ARGENTO FOGLIA	VENTOLA IN PVC	PENDENTI IN CRISTALLO TRASPARENTE E PERLINE IN CRISTALLO TRASPARENTE	578,00	719,00
2242		NICHEL	VENTOLA IN CARTA GIORNALE	PENDENTI IN METACRILATO TRASPARENTE E PERLINE IN CRISTALLO TRASPARENTE	578,00	719,00
2243		AVORIO	PARALUME TULLE AVORIO ARRICCIATO	PENDENTI IN METACRILATO TRASPARENTE E PERLINE IN CRISTALLO TRASPARENTE	566,00	803,00
2244	291	PIOMBO	VENTOLA IN PVC	PENDENTI IN METACRILATO NERO, E PERLINE IN CRISTALLO TRASPARENTE	566,00	707,00
2245		ROSSO	PARALUME TULLE AVORIO ARRICCIATO	PENDENTI IN CRISTALLO COLOR ROSSO E PERLINE IN CRISTALLO TRASPARENTE	566,00	803,00

LOVELY LIGHT

BAGA

ARTICOLO PAG. CAT. RIFERIMENTO FINITURA PARALUME PENDENTI PREZZO € SOLO BASE COMPLETO

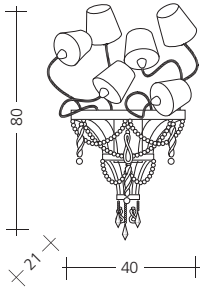



 ø16x9 - H.12
 ø12x8 - H.11



 6x
 40W E.14
 NON FORNITE



 0,22

 Kg 4 (NETTO)

2444/N	271	PIOMBO FLESSIBILI NICHEL	TESSUTO NERO INTERNO ALLUMINIO	CRISTALLI TRASPARENTI PENDENTI TRASPARENTI E METACRILATO NERO	992,00	1.358,00
2444	273	PIOMBO FLESSIBILI NICHEL	TESSUTO ROSSO ARRICCIATO	CRISTALLI TRASPARENTI PENDENTI TRASPARENTI E METACRILATO NERO	992,00	1.476,00
2445		ROSSO FLESSIBILI NICHEL	RETE NERA ELASTICIZZATA	CRISTALLI TRASPARENTI PENDENTI ROSSO E AMETISTA	992,00	1.468,00

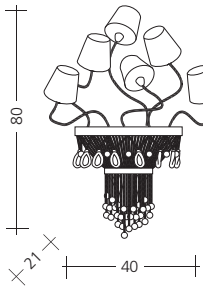



 ø12x8 - H.11



 6x
 40W E.14
 NON FORNITE



 0,22

 Kg 5,6 (NETTO)

2446	275	AVORIO FLESSIBILI NICHEL	TULLE AVORIO ARRICCIATO	CRISTALLI E PENDENTI TRASPARENTI	1.514,00	1.988,00
-------------	-----	-----------------------------	----------------------------	-------------------------------------	-----------------	-----------------

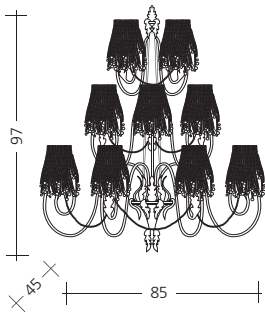



 ø14X10 - H.24



 9x
 40W E.14
 NON FORNITE



 0,86

 Kg 25 (NETTO)

3083	285	ORO FOGLIA	CRISTALLI TRASPARENTI	CRISTALLI TRASPARENTI	1.976,00	3.272,00
-------------	-----	------------	-----------------------	-----------------------	-----------------	-----------------

LAMPADE DA TAVOLO

PIANTANE

APPLIQUES

LAMPADARI E PLAFONIERE

COMPLEMENTI

LOVELY LIGHT

BAGA

ARTICOLO PAG. CAT. RIFERIMENTO FINITURA PARALUME PENDENTI PREZZO € SOLO BASE COMPLETO

LAMPADARE DA TAVOLO

PIANTANE

APPLIQUES

LAMPADARI E PLAFONIERE

COMPLEMENTI

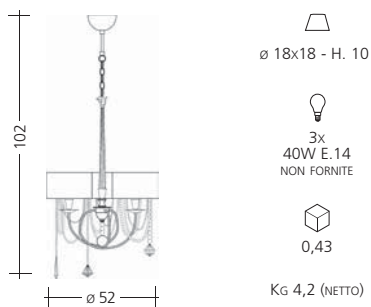

1045

9

NICHEL PARTICOLARI
ARGENTO FOGLIA

TULLE AVORIO
ARRICCIATO E
CRISTALLI TRASPARENTI

828,00

1.326,00

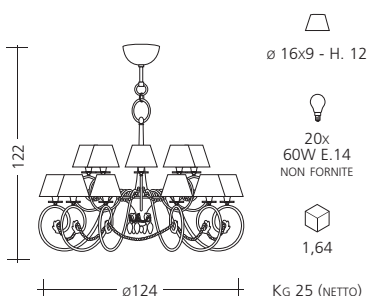

1182

107

ARGENTO FOGLIA

CARTA NERA
INTRECCIATA

PENDENTI COLOR AMETISTA
CON PERLE TRASPARENTI

3.742,00

5.182,00

1184

106

ORO FOGLIA

CARTA NATURALE
INTRECCIATA

PENDENTI COLOR AMETISTA
CON PERLE TRASPARENTI

3.742,00

5.182,00

1186

7

ROSSO

TESSUTO BIANCO

PENDENTI COLOR ROSSO
CON PERLE TRASPARENTI

3.742,00

5.182,00

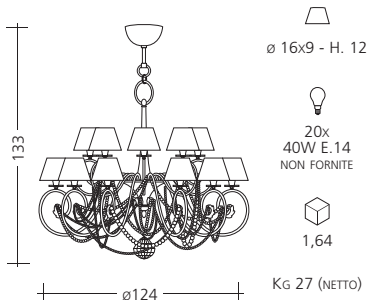

1188

5

ROSSO

TULLE AVORIO
ARRICCIATO

CRISTALLI TRASPARENTI

4.762,00

6.062,00

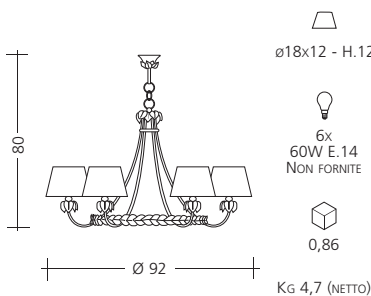

2050

93

AVORIO / NICHEL
PARTICOLARI
ARGENTO FOGLIA

CARTA BIANCA
INTRECCIATA

1.038,00

1.518,00

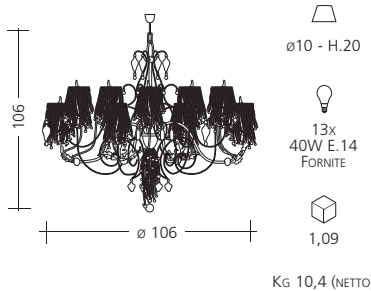

2060

32

ROSSO

CRISTALLI TRASPARENTI

PENDENTI COLOR ROSSO
E CRISTALLI TRASPARENTI

4.380,00

2070

33

ARGENTO FOGLIA

CRISTALLI TRASPARENTI

CRISTALLI TRASPARENTI

4.380,00

2080

35

ORO FOGLIA

CRISTALLI TRASPARENTI

PENDENTI COLOR AMBRA
E CRISTALLI TRASPARENTI

4.380,00

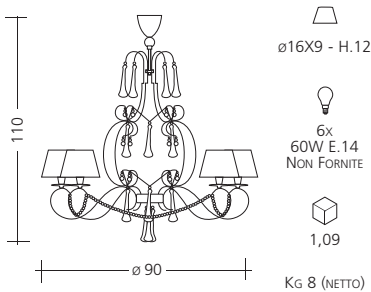

2090

95

ROSSO

TESSUTO NERO

PENDENTI COLOR ROSSO
CON CRISTALLI
TRASPARENTI

1.750,00

2.362,00

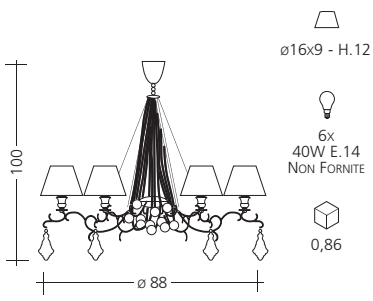
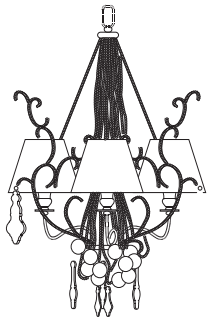
ARTICOLO	PAG. CAT. RIFERIMENTO	FINITURA	PARALUME	PENDENTI	PREZZO €	
					SOLO BASE	COMPLETO
	2250	ORO FOGLIA	TULLE AVORIO ARRICCIATO	PENDENTI IN CRISTALLO COLOR AMBRA E PERLINE IN CRISTALLO TRASPARENTE	2.462,00	2.936,00
	2251	ARGENTO FOGLIA	PVC	PENDENTI IN CRISTALLO TRASPARENTE E PERLINE IN CRISTALLO TRASPARENTE	2.462,00	2.810,00
	2252	NICHEL	CARTA GIORNALE	PENDENTI IN METACRILATO TRASPARENTE E PERLINE IN CRISTALLO TRASPARENTE	2.462,00	2.810,00
	2253	AVORIO	TULLE AVORIO ARRICCIATO	PENDENTI IN METACRILATO TRASPARENTE E PERLINE IN CRISTALLO TRASPARENTE	2.074,00	2.548,00
	2254	PIOMBO	PVC	PENDENTI IN METACRILATO NERO E PERLINE IN CRISTALLO TRASPARENTE	2.074,00	2.422,00
	2255	ROSSO	TULLE AVORIO ARRICCIATO	PENDENTI IN CRISTALLO COLOR ROSSO E PERLINE IN CRISTALLO TRASPARENTE	2.074,00	2.548,00
	2260	ORO FOGLIA	TULLE AVORIO ARRICCIATO	PENDENTI IN CRISTALLO COLOR AMBRA E PERLINE IN CRISTALLO TRASPARENTE	1.362,00	1.599,00
	2261	ARGENTO FOGLIA	PVC	PENDENTI IN CRISTALLO TRASPARENTE E PERLINE IN CRISTALLO TRASPARENTE	1.362,00	1.536,00
	2262	NICHEL	CARTA GIORNALE	PENDENTI IN METACRILATO TRASPARENTE E PERLINE IN CRISTALLO TRASPARENTE	1.362,00	1.536,00
	2263	AVORIO	TULLE AVORIO ARRICCIATO	PENDENTI IN METACRILATO TRASPARENTE E PERLINE IN CRISTALLO TRASPARENTE	1.218,00	1.455,00
	2264	PIOMBO	PVC	PENDENTI IN METACRILATO NERO E PERLINE IN CRISTALLO TRASPARENTE	1.218,00	1.392,00
	2265	ROSSO	TULLE AVORIO ARRICCIATO	PENDENTI IN CRISTALLO COLOR ROSSO E PERLINE IN CRISTALLO TRASPARENTE	1.218,00	1.455,00